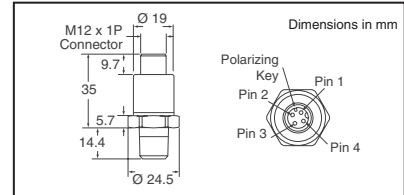

Fig.	Compression/Tension Range (Lbf)	Excitation (VDC)	Output Span Voltage @ ±5% Tolerance	Storage/Operating Temperature Range	Digi-Key Part No.	1	Price Each	10	100	Measurement Part No.
1	10	3.3 - 5.0	0.5 - 4.5 V	-40°C - 85°C	MSP6948-ND	40.37	32.52	24.96		FC2231-0000-0010-L
	25	3.3 - 5.0	0.5 - 4.5 V	-40°C - 85°C	MSP6949-ND	40.37	32.52	24.96		FC2231-0000-0025-L
	50	3.3 - 5.0	0.5 - 4.5 V	-40°C - 85°C	MSP6950-ND	40.37	32.52	24.96		FC2231-0000-0050-L
2	250	5.0	10.0 mV/V	-40°C - 85°C	MSP6952-ND	80.99	62.57	50.81		FC2311-0000-0250-L
	500	5.0	10.0 mV/V	-40°C - 85°C	MSP6953-ND	80.99	62.59	50.81		FC2311-0000-0500-L
	1000	5.0	10.0 mV/V	-40°C - 85°C	MSP6954-ND	80.99	62.57	50.81		FC2311-0000-1000-L
	2000	5.0	10.0 mV/V	-40°C - 85°C	MSP6955-ND	80.99	62.59	50.81		FC2311-0000-2000-L

Senstronics Sensors with Temperature Output



Senstronics Storm Series is a unique product providing a lifetime of accuracy for combined pressure/temperature applications used in harsh media requiring stainless steel wetted parts. The 17-4PH stainless steel sensor design allows for a wide range of temperature and provides a rugged design that can withstand high levels of shock and vibration. **Specifications:** • 1/4 NPTF **Note:** Mating harness included with each sensor.



Operating Pressure Range (PSIG)	Operating Temp. Range	Output Voltage	Supply Voltage Range (V)	Digi-Key Part No.	Price Each	Senstronics Part No.
250	-40°C - 125°C	.5 - 4.5	8 - 30	ST00638-ND	38.33	ST00638
500	-40°C - 125°C	.5 - 4.5	8 - 30	ST00223-ND	38.33	ST00223

HUMIREL Sensors

The relative humidity sensors by Humirel are based on capacitive cell technology using a patented solid polymer structure. They are fully interchangeable with no calibration required in standard conditions. Suitable for linear voltage or frequency output circuitry. An NTC thermistor is used for temperature measurement. The RH modules are based on the HS1101LF capacitive humidity sensor and are voltage output devices. The RH/Temperature modules include a NTC thermistor for temperature measurement and are voltage or frequency output.

Features: • High reliability and long term stability • Instantaneous desaturation after long periods in saturation conditions • Fast response times • Patented solid polymer structure

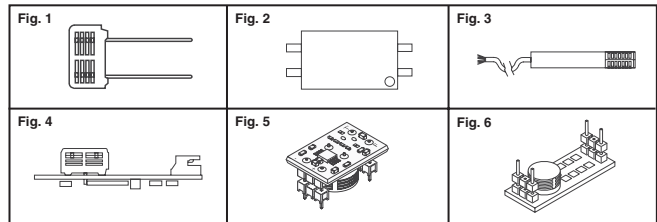

Fig.	Description	Supply Voltage (Typ.)	Nom. Cap. @ 55% RH	Response Time	Nominal Out	RH Measuring Range	Operating Temperature	Digi-Key Part No.	1	10	100	
Sensors - RoHS Compliant												
1	RH Sensor Side Opening	5V	180pF	—	—	1 - 99% RH	-60°C - 140°C	HS1101LF-ND	10.48	9.29	7.86	
2	Temp./RH Sensor SMD Side Opening	5V	180pF	10 Sec.	—	1 - 99% RH	-60°C - 140°C	HTS2030SMD-ND	16.18	14.35	12.14	
Modules												
3	Temp./RH Module Voltage Output	5V	—	—	2.48V @ 55% RH	1 - 99% RH	-30°C - 70°C	HTM2500-ND	57.93	51.73	41.39	
4	Temp./RH Module Freq. Output JST Conn.	5V	—	10 Sec.	8750 Hz @ 55% RH	0 - 99% RH	-30°C - 80°C	HTF3226LF-ND	15.68	14.74	11.80	
5	Temp./RH Module Frequency Output Mini	5V	—	10 Sec.	6600 Hz @ 55% RH	0 - 100% RH	-40°C - 85°C	HTF3000LFPVH-ND	18.35	17.25	13.80	
6	Temp./RH Module Voltage Output Analog	5V	—	10 Sec.	2.48V @ 55% RH	0 - 100% RH	-40°C - 100°C	HTM1735LF-ND	22.23	20.90	16.72	
Demo Kit includes: 1 x HM1500, 1 x HM1510*, and 5 x HS1101									HDEMOKIT-ND	98.37	—	—

* RoHS Compliant * HM1510 - HM1500 with socket at tip to accept HS1101 to test interchangeability

Honeywell Sensing and Control Capacitive Humidity Sensors



HCH-1000 Series humidity sensor is a capacitive polymer sensor designed for relative humidity measurement. **Features:** • Polymer sensing offers enhanced resistance against contamination • Enhanced sensitivity and accuracy, fast response **Operating Temperature Range:** -40°C - 120°C **Operating Humidity Range:** 0% - 100% **HIH-4000 Series** humidity sensors are designed specifically for high volume OEM users. **Features:** • Molded thermoset plastic housing • Near

linear voltage output vs % RH **Operating Temperature Range:** -40°C - 85°C **Operating Humidity Range:** 0% - 100% **HIH-4600-AC Series** relative humidity sensors combine both relative humidity and temperature sensing in a TO-5 housing with a hydrophobic sintered stainless steel filter. **Features:** • Near linear voltage output vs %RH • Chemically resistant • Built-in static protection • TO-5 housing

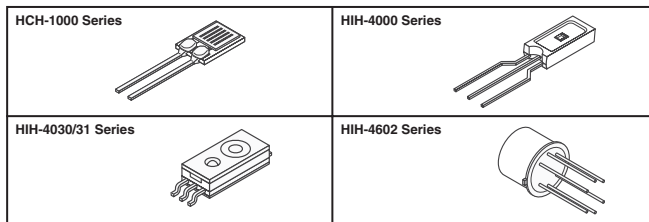

Nom. Cap. (Typ.) @ 55% RH	Sensitivity pF/% RH Min. / Max.	Response Time Sec. (Typ.)	Digi-Key Part No.	1	Price Each	10	100	Honeywell Part No.
HCH-1000 Series								
330pF	0.55/0.65	15	480-2903-ND	3.50	2.44	2.00		HCH-1000-001
			480-2904-ND	3.51	2.50	2.05		HCH-1000-002

Supply Voltage (Vdc) Min. / Max.	Accuracy % RH Min. / Max.	Response Time Sec. (Typ.)	Digi-Key Part No.	1	Price Each	10	100	Tape & Reel Pricing 1,000	Honeywell Part No.
HIH-4000 Series									
4/5.8	-3.5/+3.5	15	480-2905-ND	12.71	10.29	8.63		—	HIH-4000-001
			480-2906-ND	14.54	11.43	9.87		—	HIH-4000-003
HIH-4030 Series									
4/5.8	-3.5/+3.5	5	480-3166-1-ND†	8.17	6.28	5.27	4719.00		HIH-4030-001S
			480-3167-1-ND†	8.49	6.54	5.48	4907.76		HIH-4030-003S
HIH-4031 Series									
4/5.8	-3.5/+3.5	5	480-3168-1-ND†	8.82	6.79	5.69	5096.52		HIH-4031-001S
			480-3169-1-ND†	9.15	7.04	5.90	5285.28		HIH-4031-003S
HIH-4602 Series									
4/5.8	-3.5/+3.5	50	480-3178-ND	34.11	28.43	25.59		—	HIH-4602-C

† Cut Tape ‡ For Tape & Reel part number, change 1-ND to 2-ND.

Digi-Reel® Most SMT cutdown parts are available on a Digi-Reel®. For Digi-Reel part number, change 1-ND to 6-ND or CT-ND to DKR-ND. See Digi-Key® Services on page 2 for additional information.

Free shipping on orders over £50! All prices are in British pound sterling and include duties.

2262 (UK091) uk.digikey.com — FREEPHONE: 0-800-587-0991 • 0-800-904-7786 — FREEFAX: 0-800-587-0992 • 0-800-904-7783

GE Sensing ChipCap Humidity and Temperature Sensors



Features: • Simultaneous relative humidity and temperature outputs • Precision accuracy $\pm 2\%$ RH, $\pm 0.6^\circ\text{C}$ • Factory selectable analog or digital outputs • Supply voltage: 3.0V – 5.5V • 14-SOP package

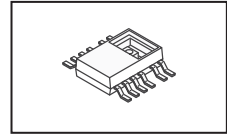

Output Type	Measuring Range (% RH)	Digi-Key Part No.	Price Each			GE Sensing Part No.
			1	10	100	
0 – 1 VDC Linear 0.5 – 4.5 VDC Ratiometric Digital	0 – 100	CHIPCAP-L-ND	16.51	14.45	11.21	CHIPCAP-L
		CHIPCAP-R-ND	16.51	14.45	11.21	CHIPCAP-R
		CHIPCAP-D-ND	14.48	12.67	9.83	CHIPCAP-D

TDK CHS Series Humidity Sensors



TDK's CHS Series humidity sensors are compact and extremely simple to apply. Because they contain the necessary circuitry, there is no need to provide additional control circuitry or perform time-consuming calibration. With simple connection to a power supply, they will output DC at 100% relative humidity. This makes it possible to read RH directly with a voltmeter.

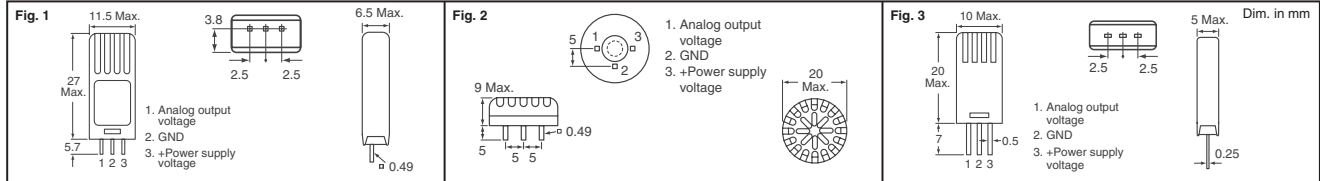

Fig.	Supply Voltage (VDC)	Measuring Range (% RH)	Nominal Accuracy RH	Digi-Key Part No.	Price Each			TDK Part No.
					1	10	100	
1	5	5 – 95	$\pm 5\%$	445-2577-ND	37.03	33.34	29.63	CHS-UGS
		5 – 95	$\pm 3\%$	445-2578-ND	54.01	46.30	40.13	CHS-UPS
2	5	5 – 95	$\pm 3\%$	445-2579-ND	54.01	46.30	40.13	CHS-UPR
		5 – 90	$\pm 5\%$	445-2575-ND	24.69	22.23	19.76	CHS-GSS
3	5	20 – 85	$\pm 5\%$	445-2576-ND	17.29	15.56	13.83	CHS-MSS

VISHAY BCcomponents Capacitive Humidity Sensor



The capacitive atmospheric humidity sensor consists of a non-conductive foil, which is covered on both sides with a layer of gold. The dielectric constant of the foil changes as a function of the relative humidity of the ambient atmosphere, and accordingly, the capacitance value of the sensor is a measure for relative humidity.

Humidity Range (RH)	Capacitance (pF)	Sensitivity Between 12-75% RH (pF/%RH)	Frequency (kHz)	Max. AC / DC Voltage (V)	Storage Humidity Range (RH)	Ambient Temperature Range ($^\circ\text{C}$)		Digi-Key Part No.	Price Each			Vishay Part No.
						Operating	Storage		1	10	100	
10 – 90%	122 $\pm 15\%$	0.4 ± 0.05	1 – 1000	15	0 – 100%	0 – 85	-25 – 85	BC2325-ND	14.49	13.03	10.26	2381 691 90001

* Capacitance at 25 $^\circ\text{C}$; 43% RH; 100kHz

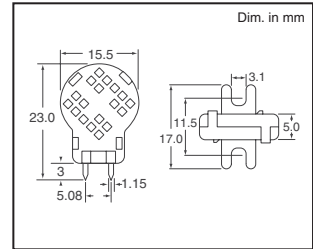

WORLD MAGNETICS Ultra Sensitive Pressure Switches

PSF109S Series:

Vacuum switch with Hysteresis (deadband) for motor control. Field-adjustable vacuum set point. Switch-type is SPDT normally open, normally closed. For use with AMP 2-520182-2 or equivalent.

In. H ₂ O	Tolerance	Operating Current/Voltage	Digi-Key Part No.	Price Each			World Magnetics Part No.
				1	10	100	
3 – 8	$\pm 20\%$	3A 125/250VAC	384-1020-ND	16.23	15.43	11.53	PSF109S-NPT-3-8

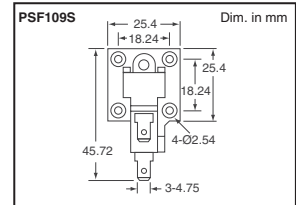

OMRON Capacitive Proximity Sensors



Capacitive sensors operate similar to Inductive sensors except that a plate is used instead of a coil in the sensor's head. This plate develops a capacitive field between the sensor and ground. When an object comes within sensing distance of the sensor, the capacitive field changes which gets detected by the sensor and turns on the output. Perfect for detecting both metallic and non-metallic objects such as glass, wood, water, oils and plastics. Also works well for detecting liquids and solids in containers.

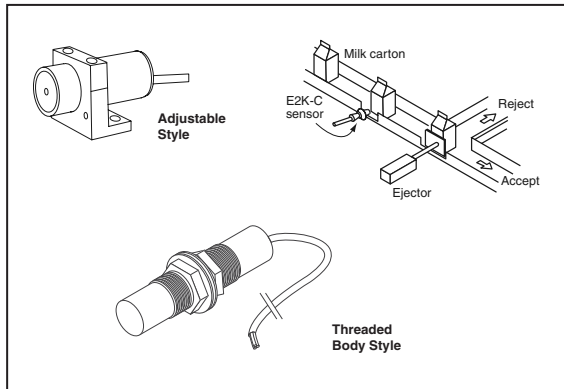

Sensing Distance	Description	Output Type	Digi-Key Part No.	Price Each	Omron Part No.
3 – 25mm	Amplified Sensor, Adjustable, NO, 10-40VDC	NPN	Z1071-ND	101.20	E2K-C25ME1
3 – 25mm	Amplified Sensor, Adjustable, NC, 10-40VDC	NPN	Z1072-ND	101.20	E2K-C25ME2
3 – 25mm	Amplified Sensor, Adjustable, NC, 90-250VAC	SCR	Z1073-ND	130.67	E2K-C25MY1
3 – 25mm	Amplified Sensor, Adjustable, NC, 90-250VAC	SCR	Z1074-ND	101.20	E2K-C25MY2
Mounting Bracket for E2K-C Sensors.....			Z1659-ND	4.17	Y92E-A34
0 – 4mm	M12, 3 Wire Sensor, THD Body, NO, 10-30VDC	PNP	Z2356-ND	81.12	E2K-X4MF1
0 – 8mm	M18, 3 Wire Sensor, THD Body, NO, 30VDC	PNP	Z2426-ND	77.30	E2K-X8MF1
0 – 15mm	M30, 3 Wire Sensor, THD Body, NO, 10-30VDC	PNP	Z2427-ND	81.92	E2K-X15MF1
0 – 4mm	M12, 3 Wire Sensor, THD Body, NO, 10-30VDC	NPN	Z2423-ND	81.12	E2K-X4ME1
0 – 8mm	M18, 3 Wire Sensor, THD Body, NO, 10-30VDC	NPN	Z2424-ND	77.30	E2K-X8ME1
0 – 15mm	M30, 3 Wire Sensor, THD Body, NO, 10-30VDC	NPN	Z2425-ND	81.92	E2K-X15ME1
0 – 8mm	M18, 2 Wire Sensor, THD Body, NO, 90-250VAC	SCR	Z2421-ND	97.98	E2K-X8MY1
0 – 15mm	M30, 2 Wire Sensor, THD Body, NO, 90-250VAC	SCR	Z2422-ND	106.02	E2K-X15MY1

Free shipping on orders over £50! All prices are in British pound sterling and include duties.

uk.digikey.com — FREEPHONE: 0-800-587-0991 • 0-800-904-7786 — FREEFAX: 0-800-587-0992 • 0-800-904-7783

(UK091) 2263

N