

Snap-action contact mechanism. Snap-in mount (W01) with solder lug terminals and silver contacts; PCB mount (G03) with straight PC terminals and gold contacts.

Features:

• **Electrical Capacity:** • **Power Level (code W):** 5A at 125/250VAC or 5A at 30VDC • **Logic Level (code G):** 0.4VA maximum at 28V AC/DC maximum • **Dielectric Strength:** 1,000VAC minimum between contacts • **Mechanical Life:** 1,000,000 operations minimum (momentary); 200,000 operations minimum (alternate action) • **Electrical Life:** 10,000 operations minimum (silver); 200,000 operations minimum (gold) • **Total Travel:** .091" • **Operation Force:** 160 grams for single pole, 260 grams for double pole • **Contact Timing:** Break before make • **Operating Temperature:** -25°C - 50°C
UB Models: **UL recognized and CSA certified:** LED Rating: Red 1.85V at 20mA, Amber 2.0V at 20mA, Green 2.1V at 20mA.

Dimensions in (mm) Inch

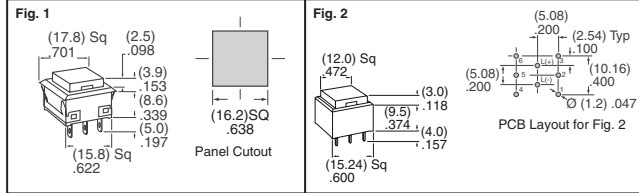
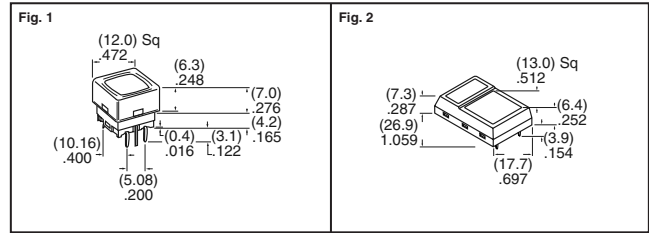

Fig.	Circuit	Switching Function	LED	Cap Desc. Lens / Diffuser	Digi-Key Part No.	Price Each	1	25	100	NKK Part No.	
Square Snap-in Mount, Single Element LED (UB Series) — 5A											
1	SPDT	On-Mom	Red	Red / Red	360-2102-ND	7.19	4.89	4.50		UB15KKW015C-CC-RO	
	SPDT	On-Mom	Amber	Amber / Amber	360-2103-ND	7.19	4.89	4.50		UB15KKW015D-DD-RO	
	SPDT	On-Mom	Green	Green / Green	360-2104-ND	7.19	4.89	4.50		UB15KKW015F-FF-RO	
	DPDT	On-Mom	Red	Red / Red	360-2105-ND	8.55	6.19	5.51		UB25KKW015C-CC-RO	
	DPDT	On-Mom	Amber	Amber / Amber	360-2106-ND	8.55	6.19	5.51		UB25KKW015D-DD-RO	
	DPDT	On-Mom	Green	Green / Green	360-1533-ND	9.31	6.75	6.01		UB25KKW015F-FF-RO	
2	DPDT	On-Mom	Green	Green / Green	360-2107-ND	8.55	6.19	5.51		UB25KKW015F-FF-RO	
	Square PCB Mount, Single Element LED (UB Series) — 4VA										
	SPDT	On-Mom	Red	Red / Red	360-1945-ND	6.96	4.78	4.35		UB15SKG035C-CC-RO	
	SPDT	On-Mom	Amber	Amber / Amber	360-1946-ND	6.96	4.78	4.35		UB15SKG035D-DD-RO	
	SPDT	On-Mom	Green	Green / Green	360-1947-ND	6.96	4.78	4.35		UB15SKG035F-FF-RO	
	DPDT	On-Mom	Red	Red / Red	360-1948-ND	8.68	6.29	5.59		UB25SKG035C-CC-RO	
2	DPDT	On-Mom	Amber	Amber / Amber	360-1544-ND	8.33	6.04	5.37		UB25SKG035D-DD-RO	
	DPDT	On-Mom	Amber	Amber / Amber	360-1949-ND	8.68	6.29	5.59		UB25SKG035D-DD-RO	
	DPDT	On-Mom	Green	Green / Green	360-1950-ND	8.68	6.29	5.59		UB25SKG035F-FF-RO	

RoHS Compliant



JB Series - Illuminated, Low Profile Momentary Switches:

Bright full face LED illumination for extremely long life. Sealed for automated soldering processes. Higher operating force provides more pronounced operating feel. All lenses come standard with diffused colored lens unless noted as clear. Terminal spacing conforming to .100" PCB grid. Straight, molded-in PC terminals. Single pole, single throw, variety of cap colors. Red, yellow or green LEDs.

Electrical Capacity: 50mA at 24VDC, maximum **Dielectric Strength:** 250VAC minimum **Mechanical Life:** 5,000,000 operations minimum **Electrical Life:** 5,000,000 operations minimum **Operating Temperature:** -25°C - 70°C **Total Travel:** .010"

JF Series - Illuminated, Ultra-Thin Momentary Switches:

JF Series are washable tactile switches with crisp tactile feedback. Terminal spacing conforming to .100" PCB grid. Single pole, single throw, variety of cap colors. Red, yellow or green LEDs.

Electrical Capacity: 50mA at 24VDC maximum **Dielectric Strength:** 250VAC minimum **Mechanical Life:** 500,000 operations minimum **Electrical Life:** 500,000 operations minimum **Operating Temperature:** -25°C - 70°C **Total Travel:** .016"

Fig.	Circuit	LED Color	Cap Description Lens	Diffuser	Digi-Key Part No.	Price Each	1	25	100	NKK Part No.
JB Series Illuminated Low Profile Switches										
1	SPST	Red	Clear	White	360-1260-ND	3.35	2.10	1.92		JB15LPC-JB
	SPST	Red	Clear	Red	360-1261-ND	3.35	2.10	1.92		JB15LPC-JC
	SPST	Yellow	Clear	White	360-1262-ND	3.35	2.10	1.92		JB15LPE-JB
	SPST	Yellow	Clear	Yellow	360-1263-ND	3.35	2.10	1.92		JB15LPE-JE
	SPST	Green	Clear	White	360-1264-ND	3.35	2.10	1.92		JB15LPE-JB
	SPST	Green	Clear	Green	360-1265-ND	3.35	2.10	1.92		JB15LPE-JF
JF Series Illuminated Ultra Thin Switches										
2	SPST	Red	—	—	360-1266-ND	5.05	3.50	3.09		JF15AP1CC
	SPST	Yellow	—	—	360-1267-ND	5.80	4.11	3.63		JF15AP1EE
	SPST	Green	—	—	360-1268-ND	5.25	3.57	3.22		JF15AP1FF

Illuminated Low Profile Pushbutton Switches with Alternating Legend

The UB2's options feature super bright bi-color LEDs with alternating legends by color, all in one switch. These options offer innovative design engineers an exceptional choice to replace outdated, split legend caps. Super bright, red/green, bi-color LED switch selections can be specified with alternating ON/OFF, START/STOP, or OPEN/CLOSE legend configurations. The glossy polycarbonate cap features a single filter with a dual legend under the clear lens.

When actuated, the green or red LED brilliantly highlights the alternating legends, clearly indicating the desired circuit status. Legend text is black. **Electrical Capacity:** • **Power Level (Silver):** 5A @ 125/250VAC or 30VDC • **Logic Level (Gold):** 0.4VA maximum @ 28V AC/DC maximum **Mechanical Life:** 1,000,000 Operations minimum (momentary); 200,000 Operations minimum (alternate action) **Operating Temperature Range:** -25°C - 50°C

Circuit	Mounting Type	Switching Function	Contact Material	Alternating Legend	Digi-Key Part No.	Price Each	1	25	100	NKK Part No.
SPDT	PCB	On-Mom	Gold	ON/OFF	360-2227-ND	15.28	11.85	10.70		UB215SKG036CF-4J01
SPDT	PCB	On-On	Gold	ON/OFF	360-2223-ND	15.85	12.29	11.10		UB216SKG036CF-4J01
DPDT	PCB	On-Mom	Gold	ON/OFF	360-2229-ND	17.24	13.36	12.07		UB225SKG036CF-4J01
DPDT	PCB	On-On	Gold	ON/OFF	360-2225-ND	18.04	13.53	12.63		UB226SKG036CF-4J01
SPDT	Snap-In	On-Mom	Silver	ON/OFF	360-2226-ND	14.96	11.60	10.47		UB215KKW016CF-4J01
SPDT	Snap-In	On-On	Silver	ON/OFF	360-2222-ND	15.53	12.03	10.87		UB216KKW016CF-4J01
DPDT	Snap-In	On-Mom	Silver	ON/OFF	360-2228-ND	16.60	12.86	11.63		UB225KKW016CF-4J01
DPDT	Snap-In	On-On	Silver	ON/OFF	360-2224-ND	17.40	13.49	12.19		UB226KKW016CF-4J01
SPDT	PCB	On-Mom	Gold	START/STOP	360-2235-ND	15.28	11.85	10.70		UB215SKG036CF-4J02
SPDT	PCB	On-On	Gold	START/STOP	360-2231-ND	15.85	12.29	11.10		UB216SKG036CF-4J02
DPDT	PCB	On-Mom	Gold	START/STOP	360-2237-ND	17.24	13.36	12.07		UB225SKG036CF-4J02
DPDT	PCB	On-On	Gold	START/STOP	360-2233-ND	18.04	13.53	12.63		UB226SKG036CF-4J02
SPDT	Snap-In	On-Mom	Silver	START/STOP	360-2234-ND	14.96	11.60	10.47		UB215KKW016CF-4J02
SPDT	Snap-In	On-On	Silver	START/STOP	360-2230-ND	15.53	12.03	10.87		UB216KKW016CF-4J02
DPDT	Snap-In	On-Mom	Silver	START/STOP	360-2236-ND	16.60	12.86	11.63		UB225KKW016CF-4J02
DPDT	Snap-In	On-On	Silver	START/STOP	360-2232-ND	17.40	13.49	12.19		UB226KKW016CF-4J02
SPDT	PCB	On-Mom	Gold	OPEN/CLOSE	360-2243-ND	15.28	11.85	10.70		UB215SKG036CF-4J04
SPDT	PCB	On-On	Gold	OPEN/CLOSE	360-2239-ND	15.85	12.29	11.10		UB216SKG036CF-4J04
DPDT	PCB	On-Mom	Gold	OPEN/CLOSE	360-2245-ND	17.24	13.36	12.07		UB225SKG036CF-4J04
DPDT	PCB	On-On	Gold	OPEN/CLOSE	360-2241-ND	18.04	13.53	12.63		UB226SKG036CF-4J04
SPDT	Snap-In	On-Mom	Silver	OPEN/CLOSE	360-2242-ND	14.96	11.60	10.47		UB215KKW016CF-4J04
SPDT	Snap-In	On-On	Silver	OPEN/CLOSE	360-2238-ND	15.53	12.03	10.87		UB216KKW016CF-4J04
DPDT	Snap-In	On-Mom	Silver	OPEN/CLOSE	360-2244-ND	16.60	12.86	11.63		UB225KKW016CF-4J04
DPDT	Snap-In	On-On	Silver	OPEN/CLOSE	360-2240-ND	17.40	13.49	12.19		UB226KKW016CF-4J04

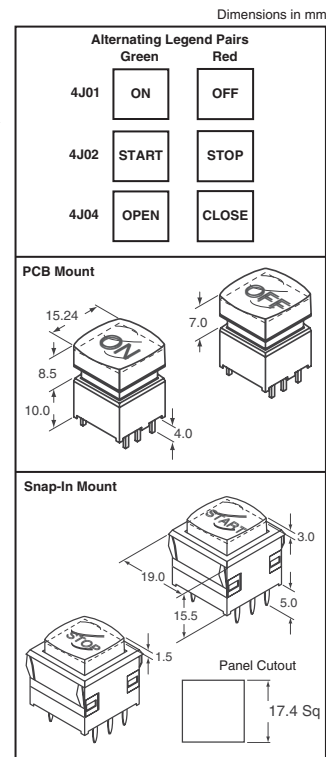

KB Series Miniature Bushing Mount

The KB pushbuttons are SPDT or DPDT snap acting contact mechanism, providing long electrical life and pronounced sensitivity. Comes complete with nut. 12mm diameter makes this switch ideal for stacking into a panel using minimal

room. LED illumination for long service life. **Features:** • **Electrical Capacity:** 1A @ 125/250VAC or 30VDC for silver contacts • **Dielectric Strength:** 1,500VAC minimum between contacts and case • **Mechanical Life:** 100,000 operations minimum • **Electrical Life:** 50,000 operations minimum (silver) • **Total Travel:** .118" • **Operating Temperature:** -25°C - 50°C • **UL recognized and CSA certified @ 1A rating**

Dimensions in (mm) Inch

Fig.	Circuit	Switching Function	Color	Digi-Key Part No.	1	25	100	NKK Part No.
KB Series Square Bezel Switches								
1	SPDT	On-Mom	Red	360-1990-ND	7.63	5.41	4.98	KB15SKW01-5C-JC-RO
		On-Mom	Amber	360-1991-ND	7.63	5.41	4.98	KB15SKW01-5D-JD-RO
		On-Mom	Green	360-1992-ND	7.63	5.41	4.98	KB15SKW01-5F-JF-RO
		On-On	Red	360-1999-ND	8.18	5.80	5.34	KB16SKW01-5C-JC-RO
		On-On	Amber	360-2000-ND	8.18	5.80	5.34	KB16SKW01-5D-JD-RO
		On-On	Green	360-2001-ND	8.18	5.80	5.34	KB16SKW01-5F-JF-RO
	DPDT	On-Mom	Red	360-1613-ND	10.05	7.28	6.48	KB25SKW01-5C-JC
		On-Mom	Red	360-2008-ND	9.21	6.68	5.94	KB25SKW01-5C-JC-RO
		On-Mom	Amber	360-1614-ND	8.62	6.25	5.56	KB25SKW01-5D-JD
		On-Mom	Amber	360-2009-ND	9.21	6.68	5.94	KB25SKW01-5D-JD-RO
		On-Mom	Green	360-2010-ND	9.21	6.68	5.94	KB25SKW01-5F-JF-RO
		On-On	Red	360-2017-ND	9.71	7.03	6.26	KB26SKW01-5C-JC-RO
2	SPDT	On-Mom	Red	360-1984-ND	7.63	5.41	4.98	KB15CKW01-5C-JC-RO
		On-Mom	Amber	360-1985-ND	7.63	5.41	4.98	KB15CKW01-5D-JD-RO
		On-Mom	Green	360-1986-ND	7.63	5.41	4.98	KB15CKW01-5F-JF-RO
		On-On	Red	360-1993-ND	8.18	5.80	5.34	KB16CKW01-5C-JC-RO
		On-On	Amber	360-1994-ND	8.18	5.80	5.34	KB16CKW01-5D-JD-RO
		On-On	Green	360-1995-ND	8.18	5.80	5.34	KB16CKW01-5F-JF-RO
	DPDT	On-Mom	Red	360-2002-ND	9.21	6.68	5.94	KB25CKW01-5C-JC-RO
		On-Mom	Amber	360-1626-ND	8.62	6.25	5.56	KB25CKW01-5D-JD
		On-Mom	Amber	360-2003-ND	9.21	6.68	5.94	KB25CKW01-5D-JD-RO
		On-Mom	Green	360-2004-ND	9.21	6.68	5.94	KB25CKW01-5F-JF-RO
		On-On	Red	360-2011-ND	9.71	7.03	6.26	KB26CKW01-5C-JC-RO
		On-On	Amber	360-2012-ND	10.05	7.28	6.48	KB26CKW01-5D-JD-RO
3	SPDT	On-Mom	Red	360-1987-ND	7.63	5.41	4.98	KB15RKW01-5C-JC-RO
		On-Mom	Amber	360-1988-ND	7.63	5.41	4.98	KB15RKW01-5D-JD-RO
		On-Mom	Green	360-1989-ND	7.63	5.41	4.98	KB15RKW01-5F-JF-RO
		On-On	Red	360-1996-ND	8.18	5.80	5.34	KB16RKW01-5C-JC-RO
		On-On	Amber	360-1635-ND	7.67	5.44	5.00	KB16RKW01-5D-JD
		On-On	Green	360-1997-ND	8.18	5.80	5.34	KB16RKW01-5D-JD-RO
	DPDT	On-Mom	Red	360-2005-ND	9.21	6.68	5.94	KB25RKW01-5C-JC-RO
		On-Mom	Amber	360-1638-ND	10.05	7.28	6.48	KB25RKW01-5D-JD
		On-Mom	Amber	360-2006-ND	9.21	6.68	5.94	KB25RKW01-5D-JD-RO
		On-Mom	Green	360-2007-ND	9.21	6.68	5.94	KB25RKW01-5F-JF-RO
		On-On	Red	360-2014-ND	9.71	7.03	6.26	KB26RKW01-5C-JC-RO
		On-On	Amber	360-2015-ND	9.71	7.03	6.26	KB26RKW01-5D-JD-RO
4				KB Accessories — RoHS Compliant				
	Socket Wrench for Panel Mount KB Series			360-1000-ND	1.94	1.19	1.07	AT108
	Protective Guard for Square/Round KB Series			360-1004-ND	1.70	1.02	.89	AT494
	Protective Guard for Rectangular KB Series			360-1006-ND	1.82	1.09	.96	AT4024

◆ RoHS Compliant

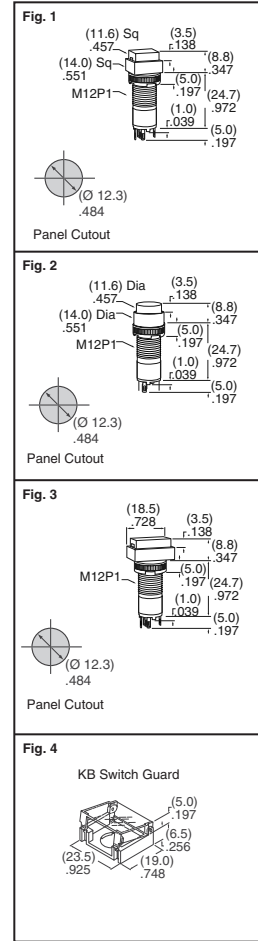

LB Series Standard Size Snap-in Mount

The pushbutton switch is designed with a single-break, snap-action contact mechanism. The combined butterfly formation and spring action of the movable

contact create the quick-make, quick-break characteristic which limits arcing and prolongs electrical life. The switch is offered with momentary or alternate action circuits in single or double pole configurations. **Features:** • **Electrical Capacity:** 3A @ 125/250VAC or 30VDC for silver contacts • **Dielectric Strength:**

1,500 VAC minimum between contacts and case • **Mechanical Life:** 1,000,000 operations minimum for momentary; 200,000 operations minimum for maintained • **Electrical Life:** 100,000 operations minimum • **Total Travel:** .118" • **Operating Temperature:** -25°C - 50°C • **UL recognized and CSA certified @ 3A rating**

Fig.	Circuit	Switching Function	Color	Digi-Key Part No.	1	25	100	NKK Part No.
LB Series Square Bezel Switches								
1	SPDT	On-Mom	Red	360-2026-ND	9.93	7.23	6.55	LB15SKW01-5C-JC-RO
		On-Mom	Amber	360-2027-ND	9.93	7.23	6.55	LB15SKW01-5D-JD-RO
		On-Mom	Green	360-2028-ND	9.93	7.23	6.55	LB15SKW01-5F-JF-RO
		On-On	Red	360-1646-ND	10.64	7.74	7.02	LB16SKW01-5C-JC
		On-On	Red	360-2035-ND	11.02	8.02	7.27	LB16SKW01-5C-JC-RO
		On-On	Amber	360-1647-ND	10.64	7.74	7.02	LB16SKW01-5D-JD
	DPDT	On-Mom	Red	360-2044-ND	11.77	8.57	7.76	LB25SKW01-5C-JC-RO
		On-Mom	Amber	360-1650-ND	11.34	8.25	7.48	LB25SKW01-5D-JD
		On-Mom	Amber	360-2045-ND	11.77	8.57	7.76	LB25SKW01-5D-JD-RO
		On-Mom	Green	360-1651-ND	11.34	8.25	7.48	LB25SKW01-5F-JF
		On-Mom	Green	360-2046-ND	11.77	8.57	7.76	LB25SKW01-5F-JF-RO
		On-On	Red	360-2053-ND	12.29	9.07	8.34	LB26SKW01-5C-JC-RO
2	SPDT	On-On	Amber	360-2054-ND	12.29	9.07	8.34	LB26SKW01-5D-JD-RO
		On-On	Green	360-2055-ND	12.29	9.07	8.34	LB26SKW01-5F-JF-RO
		On-Mom	Red	360-2020-ND	9.93	7.23	6.55	LB15CKW01-5C-JC-RO
		On-Mom	Amber	360-2021-ND	9.93	7.23	6.55	LB15CKW01-5D-JD-RO
		On-Mom	Green	360-2022-ND	9.93	7.23	6.55	LB15CKW01-5F-JF-RO
		On-On	Red	360-1658-ND	10.64	7.74	7.02	LB16CKW01-5C-JC
	DPDT	On-On	Red	360-2029-ND	11.02	8.02	7.27	LB16CKW01-5C-JC-RO
		On-On	Amber	360-1659-ND	12.03	8.75	7.93	LB16CKW01-5D-JD

◆ RoHS Compliant

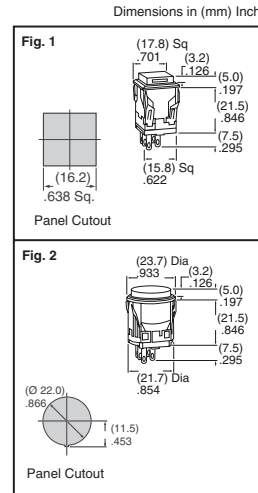

(Continued)

Free shipping on orders over £50! All prices are in British pound sterling and include duties.

uk.digikey.com — FREEPHONE: 0-800-587-0991 • 0-800-904-7786 — FREEFAX: 0-800-587-0992 • 0-800-904-7783

(UK091) 2045

Dimensions in (mm) Inch

Fig.	Circuit	Switching Function	Color	Digi-Key Part No.	1	25	100	NKK Part No.
LB Series Round Bezel Switches — RoHS Compliant								
2	DPDT	On-On	Amber	360-2030-ND	11.02	8.02	7.27	LB16CKW01-5D-JD-RO
		On-On	Green	360-2031-ND	11.02	8.02	7.27	LB16CKW01-5F-JF-RO
		On-Mom	Red	360-2038-ND	11.77	8.57	7.76	LB25CKW01-5C-JC-RO
		On-Mom	Amber	360-2039-ND	11.77	8.57	7.76	LB25CKW01-5D-JD-RO
		On-Mom	Green	360-2040-ND	11.77	8.57	7.76	LB25CKW01-5F-JF-RO
		On-On	Red	360-2047-ND	12.29	9.07	8.34	LB26CKW01-5C-JC-RO
		On-On	Amber	360-2048-ND	12.29	9.07	8.34	LB26CKW01-5D-JD-RO
		On-On	Green	360-2049-ND	12.29	9.07	8.34	LB26CKW01-5F-JF-RO
LB Series Rectangular Bezel Switches								
3	SPDT	On-Mom	Red	360-2023-ND	9.93	7.23	6.55	LB15RKW01-5C-JC-RO
		On-Mom	Amber	360-2024-ND	9.93	7.23	6.55	LB15RKW01-5D-JD-RO
		On-Mom	Green	360-2025-ND	9.93	7.23	6.55	LB15RKW01-5F-JF-RO
		On-On	Red	360-2032-ND	11.02	8.02	7.27	LB16RKW01-5C-JC-RO
		On-On	Amber	360-2033-ND	11.02	8.02	7.27	LB16RKW01-5D-JD-RO
		On-On	Green	360-2034-ND	11.02	8.02	7.27	LB16RKW01-5F-JF-RO
	DPDT	On-Mom	Red	360-2041-ND	11.77	8.57	7.76	LB25RKW01-5C-JC-RO
		On-Mom	Amber	360-1674-ND	11.34	8.25	7.48	LB25RKW01-5D-JD-RO
		On-Mom	Amber	360-2042-ND	11.77	8.57	7.76	LB25RKW01-5D-JD-RO
		On-Mom	Green	360-1675-ND	11.34	8.25	7.48	LB25RKW01-5F-JF-RO
		On-Mom	Green	360-2043-ND	11.77	8.57	7.76	LB25RKW01-5F-JF-RO
		On-On	Red	360-2050-ND	12.29	9.07	8.34	LB26RKW01-5C-JC-RO
		On-On	Amber	360-2051-ND	12.29	9.07	8.34	LB26RKW01-5D-JD-RO
		On-On	Green	360-2052-ND	12.29	9.07	8.34	LB26RKW01-5F-JF-RO
LB Accessories — RoHS Compliant								
4	Protective Guard for Square LB Series			360-1005-ND	2.16	1.33	1.15	AT499
	Protective Guard for Rectangular LB Series			360-1007-ND	2.16	1.33	1.15	AT4057

Fig. 3

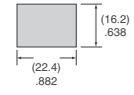
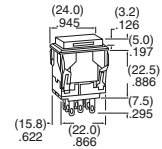

Panel Cutout

Fig. 4

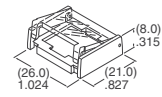

◆ RoHS Compliant

Electrical Characteristics:

• Contact Rating: Maximum Current: 100mA; Maximum Voltage: 24V • Contact Resistance: 100mΩ maximum • Insulation Resistance: 100MΩ minimum (DC500V)

General Characteristics:

• Switch Type: Normally Open • Operating Temperature Range: -55°C – 125°C • Dielectric Strength: 250VAC

Mechanical Characteristics:

• Cycle Life, Loaded: 10,000 actuations

Type	Digi-Key Part No.	Cut Tape Price Each			Digi-Key Part No.	Tape and Reel Pricing		
		1	10	100		500	1,000	5,000
J-Hook	7914J-000ECT-ND	.69	.61	.51	7914J-000ETR-ND	196.02	343.40	294.03/M
Gull Wing	7914G-000ECT-ND	.69	.61	.51	7914G-000ETR-ND	196.02	343.40	294.03/M

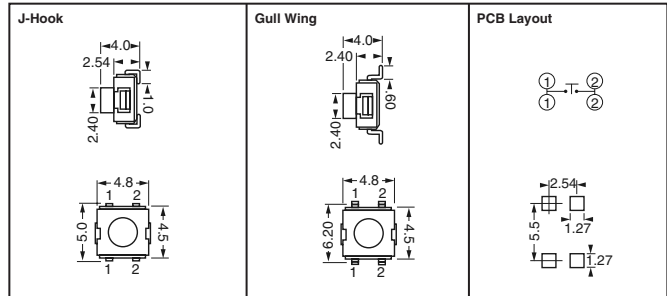

Sealed Selector Switches

Electrical Characteristics:

• Contact Rating: Maximum Current: 100mA Maximum Voltage: 24V • Contact Timing: Non-Shorting • Contact Resistance: 2Ω maximum • Insulation Resistance: 100MΩ minimum (DC500V) • Dielectric Strength: 250VAC

General Characteristics:

• Switch Type: SPDT • Operating Temperature Range: -55°C – 125°C

Fig.	Size (mm)	Life	Digi-Key Part No.	Cut Tape Price Each			Digi-Key Part No.	Tape & Reel Pricing	
				1	10	100		500	1,000
1	3	50	7813J-051ECT-ND	1.52	1.35	1.14	7813J-051ETR-ND	—	762.30
			7813J-023ECT-ND	1.68	1.49	1.25	7813J-023ETR-ND	—	838.53
2	4	50	7814G-051ECT-ND	1.52	1.35	1.14	7814G-051ETR-ND	435.60	762.30
			7814G-023ECT-ND	1.68	1.49	1.25	7814G-023ETR-ND	479.16	838.53
3	4	50	7814J-051ECT-ND	1.52	1.35	1.14	7814J-051ETR-ND	435.60	762.30
			7814J-023ECT-ND	1.68	1.49	1.25	7814J-023ETR-ND	479.16	838.53

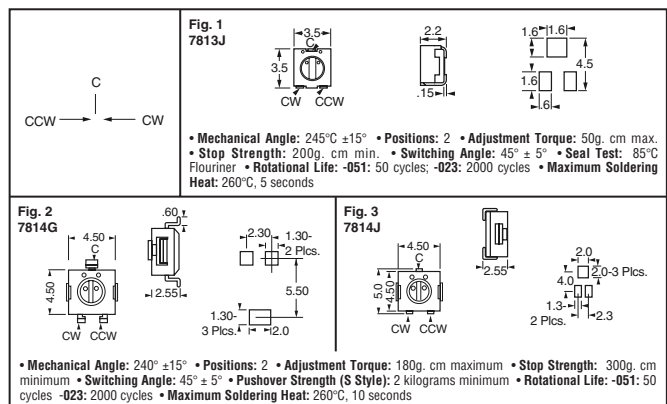

Digi-Reel® Most SMT cutdown parts are available on a Digi-Reel®. For Digi-Reel part number, change 1-ND to 6-ND or CT-ND to DKR-ND. See Digi-Key® Services on page 2 for additional information.

Free shipping on orders over £50! All prices are in British pound sterling and include duties.
2046 (UK091) uk.digikey.com — FREEPHONE: 0-800-587-0991 • 0-800-904-7786 — FREEFAX: 0-800-587-0992 • 0-800-904-7783