

**TIP Telecom Duty Fuses (Telecom Interface Protector)**

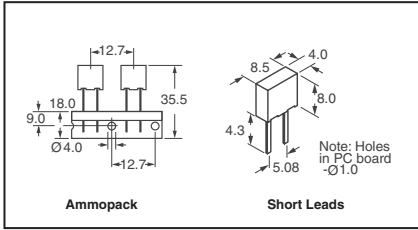

**Electrical Characteristics:**

| Rated Current | Pre-arcing Rating |            |
|---------------|-------------------|------------|
|               | 100%              | 300%       |
| 350mA - 1.50A | 2 hr. minimum     | 300ms...5s |

**Approvals:** cULus Recognized: File No. E67006. Complies to EIA-15-96B; Telcordia GR-1089

**Features:**

- For UL60950/1950 3rd Edition applications • Highly defined cutoff times
- Flame resistant encapsulated casing • Low internal resistance • Irreversible physical separation • Stable characteristics under varying temperatures

**Maximum Fault Currents:** ≤50A at 125VAC; ≤35A at 125VDC

**Material:**

- Base and Cap: Brown thermoplastic (polyamide PA 6.6), UL 94-V0; • Round Pins: Copper alloy, tin-plated

| Amp Rating            | Voltage Rating | Digi-Key Part No. | Price Each | Tape & Ammo-Pk Qty. | Pricing† |
|-----------------------|----------------|-------------------|------------|---------------------|----------|
| <b>TIP 385 Series</b> |                |                   |            |                     |          |
| .350                  | 125            | WK4560BK-ND       | .43 .40    | 1,400               | 180.02/M |
| 1.00                  | 125            | WK4563BK-ND       | .43 .40    | 1,400               | 180.02/M |
| 1.25                  | 125            | WK4564BK-ND       | .43 .40    | 1,400               | 180.02/M |
| 1.50                  | 125            | WK4565BK-ND       | .43 .40    | 1,400               | 180.02/M |

† For Tape and Ammo Pack number, change BK-ND to TB-ND.

**Picofuse Fast Acting 125V 275 Series**

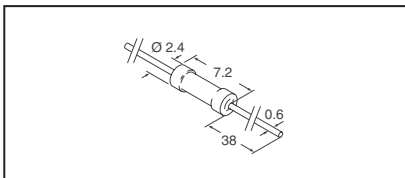

**Applicable Standards:** • UL 248-14 • CSA C22.2 No. 248.14

**Approvals:** • UL Listed: File No. E 67006 (125mA - 7A) • cUL Listed: File No. E 67006 (125mA - 7A) • UL Recognized: File No. E 67006 (10A) • CSA Certified: File No. 51378 (10A)

**Features:** • Subminiature • Axial Leads

**Materials:** • Body: Ceramic tube, Heat Shrink tube • Plug-on Caps: Copper alloy, tin plated

**Operating Temperature:** -25°C - 70°C (consider de-rating)

**Electrical Characteristics:**



| Rated Current  | Pre-arcing Rating |                      |
|----------------|-------------------|----------------------|
|                | 200%              | 200% Wickmann Tested |
| 125mA - 10.00A | <60s              | <5s                  |

| Amp Rating (A)    | Voltage Rating | Digi-Key Part No. | Cut Tape Price Each | Tape & Reel Pricing† |
|-------------------|----------------|-------------------|---------------------|----------------------|
| <b>275 Series</b> |                |                   |                     |                      |
| 4.00              | 125            | WK1092CT-ND       | .26 .25             | 121.97/M             |
| 10.0              | 125            | WK1095CT-ND       | .26 .25             | —                    |

† For Tape and Reel part number, change CT-ND to TR-ND.

**TE5 Fuseholder**

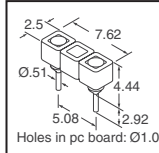

**Material:**

- Black thermoplastic UL 94-V0
- Terminals: Brass, tin-plated for soldering

**Rated Values:**

250V; 6.3A; UL Recognized

|           |           |         |           |
|-----------|-----------|---------|-----------|
| WK0009-ND | .....93/1 | 8.58/10 | 64.36/100 |
|-----------|-----------|---------|-----------|

**TE5 Sub-Miniature Fuses - UL 248-14**

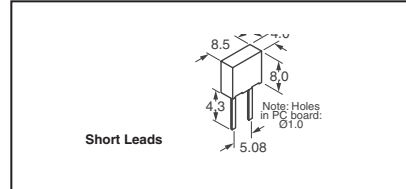

**Approvals (395 and 396 Series):**

cUL Listed, UL Listed for .050A - 6.30A. MITI approved for 1.00A - 5.00A

**Features:**

- Fast-acting and time-lag
- Material: Brown thermoplastic UL 94-V0
- Round Pins: Copper alloy, tin-plated
- Soldering Heat Resistance: 260°C, 10 seconds (IEC 60068-2-20)
- Plug-in holders available

**Electrical Characteristics:**

| Series | Rated Current | Pre-arcing Rating |           |
|--------|---------------|-------------------|-----------|
|        |               | 100%              | 200%      |
| 395    | 50mA - 6.3A   | > 4 hr.           | < 5 sec.  |
| 396    | 50mA - 6.3A   | > 4 hr.           | < 60 sec. |

**Breaking Capacity:** 100A at 125VAC

| Amp Rating                    | Voltage Rating | Digi-Key Part No. | Bulk Price Each |      |      |
|-------------------------------|----------------|-------------------|-----------------|------|------|
|                               |                |                   | 1               | 10   | 100  |
| <b>Fast-Acting 395 Series</b> |                |                   |                 |      |      |
| .050                          | 125            | WK4322BK-ND       | 2.90            | 2.68 | 2.01 |
| .063                          | 125            | WK4325BK-ND       | 1.86            | 1.72 | 1.29 |
| .100                          | 125            | WK4327BK-ND       | .68             | .63  | .48  |
| .125                          | 125            | WK4328BK-ND       | .68             | .63  | .48  |
| .160                          | 125            | WK4330BK-ND       | .68             | .63  | .48  |
| .200                          | 125            | WK4334BK-ND       | .68             | .63  | .48  |
| .250                          | 125            | WK4335BK-ND       | .68             | .63  | .48  |
| .315                          | 125            | WK4337BK-ND       | .68             | .63  | .48  |
| .400                          | 125            | WK4340BK-ND       | .68             | .63  | .48  |
| .500                          | 125            | WK4341BK-ND       | .68             | .63  | .48  |
| .630                          | 125            | WK4343BK-ND       | .68             | .63  | .48  |
| .800                          | 125            | WK4346BK-ND       | .68             | .63  | .48  |
| 1.00                          | 125            | WK4348BK-ND       | .68             | .63  | .48  |
| 1.25                          | 125            | WK4350BK-ND       | .68             | .63  | .48  |
| 1.60                          | 125            | WK4353BK-ND       | .68             | .63  | .48  |
| 2.00                          | 125            | WK4357BK-ND       | .68             | .63  | .48  |
| 2.50                          | 125            | WK4358BK-ND       | .68             | .63  | .48  |
| 3.15                          | 125            | WK4324BK-ND       | .68             | .63  | .48  |
| 4.00                          | 125            | WK4362BK-ND       | .68             | .63  | .48  |
| 5.00                          | 125            | WK4363BK-ND       | .68             | .63  | .48  |
| 6.30                          | 125            | WK4366BK-ND       | .68             | .63  | .48  |
| <b>Time-Lag 396 Series</b>    |                |                   |                 |      |      |
| .063                          | 125            | WK4425BK-ND       | .97             | .90  | .68  |
| .080                          | 125            | WK4426BK-ND       | .97             | .90  | .68  |
| .100                          | 125            | WK4427BK-ND       | .86             | .80  | .60  |
| .125                          | 125            | WK4428BK-ND       | .86             | .80  | .60  |
| .160                          | 125            | WK4430BK-ND       | .86             | .80  | .60  |
| .200                          | 125            | WK4434BK-ND       | .72             | .67  | .50  |
| .250                          | 125            | WK4435BK-ND       | .72             | .67  | .50  |
| .315                          | 125            | WK4437BK-ND       | .72             | .67  | .50  |
| .400                          | 125            | WK4440BK-ND       | .72             | .67  | .50  |
| .500                          | 125            | WK4441BK-ND       | .72             | .67  | .50  |
| .630                          | 125            | WK4443BK-ND       | .72             | .67  | .50  |
| .800                          | 125            | WK4446BK-ND       | .72             | .67  | .50  |
| 1.00                          | 125            | WK4448BK-ND       | .72             | .67  | .50  |

| Amp Rating | Voltage Rating | Digi-Key Part No. | Bulk Price Each |     |     |
|------------|----------------|-------------------|-----------------|-----|-----|
|            |                |                   | 1               | 10  | 100 |
| 1.25       | 125            | WK4450BK-ND       | .72             | .67 | .50 |
| 1.60       | 125            | WK4453BK-ND       | .72             | .67 | .50 |
| 2.00       | 125            | WK4457BK-ND       | .72             | .67 | .50 |
| 2.50       | 125            | WK4458BK-ND       | .72             | .67 | .50 |
| 3.15       | 125            | WK4424BK-ND       | .72             | .67 | .50 |
| 4.00       | 125            | WK4462BK-ND       | .72             | .67 | .50 |
| 5.00       | 125            | WK4463BK-ND       | .72             | .67 | .50 |
| 6.30       | 125            | WK4466BK-ND       | .72             | .67 | .50 |

◆ **RoHS Compliant**

◆ **WK0117-KIT-ND Digi-Key® TE5 Sub-Miniature Fuse Kit**  
10 each of **TE5 Sub-Miniature Fuses** indicated and 20 each of **TE5 Fuseholders (WK0009-ND)** ..... **104.41**

**Wickmann® Brand Product**

**TR5 Sub-Miniature Fuses - IEC 60127-3**

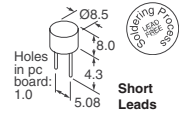

**Approvals:**

• **370 Series:** SEMKO Approved, cULus Recognized, CCC Approved (.050A - 5.00A), VDE Approved (.050A - 5.00A) Expert Report (6.30A), METI Approved (1.00A - 4.00A)

• **372 Series:** SEMKO Approved, cULus Recognized, CCC Approved (.050A - 6.30A), VDE Approved (.050A - 4.00A) Expert Report (5.00A, 6.30A), METI Approved (1.00A - 4.00A), Korean Approved (.050A - 6.30A)

• **382 Series:** SEMKO Approved and cULus Recognized (1.00A - 6.30A), CCC Approved (1.00A - 4.00A), VDE Approved (1.00A - 4.00A) Expert Report (5.00A, 6.30A), METI Approved (1.00A - 5.00A), Koren Approval (1.00A - 4.00A)

**Material:** • Base and Cap: Brown thermoplastic, Polyamide PA 6.6, UL 94V-0 • Round Pins: Copper alloy, tin-plated

**Features:** • Fast-acting and Time-lag • Soldering Heat Resistance: 260°C, 10 seconds (IEC 60068-2-20) • Plug-in holders available

**Electrical Characteristics:**



| Pre-arcing Rating                 |           |                |               |            |
|-----------------------------------|-----------|----------------|---------------|------------|
| 150%                              | 210%      | 275%           | 400%          | 1000%      |
| <b>Series 370 - 50mA - 6.30A</b>  |           |                |               |            |
| > 1 hr.                           | < 30 min. | 10ms - 3sec.   | 3 - 300ms     | < 20ms     |
| <b>Series 372 - 50mA - 6.30A</b>  |           |                |               |            |
| > 1 hr.                           | < 2 min.  | 400ms - 10sec. | 150ms - 3sec. | 20 - 150ms |
| <b>Series 382 - 1.00A - 6.30A</b> |           |                |               |            |
| > 1 hr.                           | < 2 min.  | 400ms - 10sec. | 150ms - 3sec. | 20 - 150ms |

**BREAKING CAPACITY:** 370 and 372 Series: 35A at 250VAC for (.050A - 3.15A), 40A for (4.00A), 50A for (5.00A, 6.30A) 382 Series: 100A at 250VAC (1.00A - 6.30A)

| Amp Rating                                      | Voltage Rating | Digi-Key Part No. | Bulk Price Each |      |      |
|---|----------------|-------------------|-----------------|------|------|
|   |                |                   | 1               | 10   | 100  |
| <b>Fast-Acting 370 Series (IEC 60127-3/III)</b> |                |                   |                 |      |      |
| .050  | 250            | WK4922BK-ND       | 2.45            | 2.27 | 1.71 |
| .063  | 250            | WK4925BK-ND       | 2.45            | 2.27 | 1.71 |
| .080  | 250            | WK4926BK-ND       | 2.45            | 2.27 | 1.71 |
| .100  | 250            | WK4927BK-ND       | .52             | .48  | .36  |
| .125  | 250            | WK4928BK-ND       | .52             | .48  | .36  |
| .160  | 250            | WK4930BK-ND       | .52             | .48  | .36  |
| .200  | 250            | WK4934BK-ND       | .52             | .48  | .36  |
| .250  | 250            | WK4935BK-ND       | .52             | .48  | .36  |
| .315  | 250            | WK4937BK-ND       | .52             | .48  | .36  |
| .400  | 250            | WK4940BK-ND       | .52             | .48  | .36  |
| .500  | 250            | WK4941BK-ND       | .52             | .48  | .36  |
| .630  | 250            | WK4943BK-ND       | .52             | .48  | .36  |
| .800  | 250            | WK4946BK-ND       | .52             | .48  | .36  |
| 1.00  | 250            | WK4948BK-ND       | .52             | .48  | .36  |
| 1.25  | 250            | WK4950BK-ND       | .52             | .48  | .36  |
| 1.60  | 250            | WK4953BK-ND       | .52             | .48  | .36  |
| 2.00  | 250            | WK4957BK-ND       | .52             | .48  | .36  |
| 2.50  | 250            | WK4958BK-ND       | .52             | .48  | .36  |
| 3.15  | 250            | WK4924BK-ND       | .52             | .48  | .36  |
| 4.00  | 250            | WK4962BK-ND       | .52             | .48  | .36  |
| 5.00  | 250            | WK4963BK-ND       | .52             | .48  | .36  |
| 6.30  | 250            | WK4964BK-ND       | .52             | .48  | .36  |
| <b>Time-Lag 372 Series (IEC 60127-3/IV)</b>     |                |                   |                 |      |      |
| .050  | 250            | WK4222BK-ND       | .69             | .64  | .48  |
| .063  | 250            | WK4225BK-ND       | .69             | .64  | .48  |
| .080  | 250            | WK4226BK-ND       | .56             | .52  | .39  |
| .100  | 250            | WK4227BK-ND       | .56             | .52  | .39  |
| .125  | 250            | WK4228BK-ND       | .56             | .52  | .39  |
| .160  | 250            | WK4230BK-ND       | .56             | .52  | .39  |
| .200  | 250            | WK4234BK-ND       | .56             | .52  | .39  |

◆ **RoHS Compliant**

† Conducting Path minimum: 2mm<sup>2</sup> (Continued)

**Free shipping on orders over £50! All prices are in British pound sterling and include duties.**

uk.digikey.com — FREEPHONE: 0-800-587-0991 • 0-800-904-7786 — FREEFAX: 0-800-587-0992 • 0-800-904-7783

(UK091) 1953

**TR5 Sub-Miniature Fuses – IEC 60127-3 (Cont.)**

| Amp Rating | Voltage Rating | Digi-Key Part No. | Bulk Price Each |     |     |
|------------|----------------|-------------------|-----------------|-----|-----|
|            |                |                   | 1               | 10  | 100 |
| .250       | 250            | WK4235BK-ND       | .56             | .52 | .39 |
| .315       | 250            | WK4237BK-ND       | .49             | .46 | .35 |
| .400       | 250            | WK4240BK-ND       | .49             | .46 | .35 |
| .500       | 250            | WK4241BK-ND       | .49             | .46 | .35 |
| .630       | 250            | WK4243BK-ND       | .49             | .46 | .35 |
| .800       | 250            | WK4246BK-ND       | .49             | .46 | .35 |
| 1.00       | 250            | WK4248BK-ND       | .49             | .46 | .35 |
| 1.25       | 250            | WK4250BK-ND       | .49             | .46 | .35 |
| 1.60       | 250            | WK4253BK-ND       | .49             | .46 | .35 |
| 2.00       | 250            | WK4257BK-ND       | .49             | .46 | .35 |
| 2.50       | 250            | WK4258BK-ND       | .49             | .46 | .35 |
| 3.15       | 250            | WK4224BK-ND       | .49             | .46 | .35 |
| 4.00       | 250            | WK4262BK-ND       | .49             | .46 | .35 |
| 5.00       | 250            | WK4263BK-ND       | .49             | .46 | .35 |
| 6.30       | 250            | WK4264BK-ND       | .49             | .46 | .35 |

**Time-Lag High Breaking**

**382 Series (IEC 60127-3/IV) – RoHS Compliant**

| Amp Rating | Voltage Rating | Digi-Key Part No. | 1   | 10  | 100 |
|------------|----------------|-------------------|-----|-----|-----|
| 1.00       | 250            | WK6207BK-ND       | .58 | .54 | .41 |
| 2.00       | 250            | WK6208BK-ND       | .58 | .54 | .41 |
| 2.50       | 250            | WK6209BK-ND       | .58 | .54 | .41 |
| 3.15       | 250            | WK6210BK-ND       | .58 | .54 | .41 |
| 4.00       | 250            | WK6211BK-ND       | .58 | .54 | .41 |
| 5.00       | 250            | WK6212BK-ND       | .58 | .54 | .41 |
| 6.30       | 250            | WK6213BK-ND       | .58 | .54 | .41 |

◆ RoHS Compliant † Conducting Path minimum: 2mm<sup>2</sup>

◆ **Digi-Key® TR5 Sub-Miniature Fuse IEC 60127-3 Kit** 10 each of **TR5 Sub-Miniature Fuses** indicated and 15 each of **TR5 Fuseholders (WK0001-ND)**  
**WK0113-KIT-ND – RoHS Compliant** ..... 90.58

**TR5 Sub-Miniature Fuses – UL 248-14**

**Approvals:**

**373 and 374 Series:** UL Listed, CSA Certified Approved (.050A – 10A)

**Material:** • Base and cap: Brown thermoplastic UL 94-V0, insulated • Round Pins: Copper alloy, tin-plated

**Features:** • Fast-acting and Time-lag • Soldering Heat Resistance: 260°C, 10 seconds, IEC-60068-2-20 • Plug-in holders available

**Electrical Characteristics:**

| Series | Rated Current | Pre-arcing Rating |                 |
|--------|---------------|-------------------|-----------------|
|        |               | 100%              | 200%            |
| 373    | 50mA – 10.A   | 4 hr. minimum     | 5 sec. maximum  |
| 374    | 50mA – 10.00A | 4 hr. minimum     | 60 sec. maximum |

| Amp Rating                    | Voltage Rating | Digi-Key Part No. | Bulk Price Each |      |      |
|-------------------------------|----------------|-------------------|-----------------|------|------|
|                               |                |                   | 1               | 10   | 100  |
| <b>Fast-Acting 373 Series</b> |                |                   |                 |      |      |
| .050                          | 250            | WK3022BK-ND       | 2.93            | 2.71 | 2.03 |
| .063                          | 250            | WK3025BK-ND       | 2.93            | 2.71 | 2.03 |
| .080                          | 250            | WK3026BK-ND       | 2.93            | 2.71 | 2.03 |
| .100                          | 250            | WK3027BK-ND       | .65             | .60  | .45  |
| .125                          | 250            | WK3028BK-ND       | .65             | .60  | .45  |
| .160                          | 250            | WK3030BK-ND       | .65             | .60  | .45  |
| .200                          | 250            | WK3034BK-ND       | .65             | .60  | .45  |
| .250                          | 250            | WK3035BK-ND       | .65             | .60  | .45  |
| .315                          | 250            | WK3037BK-ND       | .65             | .60  | .45  |
| .400                          | 250            | WK3040BK-ND       | .65             | .60  | .45  |
| .500                          | 250            | WK3041BK-ND       | .65             | .60  | .45  |
| .630                          | 250            | WK3043BK-ND       | .65             | .60  | .45  |
| .800                          | 250            | WK3046BK-ND       | .65             | .60  | .45  |
| 1.00                          | 250            | WK3048BK-ND       | .65             | .60  | .45  |
| 1.25                          | 250            | WK3050BK-ND       | .65             | .60  | .45  |
| 1.60                          | 250            | WK3053BK-ND       | .65             | .60  | .45  |
| 2.00                          | 250            | WK3057BK-ND       | .65             | .60  | .45  |
| 2.50                          | 250            | WK3058BK-ND       | .65             | .60  | .45  |
| 3.15                          | 250            | WK3024BK-ND       | .65             | .60  | .45  |
| 4.00                          | 250            | WK3062BK-ND       | .65             | .60  | .45  |
| 5.00                          | 250            | WK3063BK-ND       | .65             | .60  | .45  |
| 6.30                          | 250            | WK3066BK-ND       | .65             | .60  | .45  |
| 10.00                         | 250            | WK3071BK-ND       | .65             | .60  | .45  |

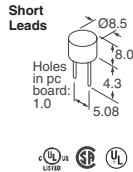

| Amp Rating                                  | Voltage Rating | Digi-Key Part No. | Bulk Price Each |     |     |
|---|----------------|-------------------|-----------------|-----|-----|
| <b>Time-Lag 374 Series – RoHS Compliant</b> |                |                   |                 |     |     |
| 1 10 100                                    |                |                   |                 |     |     |
| .050  | 250            | WK4022BK-ND       | 1.00            | .93 | .70 |
| .063  | 250            | WK4025BK-ND       | 1.00            | .93 | .70 |
| .080  | 250            | WK4026BK-ND       | .94             | .87 | .65 |
| .100  | 250            | WK4027BK-ND       | .94             | .87 | .65 |
| .125  | 250            | WK4028BK-ND       | .79             | .73 | .55 |
| .160  | 250            | WK4030BK-ND       | .79             | .73 | .55 |
| .200  | 250            | WK4034BK-ND       | .79             | .73 | .55 |
| .250  | 250            | WK4035BK-ND       | .72             | .67 | .50 |
| .315  | 250            | WK4037BK-ND       | .72             | .67 | .50 |
| .400  | 250            | WK4040BK-ND       | .65             | .60 | .45 |
| .500  | 250            | WK4041BK-ND       | .65             | .60 | .45 |
| .630  | 250            | WK4043BK-ND       | .65             | .60 | .45 |
| .800  | 250            | WK4046BK-ND       | .65             | .60 | .45 |
| 1.00  | 250            | WK4048BK-ND       | .65             | .60 | .45 |
| 1.25  | 250            | WK4050BK-ND       | .65             | .60 | .45 |
| 1.60  | 250            | WK4053BK-ND       | .65             | .60 | .45 |
| 2.00  | 250            | WK4057BK-ND       | .65             | .60 | .45 |
| 2.50  | 250            | WK4058BK-ND       | .65             | .60 | .45 |
| 3.15  | 250            | WK4024BK-ND       | .65             | .60 | .45 |
| 4.00  | 250            | WK4062BK-ND       | .65             | .60 | .45 |
| 5.00  | 250            | WK4063BK-ND       | .65             | .60 | .45 |
| 6.30  | 250            | WK4066BK-ND       | .65             | .60 | .45 |
| 10.00                                       | 250            | WK4071BK-ND       | .72             | .67 | .50 |

◆ RoHS Compliant

◆ **Digi-Key® TR5 Sub-Miniature Fuse UL-248-14 Kit** 10 each of **TR5 Sub-Miniature Fuses** indicated and 15 each of **TR5 Fuseholders (WK0001-ND)**  
**WK0116-KIT-ND – RoHS Compliant** ..... 103.75

**TR5 Panel Mount Fuseholder**

**Material:**

- Holder: Black thermoplastic UL 94V-0
- Polyamide PA
- Metal Parts: Copper alloy, solderable tinned
- Cap: Transparent thermoplastic polycarbonate PC, UL 94V-0

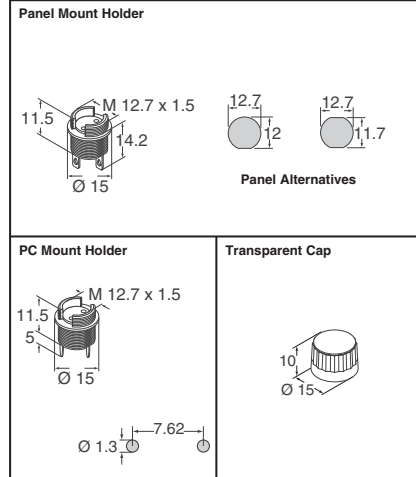

| Description        | Digi-Key Part No. | Price Each |     | Wickmann Part No. |
|--------------------|-------------------|------------|-----|-------------------|
| 1 10               |                   |            |     |                   |
| Panel Mount Holder | WK6224-ND         | .88        | .81 | 5700000000        |
| PC Mount Holder    | WK6225-ND         | .72        | .67 | 5710000000        |
| Transparent Cap    | WK6226-ND         | .33        | .31 | 5750000000        |

**TR5 / TE5 SMT Fuseholder**

**Material:** • Black thermoplastic UL 94-V0 • Terminals: Brass, tin-plated • UL Recognized

| Amp Rating | Voltage Rating | Digi-Key Part No. | Cut Tape Price Each |      | Tape & Reel Pricing† |
|------------|----------------|-------------------|---------------------|------|----------------------|
| 1 10       |                |                   |                     |      |                      |
| 6.3        | 250            | WK0010CT-ND       | 1.17                | 1.08 | 522.14/M             |

† For Tape and Reel Part Number, change CT-ND to TR-ND.

**TR5 Fuseholder**

**Material:** • Thermoplastic, UL 94V-0  
 • Polyester PCT • Terminals: brass, tin-plated  
**Rated Values:** 250V; 6.3A

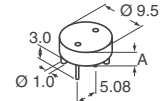

| Height (A) mm | Digi-Key Part No. | Price Each |     | Wickmann Part No. |
|---------------|-------------------|------------|-----|-------------------|
|               |                   | 1          | 10  |                   |
| 3.0           | WK0001-ND         | .59        | .55 | 5600000131        |
| 4.3           | WK6235-ND         | .48        | .45 | 5600000100        |

**UL / CSA Fuses Metric (5x20mm) – UL 248-14**

Equivalent to:

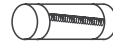

198 Series – Glass

| Wickmann   | Littelfuse | Bussmann |
|------------|------------|----------|
| 198 Series | 239        | GMD      |

**Approvals:**

**198 Series:** UL listed, CSA certified, .250A – 3.50A

**Electrical**

**Characteristics:**



| Series | Rated Current | Pre-arcing Rating |             |
|--------|---------------|-------------------|-------------|
|        |               | 135%              | 200%        |
| 198    | .250A – 2.50A | < 1 hr            | 5-120 sec.  |
|        | 3.50A         | < 1 hr            | 12-120 sec. |

**Breaking Capacity:**

**198 Series:** 35A at 250VAC (.250A – .800A); 100A at 250VAC (2.50A); 10,000A at 125VAC (.250A)

| Amp Rating                 | Voltage Rating | Digi-Key Part No. | Price Each |     |     |
|----------------------------|----------------|-------------------|------------|-----|-----|
| <b>Time-Lag 198 Series</b> |                |                   |            |     |     |
| 1 10 100                   |                |                   |            |     |     |
| .250                       | 250            | WK4835-ND         | .30        | .29 | .22 |

**Wickmann® Brand Product**

**IEC 60127-2 Metric (5x20mm) Fuses**



**Approvals:**

**194 Series:** SEMKO Approved, VDE Approved (0.200A – 6.30A), cULus Recognized (0.315A – 16A), CCC Approved (1.00A – 6.30A)

**195 Series:** SEMKO Approved, VDE Approved, BSI Approved, IMQ Approved, CCC Approved (0.032A – 6.30A), cULus Recognized (0.032A – 12.50A), METI Approved (1.00A – 5.00A)

**Electrical**

**Characteristics:**



| Series | Rated Current | Pre-arcing Rating |           |                 |                 |
|--------|---------------|-------------------|-----------|-----------------|-----------------|
|        |               | 150%              | 210%      | 400%            | 1000%           |
| 194    | 0.200 ~ 2.50A | > 1 hr.           | < 30 min. | 10ms ~ 2 sec.   | 3 ~ 300 ms      |
|        | 0.040 ~ .080A | > 1 hr.           | < 2 min.  | 200ms ~ 10 sec. | 40ms ~ 3 sec.   |
| 195    | .125 ~ 2.50A  | > 1 hr.           | < 2 min.  | 600ms ~ 10 sec. | 150 ms ~ 3 sec. |
|        |               |                   |           |                 | 20 ~ 300 ms     |

**BREAKING CAPACITY:** 194 Series: 1500A at 250VAC 195 Series: 35A at 250VAC for (.040 – 2.50A)

| Amp Rating  | Voltage Rating | Digi-Key Part No. | Price Each |     |     |
|---|----------------|-------------------|------------|-----|-----|
| <b>Fast Acting, High Breaking Capacity 194 Series</b> |                |                   |            |     |     |
| 1 10 100  |                |                   |            |     |     |
| .315  | 250            | WK2037-ND         | .70        | .65 | .49 |
| 1.60  | 250            | WK2053-ND         | .39        | .37 | .28 |
| <b>Time-Lag 195 Series</b>                            |                |                   |            |     |     |
| .080  | 250            | WK5026-ND         | .61        | .57 | .43 |
| <b>PC Board Mount (5x20mm) – RoHS Compliant</b>       |                |                   |            |     |     |
| –   | –              | WK0011-ND         | .27        | .25 | .19 |

Shock-Safe fuseholders for 1/4 x 1-1/4" (3AG) or 5 x 20mm fuses built according to UL 512 and IEC 60127-6 and CSA C22.2 No. 39 • VDE, SEMKO rated for use up to 250 Volts. • Casing made of black thermoplastic with UL 94V-0 ratings. Injection-molded terminals prevent intermittent connections. • PC Mount versions include additional pin(s) for added stability from torsional forces seen during fuse removal. • Panel Mount versions have combination 3/16" quick-connect/solderable tabs. • Body Material: White thermoplastic, UL 94V-0 rated (Wickmann Part No. 6490001009 only)

include additional pin(s) for added stability from torsional forces seen during fuse removal. • Panel Mount versions have combination 3/16" quick-connect/solderable tabs. • Body Material: White thermoplastic, UL 94V-0 rated (Wickmann Part No. 6490001009 only)

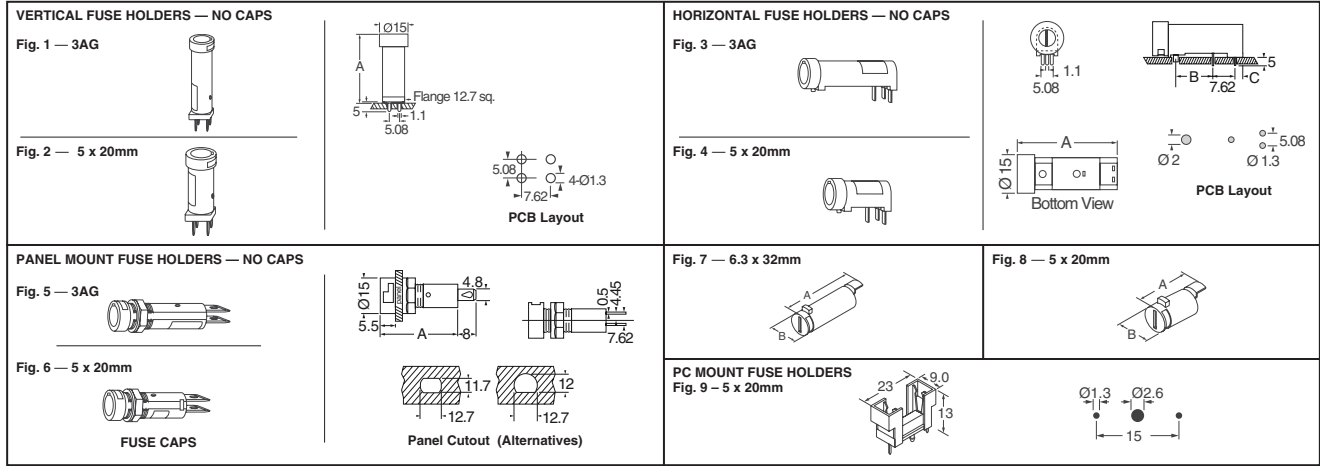

| Fig.  | Description                         | Dimensions - mm |       |      | Rated Current Amps VDE | UL/CSA (Amps) | Digi-Key Part No. | Price Each |      |      | Wickmann Part No. |
|---|-------------------------------------|-----------------|-------|------|------------------------|---------------|-------------------|------------|------|------|-------------------|
|   |                                     | A               | B     | C    |                        |               |                   | 1          | 10   | 100  |                   |
| 1   | Vertical 3AG (6.3 x 32mm) Holder    | 46.3            | —     | —    | 6.3                    | 16            | WK6229-ND*        | 1.09       | 1.01 | .76  | 8110000005        |
| 2   | Vertical (5 x 20mm) Holder          | 32.6            | —     | —    | 6.3                    | 16            | WK6233-ND*        | .84        | .78  | .59  | 8310000005        |
| 3   | Horizontal 3AG (6.3 x 32mm) Holder  | 45.7            | 27.94 | 1.90 | 6.3                    | 16            | WK6228-ND*        | 1.42       | 1.31 | .99  | 8100000005        |
| 4   | Horizontal (5 x 20mm) Holder        | 32.0            | 12.7  | 1.80 | 6.3                    | 16            | WK6232-ND*        | .81        | .76  | .57  | 8300000005        |
| 5   | Panel Mount 3AG (6.3 x 32mm) Holder | 45.7            | —     | —    | 10                     | 16            | WK6227-ND*        | 1.17       | 1.08 | .81  | 8000000005        |
| 6   | Panel Mount (5 x 20mm) Holder       | 32.0            | —     | —    | 6.3                    | 16            | WK6231-ND*        | .94        | .87  | .65  | 8200000005        |
| 7   | 3AG (6.3 x 32mm) Fuse Cap           | 33.8            | 9.20  | —    | —                      | —             | WK6230-ND*        | .86        | .79  | .60  | 8160000005        |
| 8   | (5 x 20mm) Fuse Cap                 | 20.6            | 9.20  | —    | —                      | —             | WK6234-ND*        | .60        | .56  | .42  | 8350000005        |
| 9   | PC Mount (5 x 20mm) Holder          | —               | —     | —    | 6.3                    | —             | WK0011-ND         | .27        | .25  | .19  | 6490001009        |
| <b>Digi-Key® Fuseholder Kit</b><br>1 each of WK6233-ND and WK6234-ND combined in a single bag |                                     |                 |       |      |                        |               |                   | —          | —    | —    | —                 |
|   |                                     |                 |       |      |                        |               |                   | 2.10       | 1.93 | 1.63 | —                 |

\* Fuse Cap and Holder are sold separate

**VISHAY. Beyschlag MFU Series Thin Film Chip Fuses**  
0402, 0603, 0805 and 1206 Sizes

**Applications:** • Information technology • Telecommunications • Industrial electronics • Audio/video electronics • Automotive electronics  
**Features:** • Advanced thin film technology • Very quick acting fuse characteristics • Outstanding stability of fusing characteristics • Precise repeatability of fusing characteristics • Compatible with lead-free and lead containing soldering processes

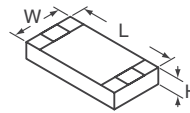

| Type     | Dimensions - mm  |                |             |
|----------|------------------|----------------|-------------|
|          | H                | L              | W           |
| MFU 0402 | 0.32 ± 0.05      | 1.0 ± 0.05     | 0.5 ± 0.05  |
| MFU 0603 | 0.45 ± 0.1/-0.05 | 1.55 ± 0.05    | 0.85 ± 0.1  |
| MFU 0805 | 0.45 ± 0.1/-0.05 | 2.0 ± 0.1      | 1.25 ± 0.15 |
| MFU 1206 | 0.55 ± 0.1       | 3.2 ± 0.1/-0.2 | 1.6 ± 0.15  |

| Voltage Rating (V) | Amp Rating (A) | Digi-Key Part No.     | Cut Tape Price Each   |     |     | Tape & Reel Pricing 1,000 | Vishay Part No.    |                    |
|--------------------|----------------|-----------------------|-----------------------|-----|-----|---------------------------|--------------------|--------------------|
|                    |                |                       | 1                     | 10  | 100 |                           |                    |                    |
| 0402               | 32             | .5 MFU0402.50CT-ND    | .47                   | .44 | .33 | 209.81                    | MFU0402FF00500E100 |                    |
|                    |                | .63 MFU0402.63CT-ND   | .47                   | .44 | .33 | 209.81                    | MFU0402FF00630E100 |                    |
|                    |                | .75 MFU0402.75CT-ND   | .47                   | .44 | .33 | 209.81                    | MFU0402FF00750E100 |                    |
|                    |                | .8 MFU0402.80CT-ND    | .47                   | .44 | .33 | 209.81                    | MFU0402FF00800E100 |                    |
|                    |                | 1 MFU0402.100CT-ND    | .36                   | .33 | .25 | 156.82                    | MFU0402FF01000E100 |                    |
|                    |                | 1.25 MFU0402.125CT-ND | .36                   | .33 | .25 | 156.82                    | MFU0402FF01250E100 |                    |
|                    | 0603           | 32                    | 1.5 MFU0402.150CT-ND  | .36 | .33 | .25                       | 156.82             | MFU0402FF01500E100 |
|                    |                |                       | 1.6 MFU0402.160CT-ND  | .36 | .33 | .25                       | 156.82             | MFU0402FF01600E100 |
|                    |                |                       | 1.75 MFU0402.175CT-ND | .36 | .33 | .25                       | 156.82             | MFU0402FF01750E100 |
|                    |                |                       | 2 MFU0402.200CT-ND    | .36 | .33 | .25                       | 156.82             | MFU0402FF02000E100 |
|                    |                |                       | .5 MFU0603.50CT-ND    | .34 | .32 | .24                       | 153.19             | MFU0603FF00500P100 |
|                    |                |                       | .63 MFU0603.63CT-ND   | .34 | .32 | .24                       | 151.01             | MFU0603FF00630P100 |
| 0805               |                | 32                    | .75 MFU0603.75CT-ND   | .34 | .32 | .24                       | 151.01             | MFU0603FF00750P100 |
|                    |                |                       | .8 MFU0603.80CT-ND    | .34 | .32 | .24                       | 151.01             | MFU0603FF00800P100 |
|                    |                |                       | 1 MFU0603.100CT-ND    | .25 | .24 | .19                       | 113.26             | MFU0603FF01000P100 |
|                    |                |                       | 1.25 MFU0603.125CT-ND | .25 | .24 | .19                       | 113.26             | MFU0603FF01250P100 |
|                    |                |                       | 1.5 MFU0603.150CT-ND  | .25 | .24 | .19                       | 113.26             | MFU0603FF01500P100 |
|                    |                |                       | 1.6 MFU0603.160CT-ND  | .25 | .24 | .19                       | 113.26             | MFU0603FF01600P100 |
|                    | 1206           | 63                    | 1.75 MFU0603.175CT-ND | .25 | .24 | .19                       | 113.26             | MFU0603FF01750P100 |
|                    |                |                       | 2 MFU0603.200CT-ND    | .25 | .24 | .19                       | 113.26             | MFU0603FF02000P100 |
|                    |                |                       | 2.5 MFU0603.250CT-ND  | .25 | .24 | .19                       | 113.26             | MFU0603FF02500P100 |
|                    |                |                       | 3 MFU0603.300CT-ND    | .25 | .24 | .19                       | 113.26             | MFU0603FF03000P100 |
|                    |                |                       | 3.15 MFU0603.315CT-ND | .25 | .24 | .19                       | 113.26             | MFU0603FF03150P100 |
|                    |                |                       | 3.5 MFU0603.350CT-ND  | .25 | .24 | .19                       | 113.26             | MFU0603FF03500P100 |
| 32                 |                | 4 MFU0603.400CT-ND    | .25                   | .24 | .19 | 113.26                    | MFU0603FF04000P100 |                    |
|                    |                | 5 MFU0603.500CT-ND    | .34                   | .32 | .24 | 156.82                    | MFU0603FF05000P100 |                    |
|                    |                | .5 MFU0805.50CT-ND    | .46                   | .43 | .32 | 204.01                    | MFU0805FF00500P100 |                    |
|                    |                | .63 MFU0805.63CT-ND   | .46                   | .43 | .32 | 204.01                    | MFU0805FF00630P100 |                    |
|                    |                | .75 MFU0805.75CT-ND   | .46                   | .43 | .32 | 204.01                    | MFU0805FF00750P100 |                    |
|                    |                | .8 MFU0805.80CT-ND    | .46                   | .43 | .32 | 204.01                    | MFU0805FF00800P100 |                    |

| Voltage Rating (V) | Amp Rating (A)        | Digi-Key Part No.      | Cut Tape Price Each |     |        | Tape & Reel Pricing 1,000 | Vishay Part No.    |
|--------------------|-----------------------|------------------------|---------------------|-----|--------|---------------------------|--------------------|
|                    |                       |                        | 1                   | 10  | 100    |                           |                    |
| 0805               | 32                    | 1 MFU0805.1.00CT-ND    | .34                 | .32 | .25    | 153.19                    | MFU0805FF01000P100 |
|                    |                       | 1.25 MFU0805.1.25CT-ND | .34                 | .32 | .25    | 153.19                    | MFU0805FF01250P100 |
|                    |                       | 1.5 MFU0805.1.50CT-ND  | .34                 | .32 | .25    | 153.19                    | MFU0805FF01500P100 |
|                    |                       | 1.6 MFU0805.1.60CT-ND  | .34                 | .32 | .25    | 153.19                    | MFU0805FF01600P100 |
|                    |                       | 1.75 MFU0805.1.75CT-ND | .34                 | .32 | .25    | 153.19                    | MFU0805FF01750P100 |
|                    |                       | 2 MFU0805.2.00CT-ND    | .34                 | .32 | .25    | 153.19                    | MFU0805FF02000P100 |
|                    | 63                    | 2.5 MFU0805.2.50CT-ND  | .34                 | .32 | .25    | 153.19                    | MFU0805FF02500P100 |
|                    |                       | 3 MFU0805.3.00CT-ND    | .34                 | .32 | .25    | 153.19                    | MFU0805FF03000P100 |
|                    |                       | 3.15 MFU0805.3.15CT-ND | .34                 | .32 | .25    | 153.19                    | MFU0805FF03150P100 |
|                    |                       | 3.5 MFU0805.3.50CT-ND  | .34                 | .32 | .25    | 153.19                    | MFU0805FF03500P100 |
|                    |                       | 4 MFU0805.4.00CT-ND    | .34                 | .32 | .25    | 153.19                    | MFU0805FF04000P100 |
|                    |                       | 5 MFU0805.5.00CT-ND    | .46                 | .43 | .33    | 211.27                    | MFU0805FF05000P100 |
| 1206               | 63                    | .5 MFU1206.50CT-ND     | .56                 | .52 | .39    | 249.74                    | MFU1206FF00500P100 |
|                    |                       | .63 MFU1206.63CT-ND    | .56                 | .52 | .39    | 249.74                    | MFU1206FF00630P100 |
|                    |                       | .75 MFU1206.75CT-ND    | .56                 | .52 | .39    | 249.74                    | MFU1206FF00750P100 |
|                    |                       | .8 MFU1206.80CT-ND     | .56                 | .52 | .39    | 249.74                    | MFU1206FF00800P100 |
|                    |                       | 1 MFU1206.100CT-ND     | .42                 | .39 | .30    | 186.58                    | MFU1206FF01000P100 |
|                    |                       | 1.25 MFU1206.125CT-ND  | .42                 | .39 | .30    | 186.58                    | MFU1206FF01250P100 |
|                    | 32                    | 1.5 MFU1206.150CT-ND   | .42                 | .39 | .30    | 186.58                    | MFU1206FF01500P100 |
|                    |                       | 1.6 MFU1206.160CT-ND   | .42                 | .39 | .30    | 186.58                    | MFU1206FF01600P100 |
|                    |                       | 1.75 MFU1206.175CT-ND  | .42                 | .39 | .30    | 186.58                    | MFU1206FF01750P100 |
|                    |                       | 2 MFU1206.200CT-ND     | .42                 | .39 | .30    | 186.58                    | MFU1206FF02000P100 |
|                    |                       | 2.5 MFU1206.250CT-ND   | .42                 | .39 | .30    | 186.58                    | MFU1206FF02500P100 |
|                    |                       | 3 MFU1206.300CT-ND     | .42                 | .39 | .30    | 186.58                    | MFU1206FF03000P100 |
| 32                 | 3.15 MFU1206.315CT-ND | .42                    | .39                 | .30 | 186.58 | MFU1206FF03150P100        |                    |
|                    | 3.5 MFU1206.350CT-ND  | .42                    | .39                 | .30 | 186.58 | MFU1206FF03500P100        |                    |
|                    | 4 MFU1206.400CT-ND    | .42                    | .39                 | .30 | 186.58 | MFU1206FF04000P100        |                    |
|                    | 5 MFU1206.500CT-ND    | .42                    | .39                 | .30 | 186.58 | MFU1206FF05000P100        |                    |
|                    | 6.3 MFU1206.630CT-ND  | .57                    | .53                 | .40 | 259.18 | MFU1206FF06300P100        |                    |

‡ For Tape and Reel part number, change CT-ND to TR-ND.

**Digi-Reel®** Most SMT cutdown parts are available on a Digi-Reel®. For Digi-Reel part number, change 1-ND to 6-ND or CT-ND to DKR-ND. See Digi-Key® Services on page 2 for additional information.

**Free shipping on orders over £50! All prices are in British pound sterling and include duties.**

uk.digikey.com — FREEPHONE: 0-800-587-0991 • 0-800-904-7786 — FREEFAX: 0-800-587-0992 • 0-800-904-7783

(UK091) 1955