



## .0197" (0.5mm) High Speed Sockets and Headers QSH and QTH Series



**Specifications: (QSH Series)** • Insulator Material: Liquid Crystal Polymer • Contact Material: Phosphor Bronze • Plating: Gold over 50µ" (1.27µm) Nickel • Current Rating: 1.0A @ 30°C Temperature Rise (contact); 7.8A @ 30°C Temperature Rise (ground plane) • Operating Temperature: -55°C - 125°C • Voltage Rating: 125VAC mated with QTH and 5mm Stack Height • Mates with: QTH

**Specifications: (QTH Series)** • Insulator Material: Liquid Crystal Polymer • Terminal Material: Phosphor Bronze • Plating: Gold over 50µ" (1.27µm) Nickel • Current Rating: 1.0A @ 30°C Temperature Rise (contact); 7.8A @ 30°C Temperature Rise (ground plane) • Operating Temperature: -55°C - 125°C • Voltage Rating: 125VAC mated with QSH and 5mm Stack Height • Mates with: QSH

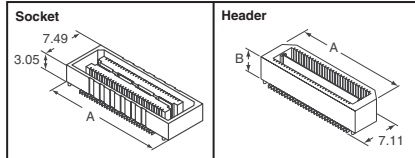

No. of Pos.	Dimensions (mm)		Digi-Key Part No.	Price Each		
	A	B		1	10	100
<b>Sockets</b>						
60	41.27		SAM8180-ND	6.43	4.83	4.02
120	81.27		SAM8181-ND	7.05	5.37	4.60
180	121.27		SAM8182-ND	9.47	7.29	6.11
240	161.27		SAM8183-ND	11.23	8.68	7.41
300	201.27		SAM8184-ND	13.39	10.84	9.09
<b>Headers</b>						
60	40.00	4.27	SAM8185-ND	6.55	4.92	4.10
		7.26	SAM8186-ND	6.76	5.07	4.23
		10.27	SAM8187-ND	9.92	7.80	6.54
120	80.00	4.27	SAM8188-ND	10.25	8.07	6.76
		7.26	SAM8189-ND	7.18	5.47	4.69
		10.27	SAM8190-ND	7.40	5.63	4.83
180	120.00	4.27	SAM8191-ND	11.34	8.77	7.48
		7.26	SAM8192-ND	11.71	9.05	7.72
		10.27	SAM8193-ND	9.66	7.43	6.23
240	160.00	7.26	SAM8194-ND	9.73	7.65	6.42
		10.27	SAM8195-ND	14.88	11.70	10.10
		15.26	SAM8196-ND	14.64	11.93	10.25
300	200.00	4.27	SAM8197-ND	11.43	8.84	7.54
		7.26	SAM8198-ND	11.79	9.11	7.77
		10.27	SAM8199-ND	17.16	13.99	12.02
		15.26	SAM8200-ND	17.74	14.47	12.43
		4.27	SAM8201-ND	13.65	11.05	9.26
		7.26	SAM8202-ND	14.06	11.05	9.54
		10.27	SAM8203-ND	21.46	17.49	15.03
		15.26	SAM8204-ND	21.62	17.74	15.53

## .0315" (0.80mm) High Speed Sockets and Headers QSE and QTE Series



**Specifications:** • Insulator Material: Liquid Crystal Polymer • Terminal Material: Phosphor Bronze • Plating: Gold over 50µ" (1.27µm) Nickel • Current Rating: Contacts: 2A @ 80°C Ground Plane: 9.5A @ 80°C • Operating Temperature Range: -55°C - 125°C • Voltage Rating: (QSE) 225VAC mated with QSE and 5mm Stack Height • Voltage Rating: (QTE) 225VAC mated with QTE and 5mm Stack Height • QTE Series Mates with QSE • QSE Series Mates with QTE

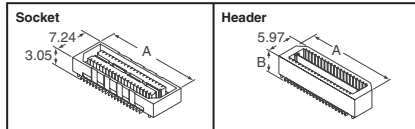

No. of Pos.	Dimensions (mm)		Digi-Key Part No.	Price Each		
	A	B		1	10	100
<b>Sockets</b>						
40	21.27		SAM8123-ND	4.65	3.40	2.77
80	41.27		SAM8124-ND	6.13	4.60	3.84
120	61.27		SAM8125-ND	7.05	5.37	4.60
160	81.27		SAM8126-ND	8.41	6.47	5.43
200	101.27		SAM8127-ND	9.58	7.36	6.17
<b>Headers</b>						
40	20.00	4.27	SAM8128-ND	4.56	3.38	2.79
		7.26	SAM8129-ND	4.70	3.48	2.88
		10.27	SAM8130-ND	5.68	4.09	3.41
		15.24	SAM8131-ND	7.14	5.44	4.67
80	40.00	4.27	SAM8132-ND	6.24	4.68	3.90
		7.26	SAM8133-ND	6.43	4.83	4.02
		10.27	SAM8134-ND	7.46	5.68	4.87
		15.24	SAM8135-ND	9.76	7.68	6.44

No. of Pos.	Dimensions (mm)		Digi-Key Part No.	Price Each		
	A	B		1	10	100
120	60.00	4.27	SAM8136-ND	7.18	5.47	4.69
		7.26	SAM8137-ND	7.40	5.63	4.83
		10.27	SAM8138-ND	8.76	6.74	5.65
		15.24	SAM8139-ND	11.71	9.05	7.72
160	80.00	4.27	SAM8140-ND	8.57	6.60	5.53
		7.26	SAM8141-ND	8.84	6.80	5.70
		10.27	SAM8142-ND	10.48	8.24	6.91
		15.24	SAM8143-ND	13.66	11.06	9.27
200	100.00	4.27	SAM8144-ND	9.75	7.50	6.29
		7.26	SAM8145-ND	9.82	7.73	6.48
		10.27	SAM8146-ND	11.90	9.20	7.85
		15.24	SAM8147-ND	14.78	12.05	10.35

## .0315" (0.08mm) Edge Rate Sockets and Headers ERF8 and ERM8 Series



**Specifications:** • Insulator Material: Black LCP • Terminal Material: Phosphor Bronze • Plating: Gold or Tin over 50µ" (1.27µm) Nickel • Operating Temperature Range: -55°C - 125°C • ERF8 Contact Material: BeCu

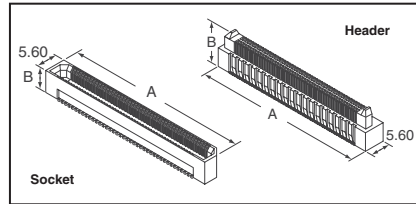

No. of Pos.	Dimensions (mm)		Digi-Key Part No.	Price Each		
	A	B		1	10	100
<b>Sockets</b>						
20	14	5.10	SAM8618-ND	4.32	3.16	2.58
40	22	5.10	SAM8619-ND	4.68	3.47	2.87
60	30	5.10	SAM8620-ND	6.05	5.44	3.63
80	38	5.10	SAM8621-ND	6.45	5.91	4.03
100	46	5.10	SAM8622-ND	6.98	5.10	4.37
120	54	5.10	SAM8623-ND	7.41	5.65	4.84
140	62	5.10	SAM8624-ND	7.94	6.04	5.18
150	66	5.10	SAM8625-ND	8.12	6.18	5.30
<b>Headers</b>						
20	14	5.97	SAM8602-ND	4.13	3.03	2.47
40	22	5.97	SAM8603-ND	4.68	3.43	2.80
60	30	5.97	SAM8604-ND	5.81	4.19	3.49
80	38	5.97	SAM8605-ND	6.19	4.64	3.87
100	46	5.97	SAM8606-ND	6.71	5.04	4.20
120	54	5.97	SAM8607-ND	7.11	5.42	4.64
140	62	5.97	SAM8608-ND	7.62	5.80	4.97
150	66	5.97	SAM8609-ND	7.78	5.93	5.08
20	14	8.91	SAM8610-ND	4.32	3.16	2.58
40	22	8.91	SAM8611-ND	4.68	3.47	2.87
60	30	8.91	SAM8612-ND	5.80	4.36	3.63
80	38	8.91	SAM8613-ND	6.45	5.91	4.03
100	46	8.91	SAM8614-ND	6.98	5.10	4.37
120	54	8.91	SAM8615-ND	7.41	5.65	4.84
140	62	8.91	SAM8616-ND	7.94	6.04	5.18
150	66	8.91	SAM8617-ND	8.12	6.18	5.30

## .0315" (0.80mm) Sockets CLE Series



**Specifications:** • Insulator Material: Black Liquid Crystal Polymer • Contact Material: Beryllium Copper • Plating: Gold over 50µ" (1.27µm) Nickel • Current Rating: .75A @ 80°C ambient • Operating Temperature: -55°C - 125°C • Contact Resistance: 15 mΩ max. (initial) • Mates with: FTE Series

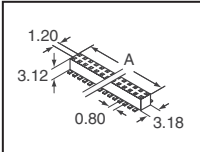

No. of Pos.	Dim. A (mm)	Digi-Key Part No.†	Price Each		
			1	10	100
2	0.8	SAM1142-01-ND	5.72	5.12	4.22
4	1.6	SAM1142-02-ND	5.86	5.24	4.32
6	2.4	SAM1142-03-ND	6.00	5.37	4.42
8	3.2	SAM1142-04-ND	6.13	5.49	4.52
10	4.0	SAM1142-05-ND	6.27	5.61	4.62
12	4.8	SAM1142-06-ND	6.41	5.74	4.73
14	5.6	SAM1142-07-ND	6.55	5.86	4.83
16	6.4	SAM1142-08-ND	6.69	5.98	4.93
18	7.2	SAM1142-09-ND	6.82	6.11	5.03
20	8.0	SAM1142-10-ND	6.96	6.23	5.13
22	8.8	SAM1142-11-ND	7.10	6.35	5.23
24	9.6	SAM1142-12-ND	7.24	6.48	5.34

† More product available online. For pricing and availability, visit our website.

## .0315" (0.80mm) Headers FTE Series



**Specifications:** • Insulator Material: Black Liquid Crystal Polymer • Terminal Material: Phosphor Bronze • Plating: Gold over 50µ" (1.27µm) Nickel • Current Rating: .75A @ 80°C ambient • Operating Temperature: -55°C - 125°C • Mates with: CLE Series

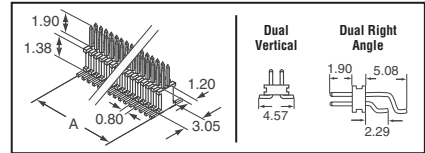

No. of Pos.	Dim. A (mm)	Digi-Key Part No.†	Price Each		
			1	10	100
<b>Dual Row, Vertical</b>					
2	0.8	SAM1144-01-ND	6.11	5.47	4.51
4	1.6	SAM1144-02-ND	6.25	5.60	4.61
6	2.4	SAM1144-03-ND	6.39	5.72	4.71
8	3.2	SAM1144-04-ND	6.53	5.84	4.81
10	4.0	SAM1144-05-ND	6.66	5.97	4.91
12	4.8	SAM1144-06-ND	6.80	6.09	5.02
14	5.6	SAM1144-07-ND	6.94	6.21	5.12
16	6.4	SAM1144-08-ND	7.08	6.34	5.22
18	7.2	SAM1144-09-ND	7.22	6.46	5.32
20	8.0	SAM1144-10-ND	7.35	6.58	5.42
22	8.8	SAM1144-11-ND	7.49	6.71	5.52
24	9.6	SAM1144-12-ND	7.63	6.83	5.63
<b>Dual Row, Right Angle</b>					
2	0.8	SAM1143-01-ND	7.93	7.10	5.85
4	1.6	SAM1143-02-ND	8.11	7.20	5.98
6	2.4	SAM1143-03-ND	8.29	7.42	6.11
8	3.2	SAM1143-04-ND	8.47	7.58	6.25
10	4.0	SAM1143-05-ND	8.65	7.74	6.38
12	4.8	SAM1143-06-ND	8.83	7.90	6.51
14	5.6	SAM1143-07-ND	9.01	8.06	6.64
16	6.4	SAM1143-08-ND	9.18	8.22	6.77
18	7.2	SAM1143-09-ND	9.37	8.38	6.91
20	8.0	SAM1143-10-ND	9.55	8.55	7.04
22	8.8	SAM1143-11-ND	9.73	8.71	7.17
24	9.6	SAM1143-12-ND	9.90	8.87	7.30

† More product available online. For pricing and availability, visit our website.

## .040" (1.00mm) Low Profile Sockets CLM Series



**Specifications:** • Insulator Material: Liquid Crystal Polymer • Contact Material: Phosphor Bronze • Plating: Pre-plated 10µ" (0.25µm) Gold on contact, Tin-Lead on Tail • Current Rating: 1.5A @ 80°C • Operating Temperature: -55°C - 125°C • Contact Resistance: 15mΩ max. • Mates with: FTMH Series

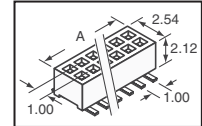

No. of Pos.	Dim. A (mm)	Digi-Key Part No.†	Price Each		
			1	10	100
2	1.43	SAM1129-01-ND	3.53	3.16	2.61
4	2.43	SAM1129-02-ND	3.68	3.30	2.72
6	3.43	SAM1129-03-ND	3.83	3.44	2.83
8	4.43	SAM1129-04-ND	3.99	3.57	2.94
10	5.43	SAM1129-05-ND	4.14	3.71	3.05
12	6.43	SAM1129-06-ND	4.29	3.84	3.17
14	7.43	SAM1129-07-ND	4.44	3.98	3.28
16	8.43	SAM1129-08-ND	4.60	4.11	3.39
18	9.43	SAM1129-09-ND	4.75	4.25	3.50
20	10.43	SAM1129-10-ND	4.90	4.39	3.61
22	11.43	SAM1129-11-ND	5.05	4.52	3.72
24	12.43	SAM1129-12-ND	5.20	4.66	3.84

† More product available online. For pricing and availability, visit our website.

## .040" (1.00mm) Micro Headers FTMH Series



**Specifications:** • Insulator Material: Black Liquid Crystal Polymer • Terminal Material: Phosphor Bronze • Current Rating: 1.5A @ 80°C ambient • Operating Temperature: -55°C - 125°C • Mates with: CLM, MLE Series

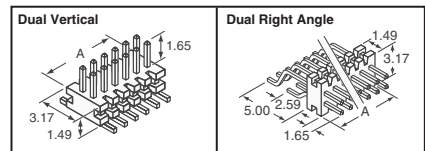

No. of Pos.</
---------------

**samtec** .040" (1.00mm) Micro Headers FTMH Series (Cont.)

No. of Pos.	Dim. A (mm)	Digi-Key Part No.†	Price Each		
			1	10	100
10	10	SAM1131-05-ND	4.59	4.11	3.38
12	12	SAM1131-06-ND	4.70	4.21	3.47
14	14	SAM1131-07-ND	4.82	4.32	3.56
16	16	SAM1131-08-ND	4.94	4.42	3.64
18	18	SAM1131-09-ND	5.05	4.53	3.73
20	20	SAM1131-10-ND	5.18	4.63	3.82
22	22	SAM1131-11-ND	5.29	4.74	3.90
24	24	SAM1131-12-ND	5.41	4.84	3.99

**Dual Row, Right Angle**

2	2	SAM1130-01-ND	5.39	4.83	3.98
4	4	SAM1130-02-ND	5.55	4.97	4.09
6	6	SAM1130-03-ND	5.70	5.10	4.20
8	8	SAM1130-04-ND	5.85	5.24	4.31
10	10	SAM1130-05-ND	6.00	5.37	4.43
12	12	SAM1130-06-ND	6.15	5.51	4.54
14	14	SAM1130-07-ND	6.30	5.64	4.65
16	16	SAM1130-08-ND	6.45	5.78	4.76
18	18	SAM1130-09-ND	6.61	5.92	4.87
20	20	SAM1130-10-ND	6.76	6.05	4.99
22	22	SAM1130-11-ND	6.91	6.19	5.10
24	24	SAM1130-12-ND	7.06	6.32	5.21

† More product available online. For pricing and availability, visit our website.

**.040" (1.00mm) Standard Sockets MLE Series**

**Specifications:**

- Insulator Material: Black Liquid Crystal Polymer
- Contact Material: Beryllium Copper
- Operating Temperature: -55°C ~ 125°C
- Plating: Gold over 10µ" (0.25µm) Nickel
- Mates with: FTMH Series

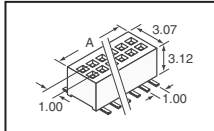

No. of Pos.	Dim. A (mm)	Digi-Key Part No.†	Price Each		
			1	10	100
2	1.2	SAM1132-01-ND	5.15	4.61	3.80
4	2.2	SAM1132-02-ND	5.30	4.74	3.91
6	3.2	SAM1132-03-ND	5.45	4.87	4.01
8	4.2	SAM1132-04-ND	5.59	5.00	4.12
10	5.2	SAM1132-05-ND	5.73	5.13	4.23
12	6.2	SAM1132-06-ND	5.87	5.26	4.33
14	7.2	SAM1132-07-ND	6.02	5.39	4.44
16	8.2	SAM1132-08-ND	6.16	5.52	4.55
18	9.2	SAM1132-09-ND	6.31	5.65	4.65
20	10.2	SAM1132-10-ND	6.45	5.78	4.76
22	11.2	SAM1132-11-ND	6.60	5.91	4.87
24	12.2	SAM1132-12-ND	6.74	6.04	4.98

† More product available online. For pricing and availability, visit our website.

**.050" (1.27mm) Low Profile Sockets CLP Series**

**Specifications:**

- Insulator Material: Black Liquid Crystal Polymer
- Contact Material: Phosphor Bronze
- Current Rating: 1.75A @ 80°C ambient
- Operating Temperature: -55°C ~ 125°C
- Contact Resistance: 10mΩ max.
- Mates with: FTS, FTS Series

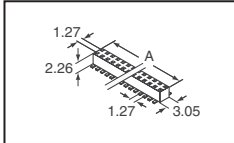

No. of Pos.	Dim. A (mm)	Digi-Key Part No.†	Price Each		
			1	10	100
<b>10µ" (0.25µm) Gold Plating</b>					
4	2.97	SAM1154-02-ND	3.38	3.03	2.50
6	4.24	SAM1154-03-ND	3.51	3.15	2.59
8	5.51	SAM1154-04-ND	3.64	3.26	2.69
10	6.78	SAM1154-05-ND	3.78	3.38	2.78
12	8.05	SAM1154-06-ND	3.91	3.50	2.88
14	9.32	SAM1154-07-ND	4.04	3.61	2.98
16	10.59	SAM1154-08-ND	4.17	3.73	3.07
18	11.86	SAM1154-09-ND	4.30	3.85	3.17
20	13.13	SAM1154-10-ND	4.43	3.97	3.27
22	14.40	SAM1154-11-ND	4.56	4.08	3.36
24	15.67	SAM1154-12-ND	4.69	4.20	3.46
26	16.94	SAM1154-13-ND	4.82	4.32	3.56

**10µ" (0.25µm) Gold on Contact, Matte Tin on Tail**

4	2.97	SAM1155-02-ND	3.11	2.79	2.30
6	4.24	SAM1155-03-ND	3.25	2.91	2.40
8	5.51	SAM1155-04-ND	3.38	3.03	2.50
10	6.78	SAM1155-05-ND	3.51	3.15	2.59
12	8.05	SAM1155-06-ND	3.64	3.26	2.69
14	9.32	SAM1155-07-ND	3.78	3.38	2.78
16	10.59	SAM1155-08-ND	3.91	3.50	2.88
18	11.86	SAM1155-09-ND	4.04	3.61	2.98
20	13.13	SAM1155-10-ND	4.17	3.73	3.07
22	14.40	SAM1155-11-ND	4.30	3.85	3.17
24	15.67	SAM1155-12-ND	4.43	3.97	3.27
26	16.94	SAM1155-13-ND	4.56	4.08	3.36

† More product available online. For pricing and availability, visit our website.

No. of Pos.	Dim. A (mm)	Digi-Key Part No.†	Price Each		
			1	10	100
<b>Gold Flash on Contact, Matte Tin on Tail</b>					
4	2.97	SAM1153-02-ND	2.85	2.55	2.10
6	4.24	SAM1153-03-ND	2.96	2.66	2.19
8	5.51	SAM1153-04-ND	3.09	2.76	2.28
10	6.78	SAM1153-05-ND	3.20	2.87	2.36
12	8.05	SAM1153-06-ND	3.32	2.97	2.45
14	9.32	SAM1153-07-ND	3.43	3.08	2.54
16	10.59	SAM1153-08-ND	3.55	3.18	2.62
18	11.86	SAM1153-09-ND	3.67	3.29	2.71
20	13.13	SAM1153-10-ND	3.79	3.39	2.79
22	14.40	SAM1153-11-ND	3.91	3.50	2.88
24	15.67	SAM1153-12-ND	4.02	3.60	2.97
26	16.94	SAM1153-13-ND	4.14	3.71	3.05

† More product available online. For pricing and availability, visit our website.

**.050" x .050" (1.27mm x 1.27mm) Micro Strips**

**FTS Series**

**Specifications:**

- Insulator Material: Black Liquid Crystal Polymer
- Terminal Material: Phosphor Bronze
- Current Rating: 1.75A @ 80°C ambient
- Operating Temperature: -55°C ~ 125°C
- Plating: 10µ" (25µm) Gold on post, Tin on Tail
- Mates with: FFS, CLP, FLE Series

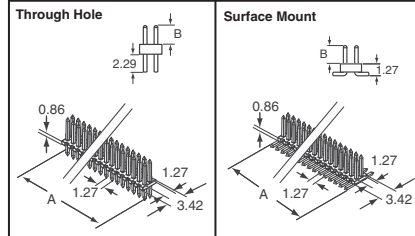

No. of Pos.	Dim. (mm)	Digi-Key Part No.†	Price Each			
			1	10	100	
<b>Through Hole</b>						
<b>Mates with CLP Series</b>						
4	2.54	1.65	SAM1158-02-ND	2.37	2.13	1.75
6	3.81	1.65	SAM1158-03-ND	2.47	2.21	1.82
8	5.08	1.65	SAM1158-04-ND	2.56	2.30	1.90
10	6.35	1.65	SAM1158-05-ND	2.66	2.39	1.97
12	7.62	1.65	SAM1158-06-ND	2.76	2.47	2.04
14	8.89	1.65	SAM1158-07-ND	2.85	2.56	2.11
16	10.16	1.65	SAM1158-08-ND	2.95	2.65	2.18
18	11.43	1.65	SAM1158-09-ND	3.05	2.73	2.25
20	12.70	1.65	SAM1158-10-ND	3.14	2.82	2.32
22	13.97	1.65	SAM1158-11-ND	3.25	2.90	2.39
24	15.24	1.65	SAM1158-12-ND	3.34	2.99	2.46
26	16.51	1.65	SAM1158-13-ND	3.43	3.08	2.54

<b>Mates with FFS Series</b>						
4	2.54	3.05	SAM1156-02-ND	2.37	2.13	1.75
6	3.81	3.05	SAM1156-03-ND	2.47	2.21	1.82
8	5.08	3.05	SAM1156-04-ND	2.56	2.30	1.90
10	6.35	3.05	SAM1156-05-ND	2.66	2.39	1.97
12	7.62	3.05	SAM1156-06-ND	2.76	2.47	2.04
14	8.89	3.05	SAM1156-07-ND	2.85	2.56	2.11
16	10.16	3.05	SAM1156-08-ND	2.95	2.65	2.18
18	11.43	3.05	SAM1156-09-ND	3.05	2.73	2.25
20	12.70	3.05	SAM1156-10-ND	3.14	2.82	2.32
22	13.97	3.05	SAM1156-11-ND	3.25	2.90	2.39
24	15.24	3.05	SAM1156-12-ND	3.34	2.99	2.46
26	16.51	3.05	SAM1156-13-ND	3.43	3.08	2.54

No. of Pos.	Dim. (mm)	Digi-Key Part No.†	Price Each			
			1	10	100	
<b>Surface Mount</b>						
<b>Mates with CLP Series</b>						
4	2.54	1.65	SAM1159-02-ND	2.74	2.46	2.03
6	3.81	1.65	SAM1159-03-ND	2.85	2.55	2.10
8	5.08	1.65	SAM1159-04-ND	2.95	2.65	2.18
10	6.35	1.65	SAM1159-05-ND	3.06	2.74	2.26
12	7.62	1.65	SAM1159-06-ND	3.16	2.83	2.33
14	8.89	1.65	SAM1159-07-ND	3.26	2.92	2.41
16	10.16	1.65	SAM1159-08-ND	3.37	3.02	2.48
18	11.43	1.65	SAM1159-09-ND	3.47	3.11	2.56
20	12.70	1.65	SAM1159-10-ND	3.57	3.20	2.64
22	13.97	1.65	SAM1159-11-ND	3.67	3.29	2.71
24	15.24	1.65	SAM1159-12-ND	3.78	3.39	2.79
26	16.51	1.65	SAM1159-13-ND	3.88	3.48	2.87

<b>Mates with FFS Series</b>						
4	2.54	3.05	SAM1157-02-ND	2.74	2.46	2.03
6	3.81	3.05	SAM1157-03-ND	2.85	2.55	2.10
8	5.08	3.05	SAM1157-04-ND	2.95	2.65	2.18
10	6.35	3.05	SAM1157-05-ND	3.06	2.74	2.26
12	7.62	3.05	SAM1157-06-ND	3.16	2.83	2.33
14	8.89	3.05	SAM1157-07-ND	3.26	2.92	2.41
16	10.16	3.05	SAM1157-08-ND	3.37	3.02	2.48
18	11.43	3.05	SAM1157-09-ND	3.47	3.11	2.56
20	12.70	3.05	SAM1157-10-ND	3.57	3.20	2.64
22	13.97	3.05	SAM1157-11-ND	3.67	3.29	2.71
24	15.24	3.05	SAM1157-12-ND	3.78	3.39	2.79
26	16.51	3.05	SAM1157-13-ND	3.88	3.48	2.87

† More product available online. For pricing and availability, visit our website.

**.050" (1.27mm) Micro Headers FTSH Series**

**Specifications:**

- Insulator Material: Black Liquid Crystal Polymer
- Terminal Material: Phosphor Bronze
- Plating: 10µ" (25µm) Gold on post, Matte Tin on Tail
- Current Rating: 1.75A @ 80°C ambient
- Operating Temperature: -55°C ~ 125°C
- Mates with: FFS, CLP, FLE Series

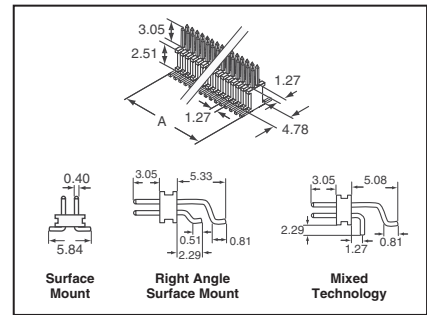

No. of Pos.	Dim. A (mm)	Digi-Key Part No.†	Price Each		
			1	10	100
<b>Surface Mount</b>					
4	2.54	SAM1161-02-ND	2.74	2.46	2.03
6	3.81	SAM1161-03-ND	2.85	2.55	2.10
8	5.08	SAM1161-04-ND	2.95	2.65	2.18
10	6.35	SAM1161-05-ND	3.06	2.74	2.26
12	7.62	SAM1161-06-ND	3.16	2.83	2.33
14	8.89	SAM1161-07-ND	3.26	2.92	2.41
16	10.16	SAM1161-08-ND	3.37	3.02	2.48
18	11.43	SAM1161-09-ND	3.47	3.11	2.56
20	12.70	SAM1161-10-ND	3.57	3.20	2.64
22	13.97	SAM1161-11-ND	3.67	3.29	2.71
24	15.24	SAM1161-12-ND	3.78	3.39	2.79
26	16.51	SAM1161-13-ND	3.88	3.48	2.87

<b>Right Angle Surface Mount</b>					
4	2.54	SAM1160-02-ND	3.16	2.83	2.33
6	3.81	SAM1160-03-ND	3.28	2.94	2.42
8	5.08	SAM1160-04-ND	3.40	3.05	2.52
10	6.35	SAM1160-05-ND	3.53	3.16	2.61
12	7.62	SAM1160-06-ND	3.66	3.28	2.70
14	8.89	SAM1160-07-ND	3.78	3.39	2.79
16	10.16	SAM1160-08-ND	3.91	3.50	2.88
18	11.43	SAM1160-09-ND	4.03	3.61	2.97
20	12.70	SAM1160-10-ND	4.15	3.72	3.06
22	13.97	SAM1160-11-ND	4.28	3.83	3.16
24	15.24	SAM1160-12-ND	4.4		