

Fig.	Description	Digi-Key Part No.	Price Each 1	10	Pomona Part No.
1	BNC Feed-Thru Termination, 50Ω	501-1036-ND	35.96	32.49	4119-50
2	BNC (Female) Isolated Ground Bulkhead Receptacle	501-1037-ND	3.24	2.93	3778
2	BNC (Female) Bulkhead Receptacle, Isolated Ground, PTFE, 75Ω	501-1151-ND	2.59	2.34	6741
2	BNC Female Bulkhead Receptacle, 75Ω	501-1153-ND	2.37	2.15	6745
3	Adapter, Isolated Ground BNC Female-Female	501-1038-ND	8.02	7.25	3846
3	Hermetic Sealed BNC Female-Female	501-1139-ND	19.82	17.91	3847
3	Isolated BNC Female to Female Panel	501-1142-ND	14.41	13.02	6705
3	BNC (Female-Female) Panel Mount, Hermetically Sealed, 75Ω	501-1152-ND	3.20	2.90	6744
4	BNC "T" (Male-Female-Female) Coaxial Adapter	501-1039-ND	13.74	12.42	4896
5	BNC Female Panel Receptacle	501-1040-ND	6.16	5.57	2451
5	BNC Female Panel Receptacle, 75Ω	501-1146-ND	2.71	2.45	6736
6	Adapter, Phono Jack to BNC Male	501-1096-ND	18.84	17.03	4054
7	Adapter, BNC Female to Phono Plug	501-1099-ND	6.92	6.26	5319
8	BNC Male to Dual BNC Female Straight Adapter	501-1100-ND	15.92	14.39	6700
9	BNC (Female) to Std. 1/4" Two Conductor Phone Plug	501-1128-ND	11.87	10.73	1297
10	BNC Female-Female	501-1132-ND	4.76	4.31	3283
10	BNC Female-Female, 75Ω	501-1147-ND	2.59	2.34	6737
11	BNC "T" (Female-Female-Female)	501-1133-ND	13.74	12.42	3284

Fig.	Description	Digi-Key Part No.	Price Each 1	10	Pomona Part No.
11	BNC (Female-Female-Female) 75Ω	501-1148-ND	3.67	3.32	6738
12	BNC "T" (Female-Male-Female)	501-1134-ND	6.06	5.48	3285
12	BNC (Female-Male-Female) 75Ω	501-1149-ND	3.67	3.32	6739
13	BNC Male-Male	501-1135-ND	3.24	2.93	3533
13	BNC Male-Male, 75Ω	501-1150-ND	2.06	1.86	6740
14	BNC (Female-Male) Right Angle	501-1136-ND	8.86	8.01	3534
15	SMA Female to BNC Male	501-1140-ND	9.00	8.13	4289
16	SMA Male to BNC Female	501-1141-ND	8.83	7.98	4290
17	BNC Female to Tini-Plug	501-1138-ND	14.29	12.92	3837
18	BNC Male Panel Mount, 75Ω	501-1145-ND	3.20	2.90	6735
19	BNC (Female-Male-Female) In-Line, 75Ω	501-1154-ND	3.67	3.32	6754
20	BNC (Male) / F (Female), 75Ω	501-1155-ND	3.45	3.12	6779
21	BNC (Female) / F (Female), 75Ω	501-1156-ND	3.45	3.12	6780
22	BNC (Female) / F (Male), 75Ω	501-1157-ND	3.45	3.12	6781
23	BNC (Male) / F (Male), 75Ω	501-1158-ND	3.45	3.12	6782
24	RCA (Female-Male-Female)	501-1161-ND	1.28	1.16	6882

◆ RoHS Compliant

Probes

Model 6723:

Features: • Test probe has a Stainless Steel sharp tip wit 8/32 threaded base • Alligator clip screws onto probe tip • Test leads fit all standard DMM with safety style banana jacks
Kit Includes: • A set of red and black test leads • A set of red and black medium alligator test clips

Model 6341:

Features: • Gold plated pogo pin tip keeps constant pressure on test point for consistent readings • Replaceable probe tips • Right angle DMM plug fits most digital multimeters
Kit Includes: • One red probe • One black probe with a set of all tip styles, which include: Sharp Point Gold Plated Pogo Pin Tip, Sharp Point Stainless Steel Tip, Triple Point Gold Plated Pogo Pin Tip, Quad Point Gold Plated Pogo Pin Tip and 3" (76.19mm) Long Sharp Point Stainless Steel Tip

Model 6731:

Features: • Allows user to safely make floating high voltage measurements while using general purpose oscilloscopes • Max. differential voltage up to 1000V • Differential amplifier converts and scales floating input signal to a low-voltage signal referenced to earth ground • The probe can be used on circuits associated with electronic high-power converters, motor speed controllers, switching power supplies, and other high voltage circuits requiring isolation • Switchable attenuation settings
Kit Includes: • Large Jaw Alligator Clips (one red and one black) • Pin-Grabber Test Clips (one red and one black) • 9V Alkaline Battery

Fig.	Description	Digi-Key Part No.	Price Each 1	10	Pomona Part No.
1	Model 6723, Test Lead Kit with 8/32 Threaded Probe Tip	501-1101-ND	35.54	32.12	6723
2	Model 6341, Replaceable Tip Precision Electronic Probe	501-1003-ND	36.79	33.24	6341
3	Model 6731, Active Differential Probe	501-1005-ND	625.21	564.95	6731
—	Power Adapter for Model 6731	501-1006-ND	108.32	97.88	6732

◆ RoHS Compliant

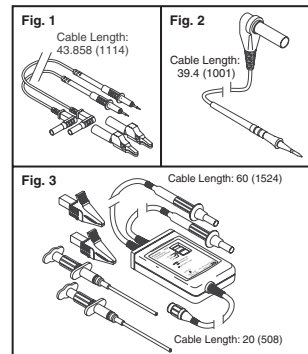

Test Enclosures

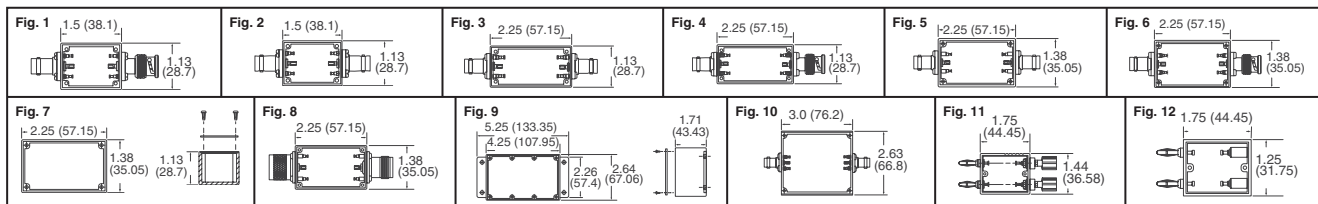

Fig.	Description	Digi-Key Part No.	Price Each 1	10	Pomona Part No.
Die Cast Aluminum - Blue					
1	Miniature Size Box, BNC Female to BNC Male with Cover	501-1103-ND	29.47	26.63	3752
2	Miniature Size Box, BNC Female/Female with Cover	501-1104-ND	31.31	28.29	3751
3	Size "A" Box, BNC Female/Female with Cover	501-1069-ND	26.54	23.99	2390
4	Size "A" Box, BNC Male/Female with Cover	501-1070-ND	28.92	26.13	2391
5	Size "B" Box, BNC Female/Female with Cover	501-1105-ND	25.35	22.91	3230
6	Size "B" Box, BNC Male/Female with Cover	501-1106-ND	30.44	27.51	3231
7	Size "B" Box Shield with Cover	501-1107-ND	8.45	7.64	2417

Fig.	Description	Digi-Key Part No.	Price Each 1	10	Pomona Part No.
8	Size "B" Box, Type N Male/Female with Cover	501-1112-ND	50.48	45.62	2411
9	Size "C" Box Shielded with Cover	501-1108-ND	20.53	18.56	2901
10	Size "D" Shielded Housing, BNC Female Both Ends with Cover	501-1111-ND	34.88	31.52	3602
Electrical Grade Phenolic - Black					
11	Box Component Mounting, Double Plug to Binding Posts w/Cover	501-1110-ND	28.70	25.94	2259
12	Box Component Mounting, Banana Jack to Double Plug w/Cover	501-1109-ND	18.96	17.13	2098

(Continued)

More Product Available Online: www.digikey.com

Toll-Free: 1-800-344-4539 • Phone 218-681-6674 • Fax: 218-681-3380

(T091) 2321



Test Leads



Kit Features: • Test leads with a right angle banana plug are ideal for use with hand held digital multimeter • Test accessories conveniently store in the four-fold nylon pouch • Compatible with most multimeters that accepts safety style sheath banana plugs • CE Compliant; complies with IEC 1010-2-031 standard for hand held accessories

Electrical DMM: Model 5673B — Kit Includes (1 red and 1 black of each): • Modular Probe Set • Extended Fine Point • Extra Large Alligator Clip Set • Medium Alligator Clip Set • Flexible Test Lead Set • Insulated Spade Lug Set **Model 5677B — Kit Includes (1 red and 1 black of each):** • Flexible Test Lead Set • Extra Large Alligator Clip Set • Test Lead Coupler Set • Retractable Tip Set • Spade Lug Adapter Set • IC Test Probe Tip Adapter Set • Minigrabber® Test Clip Set • 0.080 Replacement Probe Tip Set • Replacement Modular Test Probe Set • Minipincer® Test Clip Set • Medium Alligator Clip Set

SMD Multi-Use Test Kits: Model 72928 — Kit Includes: • (1 red and 1 black of each): • Micro SMD Grabber Test Clips • Mini-alligator clip with 2mm jack • SMD test probe, spring-set tip • Mini SMD Grabber Test Clips • 4mm plug/2mm plug adapter • Bench-top DMM test leads • SMD grabber clip lead • Stacking 2mm patch cords **Model 72935 — Kit Includes:** • 2 DMM Leads with 4mm Plugs • 2 Test Probes with Spring-Loaded Tips • 6 Micro SMD Grabbers • 6 Adapter Leads 0.8mm Female to 0.4mm Jack • 2 Mini SMD Grabbers with 4mm Connectors • 2 Holding Rods

Dimensions in Inches (mm)

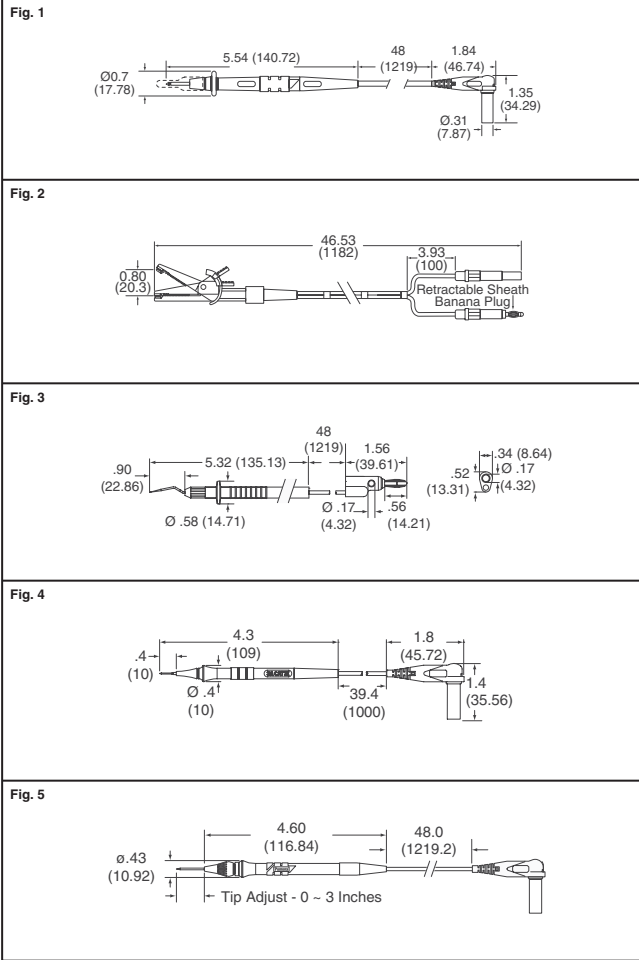

Oscilloscope Probes

Features: • All Probes meet IEC1010-2-031, 300V, CAT I **Probes Include:** • Retractable Hook Tip • BNC Adapter • IC Adapter • Insulating Tip • Trimmer Tool • 6" (152.40mm) Ground Lead with Alligator Clip

Probe Ratio	System Bandwidth MHz (-3db)	Cable Length Meters	Digi-Key Part No.	Price Each 1	10	Pomona Part No.
1:1 10:1	Up ~ 20 ³ 60	1.2	501-1012-ND	41.12	37.16	6266
1:1 10:1	Up ~ 15 ³ 100	1.2	501-1007-ND	58.88	53.21	4550B
1:1 10:1	Up ~ 20 ³ 200	1.2	501-1008-ND	67.40	60.90	5806A
100:1	200	2.0	501-1010-ND	108.32	97.88	5827A
10:1	250	1.2	501-1011-ND	62.52	56.49	6069A
10:1	300	1.2	501-1009-ND	114.81	103.74	5812A

◆ RoHS Compliant

Adapter Kits



Universal Adapter Kit (Model 5698) Includes:

- Type "N" Male and Female • BNC Male and Female • TNC Male and Female • SMA Male and Female • Coupling Adapter • Double Banana Plug • Double Binding Post

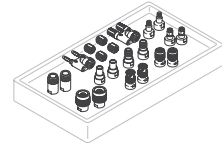

501-1034-ND \$184.16

Maxi Universal Adapter Kit (Model 5748) Includes:

- Type "N" Male and Female • BNC Male and Female • TNC Male and Female • SMA Male and Female • Coupling Nut • Double Banana Plug • UHF Male and Female • Mini UHF Male and Female • RCA Phono Male and Female • Type "F" Male and Female • Unidapt Signal Sampler

501-1035-ND \$297.95

7/16 DIN Type "N" Adapter Kit (Model 6254) Includes:

- Type "N" Male to DIN Male • Type "N" Female to DIN Male • Type "N" Male to DIN Female • Type "N" Female to DIN Female • DIN Female to Female • Right Angle Male to Female

501-1121-ND \$530.93

SMA Adapter Kit (Model 72931) Includes:

- Right Angle SMA Female to SMA Male • Inline SMA Male to SMA Male • Inline SMA Female to SMA Female • SMA Male Terminator Plug • SMA Female to BNC Male • SMA Male to BNC Female • SMA Female to BNC Female • SMA Male to TNC Male • SMA Female to TNC Male • SMA Male to TNC Female • SMA Female to TNC Female • SMA Male to Type "N" Male • SMA Female to Type "N" Male • SMA Male to Type "N" Female • SMA Female to Type "N" Female

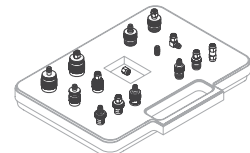

501-1235-ND \$252.44

N Adapter Kit (Model 72932) Includes:

- Type "N" Male to 50Ω BNC Female • Type "N" Female to 50Ω BNC Male • Inline Type "N" Female to Type "N" Female • Inline Type "N" Male to Type "N" Male • Right Angle Type "N" Female to Type "N" Male • Type "N" Male to SMA Male • Type "N" Male to SMA Female • Type "N" Female to SMA Male • Type "N" Female to SMA Female • T Style Type "N" Female to Type "N" Female to Type "N" Female • 50Ω Type "N" Terminator Plug • 75Ω Type "N" Terminator Plug

501-1236-ND \$309.87

Multi-RF Direct Adapter Kit (Model 72934) Includes:

- BNC Male to Type "N" Female • BNC Female to Type "N" Male • TNC Male to BNC Female • SMA Male to BNC Male • SMA Male to BNC Female • SMA Female to BNC Male • SMA Female to BNC Female • SMA Male to Type "N" Female • SMA Female to Type "N" Male • SMA Male to Type "N" Female • SMA Male to TNC Male • SMA Female to TNC Male • SMA Male to TNC Female • SMA Female to TNC Female • BNC Female to Female • BNC Male to Male • BNC Female to Male to Female TEE • BNC Female to Female to Female TEE • TNC Female to Female Adapter • Type "N" Female to Female • Type "N" Male to Male • SMA Male to Female Right Angle • SMA Male to Male • SMA Female to Female • SMA Termination, 50Ω Male

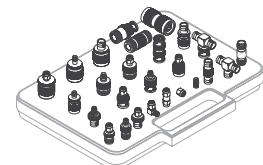

501-1238-ND \$388.97

Broadcast BNC Adapter Kit (Model 72933) Includes:

- 75Ω BNC Female to Female Adapter • 75Ω BNC Female to Female Adapter • 75Ω BNC Female to Male Adapter • 75Ω BNC Male to Male Adapter • BNC Female to Male to Female Adapter, In-Line, 75Ω • BNC Male to Female to Female, 75Ω • BNC Female to Female to Female, 75Ω • BNC Male to Female to Male, 75Ω • Adapter, BNC Female, Phono Plug • BNC Female to Tini Plug • Adapter, BNC Male, Phono Jack • BNC Female to Microplug • BNC Female to Phono Plug • BNC Male to Phono Jack Adapter • BNC Female to Bantam Plug • BNC Female to .090 Video Plug • BNC to Mini-WECCO Adapter • BNC Male Resistor Terminator Plug, 75Ω

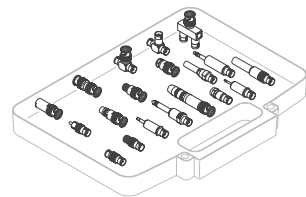

501-1237-ND \$238.34

Wire Test Leads



Description	Length (feet)	Color	Digi-Key Part No.	Price Each 1	10	100	Pomona Part No.
Model 6733 with Silicone Insulation	50	Black	501-1281-ND	19.94	18.02	17.18	6733-0
Model 6733 with Silicone Insulation	50	Red	501-1282-ND	19.94	18.02	17.18	6733-2

(Continued)

Fig.	Description	Digi-Key Part No.	Price Each 1	10	Pomona Part No.
1	IEC 1010 Compliant Replacement Test Leads for Sheathed Style DMM's, Includes: One Red and One Black	501-1004-ND	13.86	12.53	5519A
2	Wide Jaw Kelvin Lead Set, Includes: One Red and One Black	501-1102-ND	123.49	111.59	6730
3	SMD Test Probe Set, Includes: One Red and One Black	501-1246-ND	25.45	23.00	6235
4	Precision Electronic Probe with Replaceable Tip Includes: One Red and One Black	501-1248-ND	18.63	16.83	6275
5	Retractable Tip Test Probe Set, Sheathed DMM Plug	501-1249-ND	23.79	21.50	5953A

Kits

Electrical DMM					
—	Electrical DMM Test Lead Kit, Model 5673B	501-1002-ND	56.29	50.87	5673B
—	Deluxe Multi-use DMM Maxi-Test Lead Kit, Model 5677B	501-1000-ND	119.15	107.67	5677B

SMD Test Kits					
—	SMD Multi-Use Test Kit	501-1223-ND	137.07	123.86	72928
—	SMD High Density Circuit Test Kit	501-1239-ND	186.92	168.90	72935

More Product Available Online: www.digkey.com