

Round Aluminum Spacers (Non Threaded)

Materials: Brass: Nickel Plate (QQ-N-290)
Aluminum: Iridite Finish (MIL-C-5541)

Clearance Hole: • .120" for #4 Screw • .140" for #6 Screw • .171" for #8 Screw



Screw (Hole)	Dim. L (Inch)	Brass Spacers Part No.	Pricing		Aluminum Spacers Part No.	Pricing	
			10	100		10	100
#4 (.120)	.125	1909K-ND	3.64	35.80	2036K-ND	2.13	17.65
	.250	1454AK-ND	4.14	39.50	3457K-ND	2.49	20.05
	.375	1454BK-ND	4.87	42.65	3458K-ND	2.96	23.75
	.500	1454CK-ND	5.38	51.20	3459K-ND	3.23	25.75
	.625	1919K-ND	8.24	45.80	2314K-ND	3.57	29.70
	.750	1454DK-ND	7.08	57.40	3460K-ND	4.00	31.95
	.875	1920K-ND	7.47	71.80	3402K-ND	4.49	36.25
	1.000	1454EK-ND	9.52	92.05	3461K-ND	4.28	39.85
	1.500	1924K-ND	16.62	161.55	3462K-ND	11.03	85.75
	2.000	1925K-ND	22.03	214.10	3463K-ND	11.72	114.10
#6 (.140)	.125	1934K-ND	3.64	35.80	3403K-ND	2.13	17.65
	.250	1457AK-ND	4.14	39.50	3464K-ND	2.49	20.05
	.375	1457BK-ND	4.50	42.65	3465K-ND	2.96	23.75
	.500	1457CK-ND	5.28	51.20	3466K-ND	3.23	25.75
	.625	1935K-ND	6.08	56.70	3429K-ND	3.57	29.70
	.750	1457DK-ND	6.15	57.40	3467K-ND	4.00	31.95
	.875	1936K-ND	9.82	89.00	3438K-ND	4.49	36.25
	1.000	1457EK-ND	9.78	92.05	3468K-ND	4.28	39.85
	1.500	1937K-ND	16.62	161.55	3469K-ND	10.37	85.75
	2.000	1938K-ND	21.90	212.50	3470K-ND	11.72	114.10
#8 (.171)	.125	1942K-ND	3.64	35.80	4258K-ND	2.13	17.65
	.250	1480K-ND	4.14	39.50	3471K-ND	2.49	20.05
	.375	1481K-ND	4.41	42.65	3472K-ND	2.96	23.75
	.500	1482K-ND	5.28	51.20	3473K-ND	3.23	25.75
	.625	2032K-ND	5.89	56.70	4259K-ND	3.57	29.70
	.750	1483K-ND	5.98	57.40	3474K-ND	4.00	31.95
	.875	2033K-ND	9.82	89.00	4260K-ND	4.49	36.25
	1.000	1484K-ND	10.11	92.05	3475K-ND	4.28	39.85
	1.500	2034K-ND	16.62	161.55	3476K-ND	10.02	85.75
	2.000	2035K-ND	21.90	212.50	3477K-ND	11.72	114.10

◆ RoHS Compliant

Nylon Spacers

Hex Threaded Standoffs

Material: Nylon 6/6 Economical for terminal or printed circuit board supports.

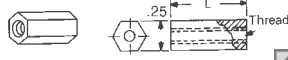

Dim. L (Inch)	4-40 Thread Part No.	6-32 Thread Part No.	8-32 Thread Part No.	Pricing	
				10	100
.250	1902AK-ND	1903AK-ND	1904AK-ND	5.40	49.05
.375	1902BK-ND	1903BK-ND	1904BK-ND	5.53	49.85
.500	1902CK-ND	1903CK-ND	1904CK-ND	5.76	52.55
.625	1902FK-ND	1903FK-ND	1904FK-ND	6.09	55.70
.750	1902DK-ND	1903DK-ND	1904DK-ND	7.40	67.05
.875	1902GK-ND	1903GK-ND	1904GK-ND	6.87	62.35
1.000	1902EK-ND	1903EK-ND	1904EK-ND	8.51	67.30

Hex Threaded Standoffs - Flame Retardant

Material: Monsanto 340 FR UL 94V-0 rating

Dim. L (Inch)	4-40 Thread Part No.	6-32 Thread Part No.	8-32 Thread Part No.	Pricing	
				10	100
.250	8440AK-ND	8441AK-ND	8442AK-ND	7.26	65.80
.375	8440BK-ND	8441BK-ND	8442BK-ND	7.42	67.30
.500	8440CK-ND	8441CK-ND	8442CK-ND	7.72	70.30
.625	8440DK-ND	8441DK-ND	8442DK-ND	9.20	83.35
.750	8440EK-ND	8441EK-ND	8442EK-ND	21.96	153.48
.875	8440FK-ND	8441FK-ND	8442FK-ND	8.97	86.30
1.000	8440GK-ND	8441GK-ND	8442GK-ND	9.99	90.80

◆ RoHS Compliant

Round Thru-Hole Spacers

Material: Nylon 6/6



Dim. L (Inch)	#4 Screw .120 Hole Part No.	#6 Screw .140 Hole Part No.	#8 Screw .171 Hole Part No.	Pricing	
				10	100
.125	875K-ND	883K-ND	891K-ND	1.41	12.25
.250	876K-ND	884K-ND	892K-ND	1.54	13.15
.375	877K-ND	885K-ND	893K-ND	1.83	16.75
.500	878K-ND	886K-ND	894K-ND	1.94	17.90
.625	879K-ND	887K-ND	895K-ND	2.09	19.35
.750	880K-ND	888K-ND	896K-ND	2.12	20.25
.875	881K-ND	889K-ND	897K-ND	2.41	23.20
1.000	882K-ND	890K-ND	898K-ND	2.55	24.30

Rubber Grommets



I.D. A (In.)	For Hole B (Inch)	For Panel C (Inch)	Dim. (Inch)		Digi-Key Part No.	Pricing		
			D	E		10	100	500
.125	.187	.062	.312	.187	730K-ND	1.26	12.25	41.50
.125	.250	.062	.343	.187	733K-ND	1.14	11.05	36.25
.125	.437	.062	.625	.187	734K-ND	12.51	116.35	375.50
.125	.375	.093	.500	.312	735K-ND	4.29	41.30	136.00
.187	.312	.062	.437	.218	736K-ND	1.38	13.50	43.75

I.D. A (In.)	For Hole B (Inch)	For Panel C (Inch)	Dim. (Inch)		Digi-Key Part No.	Pricing		
			D	E		10	100	500
.187	.312	.062	.437	.218	731K-ND	1.38	13.50	43.75
.187	.281	.093	.437	.218	737K-ND	3.30	31.60	105.50
.250	.437	.062	.625	.187	738K-ND	3.42	32.50	109.75
.250	.375	.062	.562	.250	739K-ND	1.74	17.00	55.25
.250	.375	.093	.500	.250	740K-ND	2.96	28.80	94.50
.312	.562	.062	.812	.312	741K-ND	6.15	59.20	196.00
.312	.437	.062	.625	.281	742K-ND	2.40	23.20	77.00
.312	.437	.093	.625	.312	743K-ND	3.67	35.80	117.75
.375	.625	.062	.875	.312	744K-ND	7.03	63.80	209.25
.375	.500	.062	.625	.250	745K-ND	1.89	18.35	60.75
.437	.687	.062	.937	.312	746K-ND	7.76	70.75	233.75
.500	.812	.062	1.062	.312	747K-ND	7.62	73.35	242.50
.500	1.250	.062	1.500	.25	748K-ND	9.29	89.10	294.50
.500	.750	.093	.968	.281	749K-ND	5.53	48.05	159.25
.562	.812	.062	1.062	.312	750K-ND	9.54	86.50	287.00
.625	.875	.062	1.125	.312	752K-ND	5.13	49.30	162.75
.625	1.250	.062	1.500	.250	753K-ND	14.33	130.05	428.00
.750	1.062	.062	1.375	.375	755K-ND	14.61	133.10	438.50
.750	1.437	.062	1.812	.375	756K-ND	33.32	313.00	1033.75
.875	1.250	.062	1.625	.437	757K-ND	21.03	202.95	669.00

◆ RoHS Compliant

Threaded Mounting Brackets

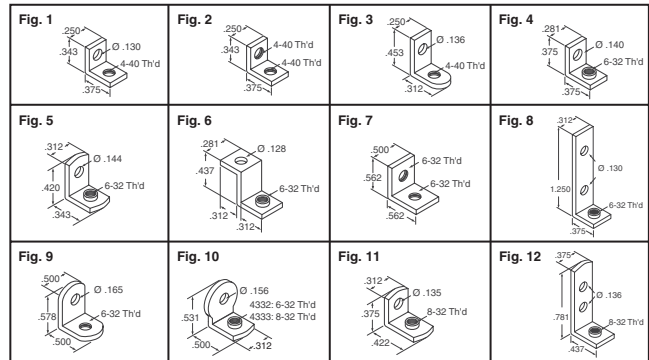
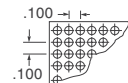

Fig.	Description	Digi-Key Part No.	Pricing	
			10	100
1	.062 Steel, Zinc Plate	612K-ND	2.19	20.05
2	.062 Steel, Zinc Plate	621K-ND	2.82	25.75
3	.047 Brass, Tin Plate	616K-ND	5.29	46.05
4	.032 Brass, Nickel Plate	634K-ND	4.60	37.45
5	.032 Brass, Tin Plate	614K-ND	2.51	24.30
6	.032 Brass, Tin Plate	630K-ND	12.99	101.15
7	.062 Steel, Nickel Plate	4334K-ND	6.03	48.60
8	.062 Steel, Nickel Plate	708K-ND	9.17	83.70
9	.062 Steel, Tin Plate	617K-ND	5.21	47.35
10	.062 Brass, Nickel Plate	4332K-ND	8.04	77.20
10	.062 Brass, Nickel Plate	4333K-ND	8.04	77.20
11	.037 Brass, Tin Plate	611K-ND	5.82	52.75
12	.037 Steel, Tin Plate	631K-ND	4.80	46.00

Prepunched Insulating Boards



Dimension - Inch Width	Inch Length	Digi-Key Part No.	Pricing		Keystone Part No.
			1	10	
Perfboard - Holes .042" (1.07mm) Dia., Glass Epoxy					
2.00	4.50	3405K-ND	5.22	48.72	3405
2.00	6.00	3406K-ND	6.81	63.56	3406
2.75	17.00	3407K-ND	20.40	190.40	3407
3.00	4.50	3408K-ND	7.11	66.36	3408
4.50	6.00	3409K-ND	9.96	92.96	3409
4.50	6.50	3410K-ND	11.52	107.52	3410
4.50	8.50	3411K-ND	14.28	132.60	3411
4.50	17.00	3412K-ND	27.99	261.24	3412
6.00	17.00	3413K-ND	37.68	351.68	3413

Miscellaneous Hardware



Description	Digi-Key Part No.	Pricing		Keystone Part No.
		1	10	
LED Spacer Mounts				
Universal Tri-Lead T-1 & T-1 3/4, 0.120"L	8900K-ND	.16	1.53	8900
Universal Tri-Lead T-1 & T-1 3/4, 0.440"L	8918K-ND	.19	1.83	8918
Self-Aligning Bi-Lead T-1, 0.140"L	7352K-ND	.16	1.53	7352
Self-Aligning Bi-Lead T-1 3/4, 0.250"L	8318K-ND	.17	1.59	8318
Self-Aligning Bi-Lead T-1 3/4, 0.340"L	8323K-ND	.18	1.65	8323
Spacers				
Aluminum Economy, #6 screw, 0.625"L	410K-ND	.13	1.27	410
Round, Swage Clear, #6 screw, 0.109"L	5064-2K-ND	.63	5.55	5064-2
Threaded Standoff				
Force-Fit, 4-40 Thread, 0.065"L	4861K-ND	.70	6.16	4861
Phenolic, 6-32 Thread, 0.750"L	386K-ND	.85	7.43	386
Round Swage, 2-56 Thread, 0.125"L	1589-2K-ND	.60	4.73	1589-2
Hex Swage, 6-32 Thread, 0.375"L	1622-2K-ND	.57	5.90	1622-2
PCI Computer Bracket	9203K-ND	2.15	19.80	9203K

More Product Available Online: www.digikey.com

Toll-Free: 1-800-344-4539 • Phone 218-681-6674 • Fax: 218-681-3380

(T091) 2279

Threaded Standoffs

- Brass: ASTM-B16
- Plating: Zinc (ASTM B633)
- Aluminum: QQ-A-225/3, Alloy 2011-T3
- Plating: Clear Iridite (Mil-C-5541)

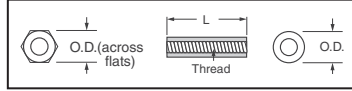

Note: Spacers over 1.000 long are tapped .375 deep each end.

Thread	O.D.	"L" Length (Inch)	Hex Thread Part No.	Pricing		Round Thread Part No.	Pricing	
				10	100		10	100
Aluminum								
2-56	.156	.187	1797AK-ND	6.74	61.30	1801AK-ND	5.96	57.15
		.250	1797BK-ND	7.24	65.60	1801BK-ND	5.89	56.50
		.312	1797CK-ND	7.53	68.30	1801CK-ND	6.38	61.30
		.375	1797DK-ND	7.30	70.30	1801DK-ND	7.84	71.20
4-40	.187	.250	1891K-ND	3.36	27.70	2025K-ND	3.33	25.75
		.375	1892K-ND	3.95	31.95	2026K-ND	3.85	30.60
		.500	1893K-ND	4.35	37.35	2027K-ND	4.24	36.70
		.625	1894K-ND	4.47	40.95	2028K-ND	4.39	39.15
		.750	1895K-ND	4.96	45.35	2029K-ND	4.89	42.20
		.875	1896K-ND	5.45	49.85	2030K-ND	5.35	47.35
		1.000	1897K-ND	7.26	65.80	2031K-ND	7.26	65.80
4-40	.250	.250	2201K-ND	3.25	26.65	3478K-ND	2.95	23.65
		.375	2202K-ND	3.64	29.70	3479K-ND	3.26	26.65
		.500	2203K-ND	4.03	32.50	3480K-ND	3.67	29.05
		.625	1808K-ND	4.34	36.25	1839K-ND	3.98	32.30
		.750	2204K-ND	4.29	38.95	3481K-ND	4.47	36.25
		.875	1809K-ND	5.58	53.55	1846K-ND	5.85	53.35
		1.000	2205K-ND	6.62	60.10	3482K-ND	6.46	58.95
		1.500	2206K-ND	11.28	102.25	3483K-ND	10.91	98.90
		2.000	2207K-ND	12.25	117.55	3484K-ND	11.90	114.40
		6-32	.250	.250	2208K-ND	3.25	26.65	3485K-ND
.375	2209K-ND			3.64	29.70	3486K-ND	3.26	26.65
.500	2210K-ND			4.03	32.50	3487K-ND	3.67	29.05
.625	1813K-ND			4.59	36.45	1847K-ND	4.36	42.20
.750	2211K-ND			4.29	38.95	3488K-ND	4.47	36.25
.875	1816K-ND			4.57	42.75	1848K-ND	4.30	39.15
1.000	2212K-ND			6.62	60.10	3489K-ND	6.46	58.95
1.250	1818K-ND			9.99	91.15	1853K-ND	9.79	88.75
1.500	2213K-ND			11.28	102.25	3490K-ND	10.91	98.90
1.750	1819K-ND			11.77	106.75	1855K-ND	10.90	104.85
2.000	2214K-ND			12.25	117.55	3491K-ND	11.90	114.40
2.250	1820K-ND			13.60	130.85	1856K-ND	14.07	127.90
2.500	1825K-ND			14.87	142.90	1857K-ND	14.51	140.05
8-32	.250	.250	2215K-ND	3.25	26.65	3492K-ND	2.95	23.65
		.375	2216K-ND	3.64	29.70	3493K-ND	3.26	26.65
		.500	2217K-ND	4.03	32.50	3494K-ND	3.67	29.05
		.625	1827K-ND	4.44	42.75	1858K-ND	3.98	32.30
		.750	2218K-ND	4.79	46.00	3495K-ND	4.47	36.25
		.875	1828K-ND	5.95	57.15	1859K-ND	4.33	39.15
		1.000	2219K-ND	6.62	60.10	3496K-ND	6.46	58.95
8-32	.375	1.500	2220K-ND	11.28	102.25	3497K-ND	10.44	98.90
		2.000	2221K-ND	12.25	117.55	3498K-ND	11.90	114.40
		.375	1926AK-ND	5.83	53.35	2315AK-ND	8.62	83.05
		.500	1926BK-ND	6.10	55.35	2315BK-ND	9.11	87.40
		.625	1926CK-ND	7.52	72.00	2315CK-ND	10.43	94.85
8-32	.750	1.000	1926DK-ND	9.28	84.50	2315DK-ND	11.19	101.80
8-32	1.000	1.000	1926EK-ND	10.60	102.60	2315EK-ND	12.56	121.30
Brass								
2-56	.156	.187	1798AK-ND	7.73	74.25	1802AK-ND	7.30	70.00
		.250	1798BK-ND	9.80	89.00	1802BK-ND	8.34	75.95
		.312	1798CK-ND	11.10	106.75	1802CK-ND	8.64	78.40
		.375	1798DK-ND	12.69	115.00	1802DK-ND	8.64	78.40
4-40	.187	.250	1450K-ND	4.67	26.90	1547K-ND	4.69	24.80
		.375	1803K-ND	5.47	44.20	1864K-ND	5.40	42.30
		.500	1656K-ND	5.61	51.75	1657K-ND	5.55	50.40
		.625	1804K-ND	6.82	61.65	1865K-ND	6.80	60.55
		.750	1656AK-ND	7.71	69.40	1657AK-ND	7.51	68.30
		.875	1805K-ND	9.46	86.75	1866K-ND	9.44	84.15
4-40	.250	1.000	1656BK-ND	9.94	90.90	1657BK-ND	9.86	89.35
		.250	1450AK-ND	4.36	34.90	1547AK-ND	5.02	48.40
		.375	1450BK-ND	5.46	43.10	1547BK-ND	5.88	56.70
		.500	1450CK-ND	5.52	51.55	1547CK-ND	7.17	68.85
		.625	1829K-ND	7.46	68.50	1867K-ND	8.60	78.40
		.750	1450DK-ND	8.53	80.10	1547DK-ND	9.63	87.85
		.875	1830K-ND	9.08	83.70	1876K-ND	10.85	98.35
		1.000	1450EK-ND	9.33	87.55	1547EK-ND	9.96	89.01
		1.500	1831K-ND	20.78	200.15	1877K-ND	20.29	194.30
		2.000	1832K-ND	21.30	205.00	1878K-ND	19.98	197.80
6-32	.250	.250	1451AK-ND	4.36	34.90	1548AK-ND	4.35	34.90
		.375	1451BK-ND	5.46	43.10	1548BK-ND	4.76	39.15
		.500	1451CK-ND	5.52	51.55	1548CK-ND	5.55	50.40
		.625	1451DK-ND	7.46	68.50	1548DK-ND	6.07	57.05
		.750	1451EK-ND	8.53	80.10	1548EK-ND	7.15	69.65
		.875	1833K-ND	9.08	83.70	1879K-ND	8.51	80.10
		1.000	1635K-ND	9.61	87.55	1548FK-ND	8.84	81.55
6-32	.250	1.250	1636K-ND	14.29	137.25	1881K-ND	14.90	135.25
		1.500	1637K-ND	17.56	159.20	1882K-ND	20.16	194.30
		1.750	1638K-ND	21.05	202.85	1883K-ND	20.42	196.75
		2.000	1639K-ND	21.30	205.00	1884K-ND	20.60	197.80

Thread	O.D.	"L" Length (Inch)	Hex Thread Part No.	Pricing		Round Thread Part No.	Pricing	
				10	100		10	100
6-32	.250	2.250	1642K-ND	21.73	209.60	1885K-ND	21.13	203.65
		2.500	1643K-ND	22.36	215.45	1886K-ND	21.73	209.60
8-32	.250	.250	1474AK-ND	4.36	34.90	1692AK-ND	6.01	57.40
		.375	1474BK-ND	5.46	43.10	1692BK-ND	6.69	60.85
		.500	1474CK-ND	5.52	51.55	1692CK-ND	8.52	77.40
		.625	1834K-ND	7.46	68.50	1877K-ND	9.75	88.55
		.750	1474DK-ND	8.53	80.10	1692DK-ND	11.55	104.85
		.875	1836K-ND	9.77	83.70	1888K-ND	11.05	100.35
		1.000	1474EK-ND	9.61	87.55	1692EK-ND	11.20	107.90
		1.500	1837K-ND	20.78	200.15	1889K-ND	20.16	194.30
		2.000	1838K-ND	21.30	205.00	1899K-ND	21.66	208.90
		8-32	.375	.375	1452AK-ND	9.84	84.15	1549AK-ND
.500	1452BK-ND			11.25	108.25	1549BK-ND	13.53	122.75
.625	1452CK-ND			14.62	140.20	1549CK-ND	14.23	135.25
.750	1452DK-ND			15.81	150.85	1549DK-ND	15.60	148.15
1.000	1452EK-ND			20.24	195.40	1549EK-ND	19.80	182.50

◆ RoHS Compliant

1/4" Hex Threaded Standoff Kit

Aluminum - Assortment of 1500 pieces in 1/4", 3/8", 1/2", 3/4" and 1" lengths with thread sizes of 4-40, 6-32 and 8-32. 100 pieces of each size complete with cabinet.

STH-22KIT-ND (RoHS Compliant) \$738.15

Male/Female .250" Hex Threaded Standoffs

- Brass: ASTM-B16
- Plating: Nickel (QQ-N-290)

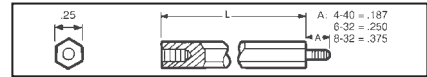

- Aluminum: QQ-Q-225/3
- Plating: Clear Iridite (Mil-C-5541)

Length (Inch)	4-40 Thread Part No.	Pricing		6-32 Thread Part No.	Pricing		8-32 Thread Part No.	Pricing	
		10	100		10	100		10	100
Aluminum									
.250	8714K-ND*	3.77	36.25	8717K-ND*	4.18	40.50	—	—	—
.375	8400K-ND†	4.28	41.30	8413K-ND†	4.43	42.65	8426K-ND†	5.87	56.25
.500	8401K-ND*	5.96	57.15	8414K-ND*	4.49	43.20	8427K-ND*	5.96	57.15
.625	8402K-ND*	6.42	61.65	8415K-ND*	5.66	54.95	8428K-ND*	6.42	61.65
.750	8403K-ND*	6.53	62.55	8416K-ND*	6.07	55.15	8429K-ND*	6.83	65.60
.875	8404K-ND*	7.09	68.05	8417K-ND*	6.61	60.10	8430K-ND*	8.07	73.15
1.000	8405K-ND*	7.49	71.80	8418K-ND*	6.53	62.55	8431K-ND*	8.05	77.20
1.125	8406K-ND*	9.18	88.30	8419K-ND*	6.73	64.70	8432K-ND*	11.48	104.30
1.250	8407K-ND*	9.86	89.35	8420K-ND*	7.19	68.85	8433K-ND*	11.89	108.10
1.375	8408K-ND*	11.55	104.75	8421K-ND*	8.67	78.55	8434K-ND*	12.84	116.65
1.500	8409K-ND*	11.82	107.20	8422K-ND*	9.33	89.55	8435K-ND*	12.97	117.55
1.625	8410K-ND*	11.44	110.05	8423K-ND*	10.07	91.35	8436K-ND*	13.10	118.90
1.750	8411K-ND*	12.43	112.95	8424K-ND*	10.56	95.85	8437K-ND*	13.24	120.15
2.000	8412K-ND*	12.84	116.65	8425K-ND*	10.14	97.30	8438K-ND*	13.38	121.30
Brass									
.250	8713K-ND*	5.43	51.75	8716K-ND*	5.30	51.20	—	—	—
.375	7200K-ND†	6.37	57.85	7210K-ND†	6.57	59.65	7220K-ND†	7.19	68.85
.500	1944K-ND*	7.82	75.25	1952K-ND*	6.75	64.90	1957K-ND*	7.26	69.65
.625	1945K-ND*	7.95	76.30	1953K-ND*	9.12	82.70	1958K-ND*	10.73	97.20
.750	1946K-ND*	9.47	90.90	1954K-ND*	9.58	86.85	1959K-ND*	10.60	101.95
.875	7201K-ND*	10.19	92.50						

Metric Hex Threaded Standoffs

- **Brass:** ASTM-B16
Plating: Nickel (QQ-N-290)
- **Aluminum:** ASTM B211
Plating: Clear Iridite (Mil-C-5541)
- **Nylon:** 6/6, UL Rated 94V-2

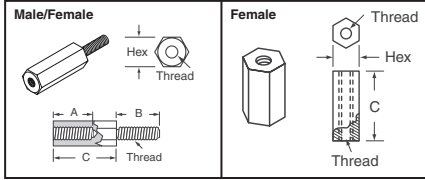

Dimensions – mm			Digi-Key Part No.	Pricing	
A	B	C		10	100
5mm Hex (M3 Thread)					
Brass - Male/Female					
8.0	8.0	10.0	24313K-ND	9.69	88.10
		12.0	24314K-ND	9.36	90.00
		15.0	24315K-ND	10.37	94.15
		18.0	24316K-ND	11.20	101.95
		20.0	24317K-ND	11.53	104.65
25.0	24318K-ND	11.96	115.00		
Brass - Female					
—	—	5.0	24390K-ND	6.36	57.85
		6.0	24391K-ND	5.21	49.50
		8.0	24392K-ND	6.80	65.15
		10.0	24393K-ND	6.09	55.35
		12.0	24394K-ND	6.01	57.70
		15.0	24395K-ND	7.90	75.95
		18.0	24396K-ND	6.90	67.05
		20.0	24397K-ND	9.89	90.00
25.0	24398K-ND	10.84	98.80		
Aluminum - Male/Female					
8.0	8.0	10.0	24337K-ND	4.08	39.40
		12.0	24338K-ND	5.68	54.45
		15.0	24339K-ND	6.12	58.75
		18.0	24340K-ND	6.22	59.50
		20.0	24341K-ND	6.75	64.80
25.0	24342K-ND	8.03	75.25		
Aluminum - Female					
—	—	5.0	24430K-ND	2.76	25.90
		6.0	24431K-ND	2.71	25.45
		8.0	24432K-ND	3.02	28.00
		10.0	24433K-ND	3.03	28.25
		12.0	24434K-ND	3.36	30.95
		15.0	24435K-ND	3.62	34.55
		18.0	24436K-ND	3.74	37.00
		20.0	24437K-ND	5.32	51.10
25.0	24438K-ND	5.93	57.15		
Nylon - Male/Female					
8.0	8.0	10.0	25501K-ND	4.27	41.40
		12.0	25502K-ND	4.45	42.85
		15.0	25503K-ND	4.53	43.65
		18.0	25504K-ND	4.62	44.45
		20.0	25505K-ND	4.71	45.70
25.0	25506K-ND	4.79	46.25		
Nylon - Female					
—	—	6.0	25508K-ND	4.70	46.80
		8.0	25509K-ND	5.00	49.50
		10.0	25510K-ND	4.81	47.35
		12.0	25511K-ND	5.01	49.95
		15.0	25512K-ND	5.46	53.00
		18.0	25513K-ND	6.44	63.90
		20.0	25514K-ND	6.15	59.40
		25.0	25515K-ND	6.48	64.15
6mm Hex (M4 Thread)					
Brass - Male/Female					
11.0	10.0	10.0	24325K-ND‡	5.53	53.00
		12.0	24326K-ND†	5.59	53.55
		15.0	24327K-ND	7.77	74.70
		18.0	24328K-ND	8.16	78.40
		20.0	24329K-ND	8.93	85.75
25.0	24330K-ND	9.37	90.10		
Brass - Female					
—	—	5.0	24410K-ND	2.99	27.35
		6.0	24411K-ND	2.93	26.90
		8.0	24412K-ND	3.43	31.50
		10.0	24413K-ND	3.36	33.20
		12.0	24414K-ND	4.25	39.60
		15.0	24415K-ND	6.56	61.65
		18.0	24416K-ND	6.98	64.35
		20.0	24417K-ND	6.56	61.65
25.0	24418K-ND	6.76	67.30		
Aluminum - Male/Female					
11.0	10.0	10.0	24349K-ND‡	5.59	53.55
		12.0	24350K-ND†	5.68	54.45
		15.0	24351K-ND	6.12	58.75
		18.0	24352K-ND	6.51	62.45
		20.0	24353K-ND	7.23	69.65
25.0	24354K-ND	7.67	73.45		
Aluminum - Female					
—	—	5.0	24450K-ND	2.76	25.90
		6.0	24451K-ND	2.71	25.45
		8.0	24452K-ND	3.02	28.00
		10.0	24453K-ND	3.03	28.25
		12.0	24454K-ND	3.36	30.95
		15.0	24455K-ND	4.23	40.75
		18.0	24456K-ND	4.56	43.90
		20.0	24457K-ND	5.67	54.45
25.0	24458K-ND	5.93	57.15		
Nylon - Male/Female					
9.5	9.5	10.0	25521K-ND	4.27	41.40
		12.0	25522K-ND	4.45	42.85

Dimensions – mm			Digi-Key Part No.	Pricing	
A	B	C		10	100
9.5	9.5	15.0	25523K-ND	4.53	43.65
		18.0	25524K-ND	4.62	44.45
		20.0	25525K-ND	4.71	45.70
		25.0	25526K-ND	4.79	46.25
Nylon - Female					
—	—	6.0	25528K-ND	4.70	46.80
		8.0	25529K-ND	5.00	49.30
		10.0	25530K-ND	4.81	47.35
		12.0	25531K-ND	5.01	49.95
		15.0	25532K-ND	5.46	53.00
		18.0	25533K-ND	6.44	63.90
		20.0	25534K-ND	6.15	59.40
25.0	25535K-ND	6.48	64.15		

‡ Internal Thread: 6.0mm deep † Internal Thread: 8.0mm deep
Note: Female Standoffs longer than 19mm are tapped from both ends

Metric Screws

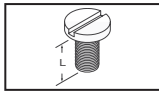

- **Steel:** Zinc Plate
- **Nylon:** 6/6, UL Rated 94V-2

Thread Size	Length – mm L	Digi-Key Part No.	Pricing	
			10	100
Steel				
M3	6	29311K-ND	3.06	28.90
	12	29314K-ND	3.18	29.95
	16	29316K-ND	3.50	32.95
	25	29318K-ND	3.61	34.00
M4	6	29321K-ND	3.29	30.95
	12	29324K-ND	3.42	32.20
	16	29326K-ND	4.02	37.80
	25	29328K-ND	4.48	42.20
Nylon				
M3	6	29341K-ND	1.55	15.10
	12	29344K-ND	1.60	15.55
	16	29346K-ND	1.61	15.65
	25	29348K-ND	1.64	15.85
M4	6	29351K-ND	1.70	16.55
	12	29354K-ND	1.73	16.75
	16	29356K-ND	1.74	16.90
	25	29358K-ND	1.76	17.00

Hinged Standoffs

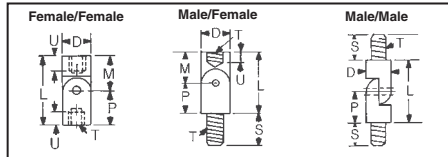

Thread T	Dia. – Inch D	Dimensions – Inch				Digi-Key Part No.	Pricing		
		L	S	U	M		P	10	100
Female/Female-Hinge									
4-40	.187	.750	—	.172	.375	.375	351K-ND	15.08	139.50
4-40	.187	1.000	—	.250	.375	.625	352K-ND	16.08	148.15
6-32	.250	.750	—	.172	.375	.375	353K-ND	21.51	198.55
6-32	.250	1.000	—	.250	.375	.625	354K-ND	21.97	203.50
8-32	.250	.750	—	.172	.375	.375	355K-ND	19.44	179.55
8-32	.250	1.000	—	.250	.375	.625	356K-ND	20.45	189.00
Male/Female-Hinge									
4-40	.187	.625	.250	.172	.375	.250	333K-ND	17.68	163.45
4-40	.187	.875	.250	.250	.625	.250	334K-ND	18.67	171.90
6-32	.250	.625	.312	.172	.375	.250	335K-ND	21.27	196.20
6-32	.250	.875	.312	.250	.625	.250	336K-ND	21.73	201.05
Male/Male-Hinge									
4-40	.187	.500	.250	—	—	.250	357K-ND	20.28	187.65
6-32	.250	.500	.312	—	—	.250	358K-ND	21.04	194.40
8-32	.250	.500	.312	—	—	.250	359K-ND	23.62	217.80

Ceramic Standoffs

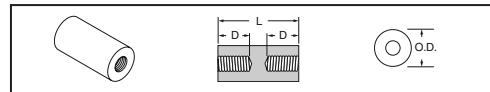

Thread Size	Diameter (Inch) O.D.	Length (Inch) L	Depth (Inch) D (2)	Digi-Key Part No.	Pricing	
					10	100
6-32	.250	.250	thru	7710K-ND◆	27.33	260.10
	.250	.500	.156	7711K-ND◆	31.08	290.95
	.375	.375	.156	7712K-ND	23.54	222.75
	.375	.500	.187	7713K-ND◆	26.64	252.70
	.500	.500	.140	7714K-ND	28.88	275.85
	.500	.750	.250	7715K-ND◆	30.33	290.95
	.500	1.000	.375	7716K-ND◆	32.52	306.10
	.500	1.500	.562	7717K-ND	38.43	367.20
	.500	2.500	.500	7718K-ND◆	49.55	467.20
	1/4-20	.750	2.500	.750	7719K-ND◆	69.05
.750		4.000	.750	7720K-ND	83.39	803.80

◆ RoHS Compliant

More Product Available Online: www.digkey.com

Toll-Free: 1-800-344-4539 • Phone 218-681-6674 • Fax: 218-681-3380