



Liquid Tight Grommet

Features:

- Provides dust and watertight seal
- Conforms to IP67 standards
- Provides light strain relief
- Fits a variety of cable sizes



Fig. 1

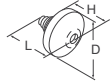

Fig. 2

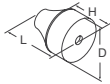
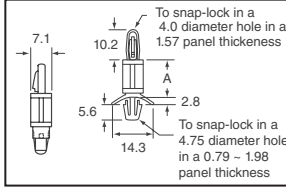

Fig.	Color	Material	Panel Hole (mm)	Panel Thick (mm)	Cable Size (mm)	Dimensions (mm)	Digi-Key Part No.	Price Each	Richco Part No.
						D L H		10 100	
1	Black	RMS-153	12.5	0.5-2.0	3.0-5.0	19.8 17.0 7.1	RP740-ND	.96 .80	LTG-199017
			16.0	1.0-4.0	5.0-7.0	21.0 18.9 6.2	RP741-ND	.62 .41	LTG-39897
			19.0	1.0-4.0	7.0-10.0	23.9 19.6 6.1	RP742-ND	.74 .49	LTG-34715
2	Gray	RMS-125	23.0	1.0-4.0	10.0-14.0	27.9 22.9 6.6	RP743-ND	.84 .56	LTG-34716
			29.0	1.0-4.0	14.0-20.0	35.8 24.4 6.6	RP744-ND	.99 .66	LTG-43021

Locking Circuit Board Supports

Features:

- Both ends lock by hand; no tools required
- Strong, dependable grip
- Material: Nylon 6/6
- Color: Natural



Dim. A (mm)	Digi-Key Part No.	Pricing				Richco Part No.
		10	100	500	1,000	
4.57	RP425-ND	2.39	19.92	79.66	119.49	LCBS-3
6.35	RP426-ND	2.54	21.19	84.76	127.14	LCBS-4
9.40	RP428-ND	2.67	22.25	89.00	133.50	LCBS-6
10.92	RP429-ND	2.78	23.15	92.58	138.87	LCBS-7
12.70	RP430-ND	2.87	23.93	95.72	143.58	LCBS-8
15.75	RP431-ND	3.07	25.60	102.38	153.57	LCBS-10
19.05	RP432-ND	3.27	27.29	109.16	163.74	LCBS-12
25.40	RP434-ND	3.68	30.69	122.74	184.11	LCBS-16

Wire Saddle

Features:

Wire Saddles are ideal for routing wires or optical fiber. Wires can be easily inserted into the top side of the saddle to protect them from abrasion. The **Micro** is ideal for low profile applications and takes up very little real estate. The **MOFNSA** is designed to snap into a .125" diameter hole in a .093" thick panel for applications that require a thicker board than the standard 1/16" board.

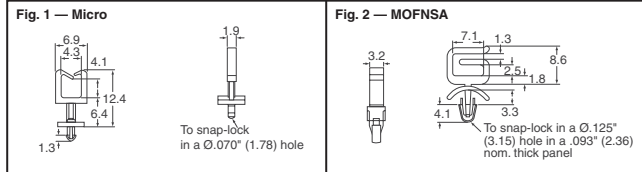

Hole Dia. Inch (mm)	Panel Thickness Inch (mm)	Digi-Key Part No.	Price Each	Richco Part No.
			10 100 500	
Fig. 1 — Standoff Micro Wire Saddle				
.070 (1.75)	.062 (1.57)	RP738-ND	.34 .29 .23	SMWS-1-01
.070 (1.75)	.093 (2.36)	RP739-ND	.34 .29 .23	SMWS-1-01
Fig. 2 — Mini Optical Fiber Network Saddle				
.125 (3.18)	.093 (2.36)	RP737-ND	.26 .22 .18	MOFNSA-2-01

Twist-Lok — TL Series

Features:

- Twist to secure wire bundles
- Material: Nylon 6/6, RMS-01
- Color: Natural

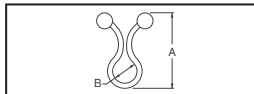

"A" Overall Height (mm)	"B" Wire Bundle Dia. (mm)	Digi-Key Part No.	25	Pricing	Richco Part No.
				100 1,000	
22.86	5.08 - 7.62	RP600-ND	2.88	9.88 59.29	TL-250
26.16	7.62 - 10.16	RP601-ND	3.08	10.57 63.43	TL-350
30.48	10.16 - 12.70	RP602-ND	3.32	11.39 68.36	TL-450
33.78	13.97 - 16.51	RP603-ND	3.47	11.89 71.35	TL-600
39.37	17.78 - 20.32	RP604-ND	4.03	13.82 82.94	TL-750
43.18	25.40 Maximum	RP605-ND	4.15	14.21 85.28	TL-950
55.63	30.23 Maximum	RP606-ND	5.61	19.25 115.49	TL-1125
68.07	36.58 Maximum	RP607-ND	6.68	22.91 137.45	TL-1375
74.42	39.62 Maximum	RP608-ND	8.29	28.43 170.60	TL-1500
87.63	45.97 Maximum	RP609-ND	8.80	30.16 180.94	TL-1750

Kurly-Lok On Base — KLB Series

Features:

- Adhesive backing, RMS-15
- Material: Nylon 6/6, RMS-01
- Color: Natural

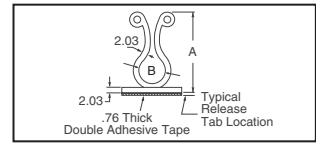

"A" Overall Height (mm)	"B" Wire Bundle Dia. (mm)	Digi-Key Part No.	25	Pricing	Richco Part No.
				100 1,000	
27.18	7.62 - 10.16	RP610-ND	13.02	44.63 267.80	KLB-350A-RT
31.24	10.16 - 12.70	RP611-ND	14.39	49.35 296.10	KLB-450A-RT
40.13	17.78 - 20.32	RP612-ND	15.13	51.86 311.18	KLB-750A-RT

Wire Cord Klip — WCK Series

Features:

- Adhesive backing for quick mounting
- Material: Nylon 6/6, RMS-01
- Color: Natural

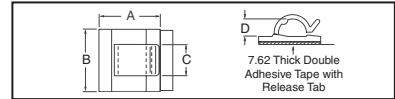

Hole Dia. (mm)	Dimensions (mm)				Digi-Key Part No.	Pricing			Richco Part No.
	A	B	C	D		25	100	1,000	
With Tape									
4.57	16.00	15.75	7.87	4.06	RP617-ND	14.40	49.37	296.21	WCK-180-01A-RT
11.43	25.15	25.15	11.94	7.11	RP618-ND	25.28	86.67	520.02	WCK-460-01A-RT
18.29	25.40	25.40	12.70	13.46	RP619-ND	31.43	107.77	646.60	WCK-720-01A-RT
Without Tape									
18.29	25.40	25.40	12.70	13.46	RP622-ND	24.97	85.62	513.72	WCK-720-01

Strain Relief Bushings — SRB-F and SRB-R Series

Features:

- Bushing eliminates strain and wear on wires and cords
- Withstands temperatures to 150°F (65°C)
- Material: Nylon 6/6, RMS-04
- Color: Black

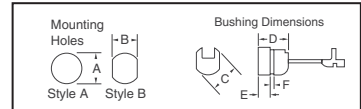

Digi-Key Part No.	Approx. Wire Size (mm)	Mounting Holes (mm)		Bushing Dimensions (mm)			
		Style A	Style B	C	D	E	F*
RP461-ND	2.79 x 5.33	9.52	8.76	10.79	10.41	3.94	1.57
	2.29 x 4.57						
RP462-ND	4.09 x 7.62	11.81	14.48	12.70	4.34	2.54	
	3.81 x 7.11						
RP463-ND	4.06 x 9.40	14.27	13.46	15.49	15.24	6.10	3.30
	3.81 x 8.64						
	5.08 x 9.40						
	4.57 x 8.89						
RP464-ND	4.83 x 7.62	12.70	11.58	13.84	10.19	3.61	1.80
	3.81 x 7.11						
	4.06 x 7.62						
RP465-ND	6.35	11.81	14.22	10.92	4.19	2.54	
	6.73						
	7.37						
	6.86						
RP466-ND	8.25	14.48	18.45	17.27	6.98	3.18	
	7.62						
	9.02						
	8.38						

* Maximum Panel Thickness

Digi-Key Part No.	Pricing				Richco Part No.
	25	100	1,000	5,000	
RP461-ND	10.54	36.12	216.72	174.58/M	SRB-F-2
RP462-ND	4.00	13.73	82.37	66.36/M	SRB-F-4
RP463-ND	13.35	45.78	274.68	221.27/M	SRB-F-5
RP464-ND	3.26	11.18	67.10	54.06/M	SRB-F-7
RP465-ND	3.64	12.49	74.92	60.35/M	SRB-R-5
RP466-ND	8.09	27.73	166.36	134.01/M	SRB-R-6
RPSRPL-ND	SRB Pincher Tool			\$99.25/1	SRPL-2

C-Type Flat Cable Clamps — CFCC Series

Features:

- Designed for routing flat ribbon cable
- Serrated grip to prevent slippage
- Adhesive backing for quick mount in any direction
- Material: Noryl-White, RMS-05; PVC-Gray, RMS-04

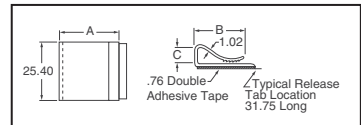

Material	Dimensions (mm)			Digi-Key Part No.	Pricing			Richco Part No.
	A	B	C		25	100	1,000	
Noryl-White	14.27	12.45	4.57	RP391-ND	12.86	44.09	264.56	CFCC-3-05A-RT
	14.27	10.16	6.35	RP392-ND	16.32	55.96	335.74	CFCC-4-05A-RT
	26.97	22.35	6.35	RP393-ND	20.37	69.83	418.97	CFCC-8-05A-RT
Rigid PVC-Gray	26.97	22.35	6.35	RP394-ND	15.71	53.86	323.17	CFCC-8-04A-RT

More Product Available Online: www.digkey.com

Richco Cable Clamps — N Series

- Features:**
 • Material: Nylon 6/6, RMS-01
 • Colors: Natural and Black

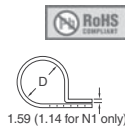
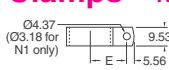

Description	Dimensions (mm)		Digi-Key Part No.	Pricing			Richco Part No.
	D	E		25	100	1,000	
Black, RMS-49	1.60	6.86	RP322-ND	1.80	6.16	36.94	N-1-BK
	3.18	8.33	RP323-ND	1.83	6.28	37.69	N-2-BK
	4.78	9.91	RP324-ND	2.10	7.21	43.24	N-3-BK
	6.35	10.69	RP325-ND	2.19	7.49	44.96	N-4-BK
	7.95	11.51	RP326-ND	2.21	7.58	45.47	N-5-BK
	9.52	12.29	RP327-ND	2.40	8.22	49.32	N-6-BK
	11.13	11.99	RP328-ND	2.49	8.53	51.19	N-7-BK
	12.70	14.27	RP329-ND	2.52	8.63	51.77	N-8-BK
Natural, RMS-01	1.60	6.86	RP314-ND	2.00	6.85	41.08	N-1
	3.18	8.33	RP315-ND	2.04	6.98	41.90	N-2
	4.78	9.91	RP316-ND	2.33	8.00	48.02	N-3
	6.35	10.69	RP317-ND	2.43	8.32	49.90	N-4
	7.95	11.51	RP318-ND	2.46	8.42	50.54	N-5
	9.52	12.29	RP319-ND	2.67	9.14	54.83	N-6
	11.13	11.99	RP320-ND	2.77	9.48	56.88	N-7
	12.70	14.27	RP321-ND	2.79	9.58	57.49	N-8

Hanking Ties

- Features:**
 • Wrap electrical cords for shipping and packaging
 • Material: Polyethylene
 • Color: Natural

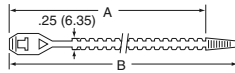

Max. Bundle Diameter (mm)	Dimensions (mm)		Digi-Key Part No.	Price Per Package		Richco Part No.
	A	B		100	1,000	
.9 (22.86)	3.2 (81.28)	3.9 (99.06)	RP701-ND	23.13	138.78	HT-3.9
1.4 (35.56)	5.2 (132.08)	5.9 (149.86)	RP703-ND	29.06	174.38	HT-5.9

• RoHS Compliant

Wrap-It-Ties

- Features:**
 • Easy to use permanent lock
 • Strong, one-piece construction
 • Serviceable to 185°F (85°C)
 • UL recognized #E71558



RPWTA-ND \$13.59

RPWTD-ND \$59.40

† Replace □ with "C" for package of 100, "M" for package of 1,000.

Max. Bundle Diameter (in.)	Approx. Length (in.)	Min. Loop Tensile Strength (lbs.)	Approx. Width (in.)	Color	Digi-Key Part No.†	Package Size			Richco Part No.
						Price Per Pkg. C = 100	Price Per Pkg. M = 1,000		
Nylon 6/6									
0.6	3.25	18	.10	Natural	RP101□-ND	2.89	16.52		WIT-18SF
0.6	3.25	18	.10	Red	RP101RD-ND	—	18.07		WIT-18SF-RD
0.7	4.5	18	.10	Natural	RP102□-ND	3.22	18.36		WIT-18R
0.7	4.5	18	.10	Blue	RP102BL□-ND	3.29	18.76		WIT-18R-BL
0.7	4.5	18	.10	Green	RP102GN□-ND	4.89	18.76		WIT-18R-GN
0.7	4.5	18	.10	Red	RP102RD□-ND	3.29	18.76		WIT-18R-RD
0.7	4.5	18	.10	Yellow	RP102YL□-ND	3.29	18.76		WIT-18R-YL
1.3	5.75	18	.10	Natural	RP213□-ND	3.86	22.03		WIT-18L
2.1	8.0	18	.10	Natural	RP103□-ND	5.01	28.66		WIT-18V
1.2	5.75	30	.14	Natural	RP104□-ND	6.04	34.52		WIT-30R
1.2	5.75	30	.14	Blue	RP104BL□-ND	—	35.24		WIT-30R-BL
1.2	5.75	30	.14	Green	RP104GN□-ND	9.00	35.24		WIT-30R-GN
1.2	5.75	30	.14	Red	RP104RD□-ND	5.87	35.24		WIT-30R-RD
1.2	5.75	30	.14	Yellow	RP104YL□-ND	6.17	35.24		WIT-30R-YL
1.8	7.3	30	.14	Natural	RP105□-ND	6.49	37.08		WIT-30L
1.8	7.3	30	.14	Green	RP105GN□-ND	9.62	—		WIT-30L-GN
1.8	7.3	30	.14	Yellow	RP105YL□-ND	7.16	—		WIT-30L-YL
0.7	4.5	40	.14	Natural	RP214□-ND	5.98	34.74		WIT-40S
1.2	5.75	40	.14	Natural	RP106□-ND	7.01	40.03		WIT-40R
1.2	5.75	40	.14	Blue	RP106BL□-ND	7.70	39.10		WIT-40R-BL
1.2	5.75	40	.14	Green	RP106GN□-ND	—	39.10		WIT-40R-GN
1.2	5.75	40	.14	Yellow	RP106YL□-ND	7.70	35.60		WIT-40R-YL
1.8	7.3	40	.14	Natural	RP107□-ND	8.74	49.93		WIT-40L
1.8	7.3	40	.14	Green	RP107GN□-ND	9.59	48.71		WIT-40L-GN
1.8	7.3	40	.14	Red	RP107RD□-ND	9.59	48.71		WIT-40L-RD
3.1	11.1	40	.15	Natural	RP215□-ND	15.17	86.65		WIT-40VL
1.5	6.0	50	.19	Natural	RP108□-ND	7.13	40.75		WIT-50S
1.5	6.0	50	.19	Red	RP108RD□-ND	7.84	—		WIT-50S-RD
1.5	6.0	50	.19	Yellow	RP108YL□-ND	10.69	—		WIT-50S-YL
2.0	8.0	50	.19	Natural	RP109□-ND	8.09	46.26		WIT-50R
2.0	8.0	50	.19	Blue	RP109BL□-ND	8.44	48.20		WIT-50R-BL
2.0	8.0	50	.19	Green	RP109GN□-ND	8.44	48.20		WIT-50R-GN
2.0	8.0	50	.19	Red	RP109RD□-ND	12.31	48.20		WIT-50R-RD
2.0	8.0	50	.19	Yellow	RP109YL□-ND	8.44	48.20		WIT-50R-YL
4.5	15.3	50	.18	Natural	RP110□-ND	14.46	82.62		WIT-50L
2.7	10.7	60	.18	Natural	RP216□-ND	12.47	71.24		WIT-60R
4.2	15.06	120	.30	Natural	RP111□-ND	39.43	—		WIT-120R-C
UV Stabilized Nylon 6/6 - Exterior or Outdoor Use									
0.6	3.25	18	.10	Black	RP201□-ND	3.22	18.36		WIT-18SF-UVB
0.7	4.5	18	.10	Black	RP202□-ND	3.53	20.20		WIT-18R-UVB
1.1	8.0	18	.10	Black	RP203M-ND	—	31.21		WIT-18V-UVB
2.1	5.75	30	.14	Black	RP204□-ND	6.68	38.20		WIT-30R-UVB
1.8	7.3	30	.14	Black	RP205□-ND	7.20	41.11		WIT-30L-UVB
1.2	5.75	40	.14	Black	RP206□-ND	8.24	44.06		WIT-40R-UVB
1.8	7.3	40	.14	Black	RP207□-ND	9.58	54.72		WIT-40L-UVB
1.5	6.0	50	.19	Black	RP208□-ND	7.84	44.78		WIT-50S-UVB
2.0	8.0	50	.19	Black	RP209□-ND	8.93	51.05		WIT-50R-UVB

Max. Bundle Diameter (in.)	Approx. Length (in.)	Min. Loop Tensile Strength (lbs.)	Approx. Width (in.)	Color	Digi-Key Part No.	Package Size		Richco Part No.	
						Price Per Pkg. C = 100	Price Per Pkg. M = 1,000		
4.5	15.3	50	.18	Black	RP210□-ND	15.94	91.08	WIT-50L-UVB	
4.2	15.06	120	.30	Black	RP211C-ND	37.08	—	WIT-120R-UVB	
Nylon 6/6, Size 10 — Screw Mount									
1.5	6.75	50	.19	Natural	RP224M-ND	—	94.00	WITSH-10-50MS	
2	8.69	50	.19	Natural	RP225M-ND	—	109.08	WITSH-10-50MRL	
3	11.25	50	.19	Natural	RP226M-ND	—	112.36	WITSH-10-50MR	
Nylon 6/6, Release Tab									
1.25	5.5	40	.21	Natural	RP217M-ND	—	87.98	WIT-RT-0550	
2	8.0	40	.21	Natural	RP218□-ND	16.97	96.98	WIT-RT-0800	
2.5	10.5	40	.21	Natural	RP219□-ND	29.75	146.59	WIT-RT-1050	

Max. Bundle Diameter (in.)	Approx. Length (in.)	Min. Loop Tensile Strength (lbs.)	Approx. Width (in.)	Color	Digi-Key Part No.	Pricing		Richco Part No.
						25	100	
Nylon 6/6, Release Tab (Large Size)								
4	15.25	250	.52	Natural	RP221-ND	40.41	138.56	WIT-RT-1525
6	21.5	250	.52	Natural	RP222-ND	46.20	158.39	WIT-RT-2150
8	27.75	250	.52	Natural	RP223-ND	54.32	186.24	WIT-RT-2775

Beaded Ties

- Features:** • Easy to install and release • Material: Nylon 6/6 • Color: Natural

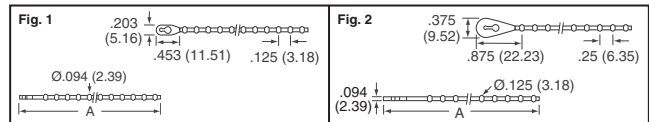
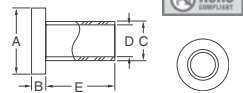

Fig.	Dim "A" (approx.) Inch (mm)	Digi-Key Part No.	Price Per Package		Richco Part No.
			100	1,000	
1	4.0 (101.60)	RP731-ND	9.19	55.15	BT-4-01-NT
	6.0 (152.40)	RP733-ND	16.06	96.34	BT-6-01-NT
2	8.75 (222.25)	RP734-ND	22.24	133.45	BT-8-01-NT
	10.75 (273.05)	RP735-ND	27.76	166.54	BT-10-01-NT
	12.75 (323.85)	RP736-ND	31.67	190.01	BT-12-01-NT

Molded Nylon Insulators — MNI Series

- Features:** • Use as screw insulators and in many bushing applications
 • Lightweight • High dielectric strength • Resistant to corrosion and abrasion • Material: Nylon 6/6, RMS-48 • Color: Natural



Max. Bundle Diameter (in.)	Approx. Length (in.)	Min. Loop Tensile Strength (lbs.)	Approx. Width (in.)	Color	Digi-Key Part No.†	Package Size			Richco Part No.		
						Price Per Pkg. C = 100	Price Per Pkg. M = 1,000				
Nylon 6/6											
#2	M2.2	.181	.047	.120	.090	.031	RP330-ND	6.07	20.80	124.81	MNI#2-2
#4	M3	.235	.047	.145	.115	.031	RP337-ND	6.07	20.80	124.81	MNI#4-2
		.252	.047	.140	.115	.046	RP338-ND	6.07	20.80	124.81	MNI#4-3
		.235	.047	.145	.115	.063	RP339-ND	6.07	20.80	124.81	MNI#4-4
		.252	.047	.140	.115	.084	RP340-ND	6.07	20.80	124.81	MNI#4-5
		.252	.047	.140	.115	.093	RP341-ND	6.07	20.80	124.81	MNI#4-6
		.235	.047	.145	.115	.125	RP342-ND	6.07	20.80	124.81	MNI#4-8
#5	M3	.252	.047	.140	.115	.156	RP343-ND	6.07	20.80	124.81	MNI#4-10
		.235	.047	.145	.115	.187	RP344-ND	6.07	20.80	124.81	MNI#4-12
		.252	.047	.140	.115	.250	RP345-ND	6.07	20.80	124.81	MNI#4-16
		.235	.047	.145	.115	.375	RP346-ND	6.07	20.80	124.81	MNI#4-24
		.370	.050	.236	.126	.050	RP347-ND	7.28	24.97	149.83	MNI#5-3
		.290	.047	.170	.140	.031	RP348-ND	6.08	20.84	125.03	MNI#6-2
#6	M3.5	.290	.047	.170	.140	.093	RP350-ND	6.08	20.84	125.03	MNI#6-6
		.290	.047	.170	.140	.125	RP351-ND	6.08	20.84	125.03	MNI#6-8
		.290	.047	.170	.140	.187	RP35				

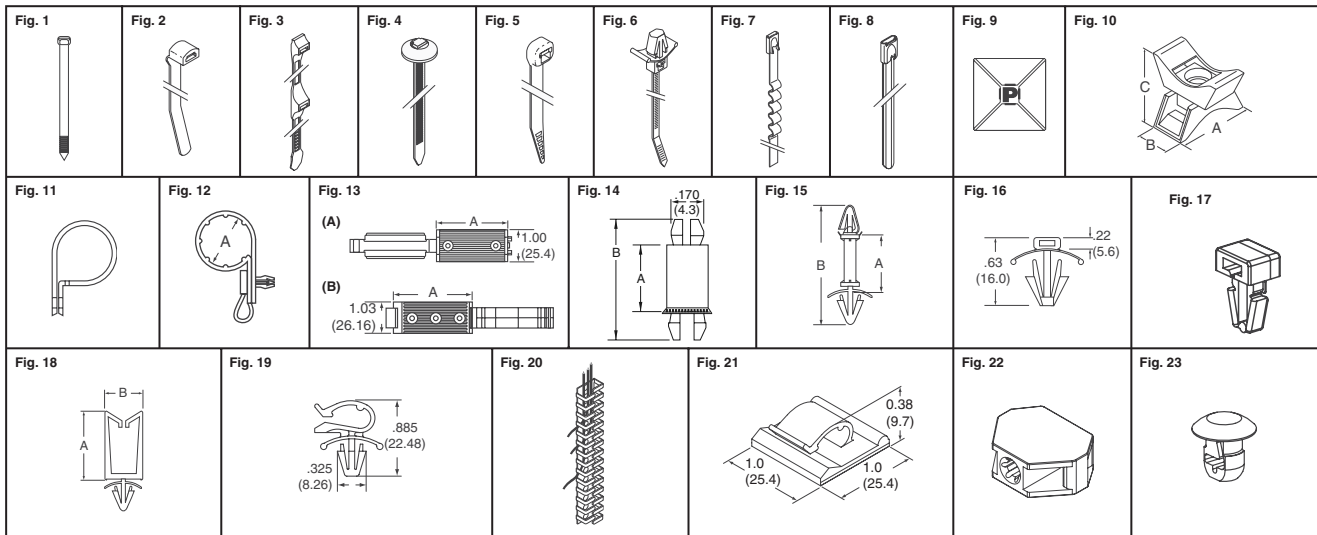

Fig.	Min. Loop Tensile Strength (Lbs)	Length Inch (mm)	Width Inch (mm)	Max. Bundle Diameter Inch (mm)	Digi-Key Part No.	Pkg. Qty.	Price/Pkg.	Panduit Part No.	
PAN-TY® Clamp Tie With Mounting Hole - Nylon - RoHS Compliant									
1	18	4.3 (109.2)	0.100 (2.5)	0.75 (19.1)	298-1000-ND	100	34.03	PLC1M-S4-C	
	40	6.1 (154.9)	0.135 (3.4)	1.25 (31.8)	298-1001-ND	100	34.21	PLC1.5I-S8-C	
	50	7.9 (200.7)	0.190 (4.8)	1.84 (46.7)	298-1002-ND	100	36.20	PLC2S-S10-C	
	50	12.0 (304.8)	0.190 (4.8)	3.00 (76.2)	298-1003-ND	100	83.59	PLC3S-S10-C	
	50	15.0 (381.0)	0.190 (4.8)	4.00 (101.6)	298-1004-ND	100	94.50	PLC4S-S10-C	
PAN-TY Clamp Tie With Mounting Hole - Weather Resistant - Black - RoHS Compliant									
1	18	4.3 (109.2)	0.100 (2.5)	0.75 (19.1)	298-1005-ND	100	60.61	PLC1M-S4-C0	
	40	6.1 (154.9)	0.135 (3.4)	1.25 (31.8)	298-1006-ND	100	43.67	PLC1.5I-S8-C0	
	50	7.9 (200.7)	0.190 (4.8)	1.84 (46.7)	298-1007-ND	100	45.46	PLC2S-S10-C0	
	50	12.0 (304.8)	0.190 (4.8)	3.00 (76.2)	298-1008-ND	100	96.91	PLC3S-S10-C0	
	50	15.0 (381.0)	0.190 (4.8)	4.00 (101.6)	298-1009-ND	100	109.28	PLC4S-S10-C0	
PAN-TY Locking Clamp Tie - Nylon - RoHS Compliant									
1	50	7.9 (200.7)	.190 (4.8)	1.84 (47)	298-9973-ND	100	45.46	PLC2S-S6-C0	
PAN-TY Cable Tie - Nylon - RoHS Compliant									
1	12	2.8 (71.1)	0.070 (1.8)	0.60 (15.2)	298-1016-ND	100	13.64	PLT6SM-C	
	12	2.8 (71.1)	0.070 (1.8)	0.60 (15.2)	298-1017-ND	1,000	28.38	PLT6SM-M	
	18	3.1 (78.7)	0.090 (2.3)	0.68 (17.3)	298-1018-ND	100	14.27	PLT7M-C	
	18	3.1 (78.7)	0.090 (2.3)	0.68 (17.3)	298-1019-ND	1,000	26.99	PLT7M-M	
	18	3.9 (99.1)	0.098 (2.5)	0.87 (22.1)	298-1020-ND	100	15.35	PLT1M-C	
	18	3.9 (99.1)	0.098 (2.5)	0.87 (22.1)	298-1021-ND	1,000	30.83	PLT1M-M	
	40	5.6 (142.2)	0.142 (3.6)	1.38 (35.1)	298-1022-ND	100	17.78	PLT1.5I-C	
	40	5.6 (142.2)	0.142 (3.6)	1.38 (35.1)	298-1023-ND	1,000	47.57	PLT1.5I-M	
	18	5.6 (142.2)	0.098 (2.5)	1.25 (31.8)	298-1024-ND	100	19.99	PLT1.5M-C	
	18	5.6 (142.2)	0.098 (2.5)	1.25 (31.8)	298-1025-ND	1,000	46.55	PLT1.5M-M	
	50	7.4 (188.0)	0.190 (4.8)	1.88 (47.8)	298-1030-ND	100	22.67	PLT2S-C	
	50	7.4 (188.0)	0.190 (4.8)	1.88 (47.8)	298-1031-ND	1,000	65.06	PLT2S-M	
	40	8.0 (203.2)	0.142 (3.6)	2.00 (50.8)	298-1026-ND	100	27.05	PLT2I-C	
	40	8.0 (203.2)	0.142 (3.6)	2.00 (50.8)	298-1027-ND	1,000	61.85	PLT2I-M	
	18	8.0 (203.2)	0.098 (2.5)	2.00 (50.8)	298-1028-ND	100	21.37	PLT2M-C	
	18	8.0 (203.2)	0.098 (2.5)	2.00 (50.8)	298-1029-ND	1,000	47.25	PLT2M-M	
	40	11.4 (289.6)	0.145 (3.7)	3.00 (76.2)	298-1032-ND	100	33.03	PLT3I-C	
	50	11.5 (292.1)	0.190 (4.8)	3.00 (76.2)	298-1033-ND	100	45.33	PLT3S-C	
	50	11.5 (292.1)	0.190 (4.8)	3.00 (76.2)	298-1034-ND	1,000	169.31	PLT3S-M	
	50	14.5 (368.3)	0.190 (4.8)	4.00 (101.6)	298-1035-ND	100	51.60	PLT4S-C	
	50	14.5 (368.3)	0.190 (4.8)	4.00 (101.6)	298-1036-ND	1,000	189.20	PLT4S-M	
	50	17.5 (445.0)	0.190 (4.8)	5.00 (127.0)	298-1360-ND	100	77.42	PLT5S-C	
	50	17.5 (445.0)	0.190 (4.8)	5.00 (127.0)	298-1361-ND	1,000	267.69	PLT5S-M	
	120	21.9 (556.0)	0.300 (7.6)	6.00 (152.0)	298-1366-ND	100	76.68	PLT6LH-L	
	120	21.9 (556.0)	0.300 (7.6)	6.00 (152.0)	298-1367-ND	100	59.69	PLT6LH-C	
	120	24.7 (627.0)	0.300 (7.6)	7.00 (178.0)	298-1368-ND	50	65.15	PLT7LH-L	
	120	24.7 (627.0)	0.300 (7.6)	7.00 (178.0)	298-1369-ND	50	50.94	PLT7LH-C	
	120	27.6 (701.0)	0.300 (7.6)	8.00 (203.0)	298-1373-ND	100	124.40	PLT8LH-C	
	PAN-TY Cable Tie High Temperature - Poly - RoHS Compliant								
	1	150	7.4 (188)	.190 (4.8)	1.88 (48)	298-9956-ND	1,000	1103.70	PLT2S-M71
	CONTOUR-TY™ Cable Tie - Nylon - RoHS Compliant								
	2	18	4.1 (104)	0.100 (2.5)	1.00 (25.4)	298-9908-ND	1,000	35.46	CBR1M-M
		40	5.9 (150)	0.140 (3.6)	1.50 (38.1)	298-9904-ND	1,000	54.74	CBR1.5I-M
		18	7.2 (183)	0.100 (2.5)	2.00 (50.8)	298-9912-ND	1,000	54.38	CBR2M-M
		50	7.6 (193)	0.190 (4.8)	2.00 (50.8)	298-9914-ND	1,000	74.78	CBR2S-M

Fig.	Min. Loop Tensile Strength (Lbs)	Length Inch (mm)	Width Inch (mm)	Max. Bundle Diameter Inch (mm)	Digi-Key Part No.	Pkg. Qty.	Price/Pkg.	Panduit Part No.	
2	85	8.0 (203)	0.250 (6.4)	2.00 (50.8)	298-9910-ND	500	147.34	CBR2HS-D	
	40	10.4 (264)	0.140 (3.6)	3.00 (76.2)	298-9916-ND	1,000	149.88	CBR3I-M	
	50	10.8 (274)	0.190 (4.8)	3.00 (76.2)	298-9918-ND	1,000	194.81	CBR3S-M	
	120	20.9 (531)	0.300 (7.6)	6.00 (152.4)	298-9926-ND	100	97.59	CBR6LH-C	
Double Hose Clamp - Nylon - RoHS Compliant									
3	100	11.0 (279)	.280 (7.1)	1.12 (28.4)†	298-9962-ND	50	64.86	DHC1.12X1.75-DO	
CONTOUR-TY Cable Tie - Weather Resistant - Black - RoHS Compliant									
2	18	4.1 (104)	0.100 (2.5)	1.00 (25.4)	298-9909-ND	1,000	55.55	CBR1M-M0	
	18	5.6 (142)	0.100 (2.5)	1.50 (38.1)	298-9907-ND	1,000	76.91	CBR1.5M-M0	
	40	5.9 (150)	0.140 (3.6)	1.50 (38.1)	298-9905-ND	1,000	73.94	CBR1.5I-M0	
	18	7.2 (183)	0.100 (2.5)	2.00 (50.8)	298-9913-ND	1,000	80.34	CBR2M-M0	
	50	7.6 (193)	0.190 (4.8)	2.00 (50.8)	298-9915-ND	1,000	83.51	CBR2S-M0	
	50	10.8 (274)	0.190 (4.8)	3.00 (76.2)	298-9919-ND	1,000	231.48	CBR3S-M0	
	40	13.6 (345)	0.140 (3.6)	4.00 (101.6)	298-9921-ND	1,000	309.35	CBR4I-M0	
	50	14.0 (356)	0.190 (4.8)	4.00 (101.6)	298-9925-ND	1,000	245.81	CBR4S-M0	
120	20.9 (531)	0.300 (7.6)	6.00 (152.4)	298-9927-ND	100	118.90	CBR6LH-C0		
STA-STRAP® Panel Mount Tie - Nylon - RoHS Compliant									
4	120	10.1 (257)	.300 (7.6)	2.76 (70)	298-9963-ND	50	65.24	SSPM2.5HP-L300	
	120	14.8 (376)	.300 (7.6)	4.0 (102)	298-9964-ND	50	83.26	SSPM4HP-L300	
SUPER-GRIP™ Cable Tie - Nylon - RoHS Compliant									
5	18	4.2 (106)	0.118 (3.0)	1.00 (25)	298-9928-ND	100	15.51	SG100M-C	
	18	4.2 (106)	0.118 (3.0)	1.00 (25)	298-9930-ND	1,000	31.44	SG100M-M	
	40	6.2 (157)	0.168 (4.3)	1.50 (38)	298-9934-ND	1,000	48.08	SG150I-M	
	50	8.3 (211)	0.225 (5.7)	2.00 (51)	298-9936-ND	100	22.67	SG200S-C	
	70	12.4 (315)	0.225 (5.7)	3.20 (81)	298-9940-ND	100	46.25	SG300S-C	
	70	12.4 (315)	0.225 (5.7)	3.20 (81)	298-9942-ND	1,000	172.68	SG300S-M	
	120	15.3 (389)	0.330 (8.4)	4.13 (105)	298-9944-ND	50	39.74	SG350LH-L	
	120	15.3 (389)	0.330 (8.4)	4.13 (105)	298-9946-ND	250	132.18	SG350LH-TL	
	70	15.3 (389)	0.225 (5.7)	4.20 (107)	298-9948-ND	100	52.12	SG370S-C	
	70	15.3 (389)	0.225 (5.7)	4.20 (107)	298-9950-ND	1,000	192.99	SG370S-M	
	SUPER-GRIP Cable Tie - Weather Resistant - Black - RoHS Compliant								
	5	18	4.2 (106)	0.118 (3.0)	1.00 (25)	298-9929-ND	100	20.35	SG100M-C0
18		4.2 (106)	0.118 (3.0)	1.00 (25)	298-9931-ND	1,000	49.23	SG100M-M0	
40		6.2 (157)	0.168 (4.3)	1.50 (38)	298-9933-ND	100	22.05	SG150I-C0	
50		8.3 (211)	0.225 (5.7)	2.00 (51)	298-9937-ND	100	24.22	SG200S-C0	
50		8.3 (211)	0.225 (5.7)	2.00 (51)	298-9939-ND	1,000	72.63	SG200S-M0	
70		12.4 (315)	0.225 (5.7)	3.20 (81)	298-9941-ND	100	49.56	SG300S-C0	
70		12.4 (315)	0.225 (5.7)	3.20 (81)	298-9943-ND	1,000	205.19	SG300S-M0	
120		15.3 (389)	0.330 (8.4)	4.13 (105)	298-9945-ND	50	43.20	SG350LH-L0	

◆ RoHS Compliant

* VELCRO is a registered trademark of the Velcro Companies † See datasheet for additional dimensions (Continued)

More Product Available Online: www.digkey.com



Wire Ties and Accessories (Cont.)

Fig.	Min. Loop Tensile Strength (Lbs)	Length Inch (mm)	Width Inch (mm)	Max. Bundle Diameter Inch (mm)	Digi-Key Part No.	Pkg. Qty.	Price/Pkg.	Panduit Part No.
5	70	15.3 (389)	0.225 (5.7)	4.20 (107)	298-9949-ND	100	55.74	SG370S-CO
	70	15.3 (389)	0.225 (5.7)	4.20 (107)	298-9951-ND	1,000	218.06	SG370S-MO
	175	18.6 (471)	0.380 (9.7)	5.20 (132)	298-9953-ND	100	92.15	SG450H-CO
PAN-TY Push Mount - Nylon - RoHS Compliant								
1	50	7.9 (200.0)	0.180 (4.6)	1.75 (45.0)	298-1358-ND	100	40.81	PLP2S-C
	50	7.9 (200.0)	0.180 (4.6)	1.75 (45.0)	298-1359-ND	1,000	184.58	PLP2S-M
PAN-TY Wing Push Mount - Nylon - RoHS Compliant								
6	18	4.3 (109.0)	0.098 (2.5)	0.87 (22.0)	298-1351-ND	100	33.08	PLWP1M-C
	18	4.3 (109.0)	0.098 (2.5)	0.87 (22.0)	298-1352-ND	500	94.96	PLWP1M-D
	50	5.2 (132.0)	0.190 (4.8)	1.00 (25.0)	298-1353-ND	100	39.65	PLWP1S-C
	40	6.0 (152.0)	0.135 (3.4)	1.25 (32.0)	298-1349-ND	100	37.45	PLWP1.5I-C
	40	6.0 (152.0)	0.135 (3.4)	1.25 (32.0)	298-1350-ND	500	101.90	PLWP1.5I-D
	50	7.8 (198.0)	0.190 (4.8)	1.75 (45.0)	298-1355-ND	100	45.67	PLWP2S-C
50	7.8 (198.0)	0.190 (4.8)	1.75 (45.0)	298-1356-ND	500	110.17	PLWP2S-D	
PAN-TY Wing Push Mount Offset - Nylon - RoHS Compliant								
6	50	6.97 (177)	.190 (4.8)	1.57 (40)	298-9957-ND	50	16.50	PLUP40SE-D
PAN-TY Cable Tie - Weather Resistant - Black - RoHS Compliant								
1	12	2.8 (71.1)	0.070 (1.8)	0.60 (15.2)	298-1037-ND	100	18.79	PLT.6SM-CO
	12	2.8 (71.1)	0.070 (1.8)	0.60 (15.2)	298-1038-ND	1,000	40.50	PLT.6SM-MO
	18	3.1 (78.7)	0.090 (2.3)	0.68 (17.3)	298-1039-ND	1,000	37.33	PLT.7M-MO
	18	3.9 (99.1)	0.098 (2.5)	0.87 (22.1)	298-1040-ND	100	20.13	PLT1M-CO
	18	3.9 (99.1)	0.098 (2.5)	0.87 (22.1)	298-1041-ND	1,000	48.27	PLT1M-MO
	40	5.6 (142.2)	0.142 (3.6)	1.38 (35.1)	298-1042-ND	100	21.86	PLT1.5I-CO
	40	5.6 (142.2)	0.142 (3.6)	1.38 (35.1)	298-1043-ND	1,000	64.31	PLT1.5I-MO
	18	5.6 (142.2)	0.098 (2.5)	1.25 (31.8)	298-1044-ND	100	23.02	PLT1.5M-CO
	18	5.6 (142.2)	0.098 (2.5)	1.25 (31.8)	298-1045-ND	1,000	66.90	PLT1.5M-MO
	50	7.4 (188.0)	0.190 (4.8)	1.88 (47.8)	298-1050-ND	100	24.22	PLT2S-CO
	50	7.4 (188.0)	0.190 (4.8)	1.88 (47.8)	298-1051-ND	1,000	72.63	PLT2S-MO
	40	8.0 (203.2)	0.142 (3.6)	2.00 (50.8)	298-1046-ND	100	32.54	PLT2I-CO
	40	8.0 (203.2)	0.142 (3.6)	2.00 (50.8)	298-1047-ND	1,000	88.07	PLT2I-MO
	18	8.0 (203.2)	0.098 (2.5)	2.00 (50.8)	298-1048-ND	100	28.69	PLT2M-CO
	18	8.0 (203.2)	0.098 (2.5)	2.00 (50.8)	298-1049-ND	1,000	71.70	PLT2M-MO
	40	11.4 (289.6)	0.145 (3.7)	3.00 (76.2)	298-1052-ND	100	44.13	PLT3I-CO
	50	11.5 (292.1)	0.190 (4.8)	3.00 (76.2)	298-1053-ND	100	48.60	PLT3S-CO
	50	11.5 (292.1)	0.190 (4.8)	3.00 (76.2)	298-1054-ND	1,000	201.18	PLT3S-MO
50	14.5 (368.3)	0.190 (4.8)	4.00 (101.6)	298-1055-ND	100	54.11	PLT4S-CO	
50	14.5 (368.3)	0.190 (4.8)	4.00 (101.6)	298-1056-ND	1,000	213.78	PLT4S-MO	
120	17.5 (445.0)	0.190 (4.8)	5.00 (127.0)	298-1362-ND	100	85.78	PLT5S-CO	
120	21.9 (556.0)	0.300 (7.6)	6.00 (152.0)	298-1364-ND	50	65.48	PLT6LH-LO	
120	21.9 (556.0)	0.300 (7.6)	6.00 (152.0)	298-1365-ND	100	84.53	PLT6LH-CO	
120	27.6 (701.0)	0.300 (7.6)	8.00 (203.0)	298-1374-ND	100	130.46	PLT8LH-LO	
120	27.6 (701.0)	0.300 (7.6)	8.00 (203.0)	298-1375-ND	100	99.33	PLT8LH-CO	
BOW-TY® Cable Tie Two Loop - Nylon - RoHS Compliant								
1	50	7.6 (193)	.190 (4.8)	1.8 (45.7)	298-9958-ND	100	53.56	PLB2S-CO
	50	11.8 (300)	.190 (4.8)	3.0 (76.2)	298-9959-ND	100	56.52	PLB3S-CO
	50	14.8 (376)	.190 (4.8)	4.1 (104.1)	298-9960-ND	1,000	285.21	PLB4S-MO
BOW-TY Cable Tie Three Loop - Nylon - RoHS Compliant								
1	125	20.0 (508)	.500 (12.7)	5.0 (127.0)	298-9961-ND	100	294.57	PL3B5EH-CO
BARB-TY® Cable Tie - Nylon Tie With Metal Clip								
1	18	4.0 (101.6)	0.095 (2.4)	0.90 (22.9)	298-1063-ND	100	15.55	BT1M-C
	40	6.1 (154.9)	0.141 (3.6)	1.50 (38.1)	298-1064-ND	100	17.94	BT1.5I-C
	18	6.1 (154.9)	0.095 (2.4)	1.50 (38.1)	298-1071-ND	100	20.81	BT1.5M-C
	18	7.7 (195.6)	0.095 (2.4)	2.00 (50.8)	298-1072-ND	100	21.81	BT2M-C
	40	8.0 (203.2)	0.141 (3.6)	2.00 (50.8)	298-1065-ND	100	27.05	BT2I-C
	50	8.0 (203.2)	0.185 (4.7)	2.00 (50.8)	298-1068-ND	100	22.67	BT2S-C
	18	14.0 (355.6)	0.095 (2.4)	4.00 (101.6)	298-1074-ND	100	31.47	BT4M-C
	120	24.4 (619.8)	0.275 (7.0)	7.00 (177.8)	298-1077-ND	50	65.78	BT7LH-L
	120	27.5 (698.5)	0.275 (7.0)	8.00 (203.2)	298-1078-ND	50	79.66	BT8LH-L
	BARB-TY Cable Tie - Weather Resistant Tie With Metal Clip - Black - RoHS Compliant							
1	18	4.0 (101.6)	0.095 (2.4)	0.90 (22.9)	298-1080-ND	100	20.37	BT1M-CO
	40	6.1 (154.9)	0.141 (3.6)	1.50 (38.1)	298-1081-ND	100	22.05	BT1.5I-CO
	18	7.7 (195.6)	0.095 (2.4)	2.00 (50.8)	298-1089-ND	100	27.46	BT2M-CO
	40	8.0 (203.2)	0.141 (3.6)	2.00 (50.8)	298-1082-ND	100	32.50	BT2I-CO
	50	8.0 (203.2)	0.185 (4.7)	2.00 (50.8)	298-1085-ND	100	24.22	BT2S-CO
	40	11.1 (281.9)	0.141 (3.6)	3.00 (76.2)	298-1083-ND	100	44.52	BT3I-CO
50	11.2 (284.5)	0.185 (4.7)	3.00 (76.2)	298-1086-ND	100	49.56	BT3S-CO	

Fig.	Min. Loop Tensile Strength (Lbs)	Length Inch (mm)	Width Inch (mm)	Max. Bundle Diameter Inch (mm)	Digi-Key Part No.	Pkg. Qty.	Price/Pkg.	Panduit Part No.
1	18	14.0 (355.6)	0.095 (2.4)	4.00 (101.6)	298-1091-ND	100	41.76	BT4M-CO
	40	14.3 (363.2)	0.141 (3.6)	4.00 (101.6)	298-1084-ND	100	58.65	BT4I-CO
	50	14.4 (365.8)	0.185 (4.7)	4.00 (101.6)	298-1087-ND	100	55.74	BT4S-CO
	120	18.1 (459.7)	0.275 (7.0)	5.00 (127.0)	298-1092-ND	50	55.24	BT5LH-LO
	120	24.4 (619.8)	0.275 (7.0)	7.00 (177.8)	298-1094-ND	50	76.88	BT7LH-LO
120	27.5 (698.5)	0.275 (7.0)	8.00 (203.2)	298-1095-ND	50	92.53	BT8LH-LO	
PAN-TY Releasable Tie - Nylon - RoHS Compliant								
1	50	7.4 (188.0)	0.190 (4.8)	1.88 (47.8)	298-1057-ND	100	42.04	PRT2S-C
		11.5 (292.1)		3.00 (76.2)	298-1058-ND	100	71.17	PRT3S-C
		14.5 (368.3)		4.00 (101.6)	298-1059-ND	100	86.61	PRT4S-C
PAN-TY Releasable Tie - Weather Resistant - Black - RoHS Compliant								
1	50	7.4 (188.0)	0.190 (4.8)	1.88 (47.8)	298-1060-ND	100	44.56	PRT2S-CO
		11.5 (292.1)		3.00 (76.2)	298-1061-ND	100	79.59	PRT3S-CO
		14.5 (368.3)		4.00 (101.6)	298-1062-ND	100	95.10	PRT4S-CO
PAN-TY Marker Tie With Write On Area - Nylon - RoHS Compliant								
1	18	3.9 (99.1)	0.098 (2.5)	0.75 (19.1)	298-1011-ND	100	35.43	PLM1M-C
	18	4.3 (109.2)		0.87 (22.1)	298-1010-ND	100	35.15	PLF1M-C
	50	7.4 (188.0)		1.75 (45.0)	298-1012-ND	100	67.01	PLM2S-C
PAN-TY Marker Tie With Write On Area - Weather Resistant - Black - RoHS Compliant								
1	18	3.9 (99.1)	0.098 (2.5)	0.75 (19.1)	298-1014-ND	100	46.12	PLM1M-CO
	50	7.4 (188.0)		1.75 (45.0)	298-1015-ND	100	81.64	PLM2S-CO
	TAK-TY® (VELCRO®) Easy Release And Reuse Brand Cable Tie - Black - RoHS Compliant							
1	50	6.0 (152.4)	0.75 (19.1)	1.50 (38.1)	298-1110-ND	10	11.86	HLS1.5S-XO
	40	8.0 (203.2)	0.50 (12.7)	1.90 (48.3)	298-1113-ND	10	13.68	HLS2I-XO
	40	12.0 (304.8)	0.50 (12.7)	3.20 (81.3)	298-1114-ND	10	17.77	HLS3I-XO
	50	12.0 (304.8)	0.75 (19.1)	3.00 (76.2)	298-1108-ND	10	20.08	HLS3S-XO
	50	12.0 (304.8)	0.75 (19.1)	3.00 (76.2)	298-1111-ND	10	19.79	HLS3S-XO
	50	18.0 (457.2)	0.75 (19.1)	5.00 (127.0)	298-1109-ND	10	24.60	HLS5S-XO
	50	18.0 (457.2)	0.75 (19.1)	5.00 (127.0)	298-1112-ND	10	28.83	HLS5S-XO
	50	15ft. (4.572m)	0.75 (19.1)	Various	298-1115-ND	1 Reel	18.98	HLS-15R0

♦ RoHS Compliant

* VELCRO is a registered trademark of the Velcro Companies † See datasheet for additional dimensions

Fig.	Max. Bundle Diameter Inch (mm)	Length Inch (mm)	Thickness & Width In. (mm)	Min. Loop Tensile Strength Lbs.	Recommend Installation Tools	Digi-Key Part No.	Pkg. Qty.	Price/Pkg.	Panduit Part No.
Metal Locking Tie - Stainless Steel - RoHS Compliant									
1	1.00 (25.4)	5.0 (127.0)	.010 x .18 (25 x 4.4)	100	GS4MT ST2MT or HTMT	298-1100-ND	100	74.51	MLT1S-CP
	2.00 (50.8)	7.9 (200.7)				298-1101-ND	100	72.59	MLT2S-CP
	4.00 (101.6)	14.2 (360.7)				298-1102-ND	100	86.90	MLT4S-CP
WAVE-TY™ Superior Grip Stainless Steel Ties - RoHS Compliant									
7	6.00 (152)	20.5 (521)	.010 x .31 (25 x 7.9)	200	GS4MT ST2MT or HTMT	298-1332-ND	50	96.44	MLT6WH-LP
	8.00 (203)	26.8 (681)				298-1333-ND	50	123.21	MLT8WH-LP
	10.00 (254)	33.0 (838)				298-1334-ND	50	154.01	MLT10WH-LP
Metal Locking Tie - Nylon Coated - RoHS Compliant									
8	2 (51)	7.9 (201)	.010 x .31 (7.9 x .25)	250	GS4MT, HTMT, PPTMT	298-9970-ND	50	158.49	MLT2CH-LP316
	4 (102)	14.3 (362)				298-9971-ND	50	186.00	MLT4CH-LP316
	6 (152)	20.5 (521)				298-9972-ND	50	278.50	MLT6CH-LP316



Fig.	Length Inch (mm)	Width Inch (mm)	Digi-Key Part No.	Pkg. Qty.	Price/Pkg.	Panduit Part No.
Tie Holder With Adhesive - Nylon - RoHS Compliant						
9	0.75 (19.1)	0.75 (19.1)	298-1116-ND	100	85.59	ABMM-A-C
	1.00 (25.4)	1.00 (25.4)	298-1118-ND	100	113.00	ABM100-A-C
	1.12 (28.6)	1.12 (28.6)	298-1268-ND	100	125.69	ABM112-A-C
	1.13 (28.7)	1.13 (28.7)	298-1117-ND	100	130.31	ABMS-A-C
	1.50 (38.1)	1.50 (38.1)	298-1119-ND	50	90.21	ABM3H-A-L

Fig.	Dimensions - Inch (mm)			Pull Apart Force	Digi-Key Part No.	Price Each			Panduit Part No.
	A	B	C			1	50	100	
Swivel Cable Tie Mounts - Weather Resistant Black Nylon									
10	0.87 (22.10)	0.62 (15.75)	0.75 (19.05)	>120 lbs.	298-1308-ND	2.91	—	2.26	TM3-X2-COY
	1.64 (41.66)	0.73 (18.54)	1.23 (31.24)	>250 lbs.	298-1307-ND	3.49	2.71	—	TMEH-X2-LO

♦ RoHS Compliant