

Amphenol® Commercial Products

RJ45 Modular Jacks

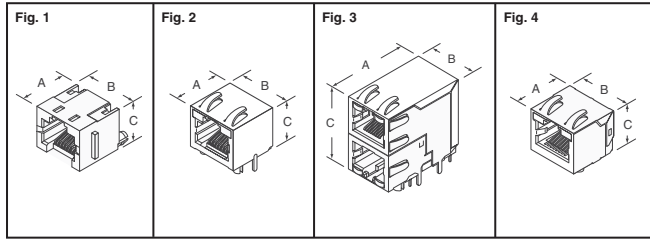

Fig.	Description	Dimensions (mm) A B C	Digi-Key Part No.	Price Each 1 10	Amphenol Part No.
PCB Vertical					
Unshielded					
1	No LED	15.50 15.75 12.83	RJHSE-3080-ND	2.42 1.49	RJHSE-3080
	LED Green-Yellow	15.50 15.75 12.83	RJHSE-3081-ND	2.56 1.64	RJHSE-3081
	LED Green-Green	15.50 15.75 12.83	RJHSE-3085-ND	2.56 1.64	RJHSE-3085
Shielded					
1	No LED	15.88 16.51 13.59	RJHSE-3380-ND	2.73 1.76	RJHSE-3380
	LED Yellow-Green	15.88 16.51 13.59	RJHSE-3381-ND	3.33 2.23	RJHSE-3381
	LED Green-Yellow	15.88 16.51 13.59	RJHSE-3384-ND	3.33 2.23	RJHSE-3384
	LED Green-Green	15.88 16.51 13.59	RJHSE-3385-ND	3.33 2.23	RJHSE-3385
	LED Both Bi-Color	15.88 16.51 13.59	RJHSE-338A-ND	4.97 3.37	RJHSE-338A
PCB Right Angle					
Unshielded					
2	No LED	14.99 15.75 13.21	RJHSE-5080-ND	1.38 .82	RJHSE-5080
	LED Yellow-Green	14.99 15.75 13.21	RJHSE-5081-ND	1.89 1.17	RJHSE-5081
	LED Green-Yellow	14.99 15.75 13.21	RJHSE-5084-ND	1.89 1.17	RJHSE-5084
	LED Green-Green	14.99 15.75 13.21	RJHSE-5085-ND	1.89 1.17	RJHSE-5085
	No LED	18.67 14.60 12.95	FRJAE-408-ND	3.00 1.95	FRJAE-408
Shielded					
2	No LED	15.75 16.51 13.46	RJHSE-5380-ND	2.04 1.33	RJHSE-5380
	LED Yellow-Green	15.75 16.51 13.46	RJHSE-5381-ND	2.55 1.61	RJHSE-5381
	LED Green-Yellow	15.75 16.51 13.46	RJHSE-5384-ND	2.55 1.61	RJHSE-5384
	LED Green-Green	15.75 16.51 13.46	RJHSE-5385-ND	2.55 1.61	RJHSE-5385
	LED Both Bi-Color	15.75 16.51 13.46	RJHSE-538A-ND	3.81 2.52	RJHSE-538A
	With Tabs, No LED	15.75 16.51 13.46	RJHSE-5480-ND	2.04 1.33	RJHSE-5480
	With Tabs, LED Yellow-Green	15.75 16.51 13.46	RJHSE-5481-ND	2.55 1.61	RJHSE-5481
	Filtered, No LED	18.03 13.97 12.70	FRJAE-418-ND	3.56 2.28	FRJAE-418
	Front Tab, No LED	18.03 13.97 12.70	FRJAE-438-ND	3.44 2.24	FRJAE-438

Fig.	Description	Dimensions (mm) A B C	Digi-Key Part No.	Price Each 1 10	Amphenol Part No.
2	Filtered, Rear Tab, No LED	18.03 13.97 12.70	FRJAE-468-ND	3.56 2.28	FRJAE-468
	Rear Tab, No LED	18.03 13.97 12.70	FRJAE-488-ND	3.44 2.24	FRJAE-488
PCB Right Angle — Multi Port					
Unshielded					
2	LED Green-Green, 2 Ports	15.00 31.56 12.70	RJHSE-5085-02-ND	3.67 2.43	RJHSE-5085-02
Shielded					
2	No LED 1x2	15.75 32.26 13.46	RJHSE-5380-02-ND	3.67 2.43	RJHSE-5380-02
	LED Yellow-Green, 2 Ports	15.75 32.26 13.46	RJHSE-5381-02-ND	4.99 3.28	RJHSE-5381-02
	LED Green-Yellow, 2 Ports	15.75 32.26 13.46	RJHSE-5384-02-ND	4.99 3.28	RJHSE-5384-02
	LED Green-Green, 2 Ports	15.75 32.26 13.46	RJHSE-5385-02-ND	4.99 3.28	RJHSE-5385-02
	LED Yellow-Green, 4 Ports	15.76 63.75 13.46	RJHSE-5381-04-ND	6.15 4.10	RJHSE-5381-04
	LED Green-Yellow, 4 Ports	15.76 63.75 13.46	RJHSE-5384-04-ND	6.15 4.10	RJHSE-5384-04
LED Green-Green, 4 Ports	15.76 63.75 13.46	RJHSE-5385-04-ND	6.15 4.10	RJHSE-5385-04	
Shielded - Stacked					
3	LED Yellow-Green, 2 Ports	28.15 16.51 25.40	RJSAE-5381-02-ND	6.92 4.82	RJSAE-5381-02
	LED Green-Green, 2 Ports	28.15 16.51 25.40	RJSAE-5385-02-ND	6.92 4.82	RJSAE-5385-02
	LED Both Bi-Color, 2 Ports	28.15 16.51 25.40	RJSAE-538A-02-ND	8.11 5.76	RJSAE-538A-02
	LED Yellow-Green, 4 Ports	28.15 32.26 25.40	RJSAE-5381-04-ND	11.18 8.27	RJSAE-5381-04
	LED Green-Green, 4 Ports	28.15 32.26 25.40	RJSAE-5385-04-ND	11.18 8.27	RJSAE-5385-04
	LED Both Bi-Color, 4 Ports	28.15 32.26 25.40	RJSAE-538A-04-ND	13.01 9.76	RJSAE-538A-04
	LED Yellow-Green, 8 Ports	28.15 63.75 25.40	RJSAE-5381-08-ND	18.24 13.88	RJSAE-5381-08
	LED Green-Green, 8 Ports	28.15 63.75 25.40	RJSAE-5385-08-ND	18.24 13.88	RJSAE-5385-08
	LED Both Bi-Color, 8 Ports	28.15 63.75 25.40	RJSAE-538A-08-ND	21.69 17.06	RJSAE-538A-08
Surface Mount Right Angle					
Unshielded					
4	Single Port	15.19 16.10 13.08	RJSSE-5080-ND	1.87 1.25	RJSSE-5080
	2 Ports	15.20 31.73 13.27	RJSSE-5080-02-ND	3.13 2.03	RJSSE-5080-02
	4 Ports	15.20 63.30 12.81	RJSSE-5080-04-ND	4.95 3.30	RJSSE-5080-04
Shielded					
4	Single Port	15.75 16.51 13.34	RJSSE-5380-ND	2.33 1.52	RJSSE-5380
	2 Ports	15.75 32.26 13.34	RJSSE-5380-02-ND	4.28 2.90	RJSSE-5380-02
	4 Ports	15.75 63.75 13.34	RJSSE-5380-04-ND	6.82 4.84	RJSSE-5380-04
Surface Mount Right Angle With Light Pipe					
Unshielded					
4	Single Port	15.20 15.98 13.38	RJSSE-5081-ND	2.07 1.28	RJSSE-5081
	2 Ports	15.20 31.73 13.38	RJSSE-5081-02-ND	3.47 2.31	RJSSE-5081-02
	4 Ports	15.20 63.30 13.38	RJSSE-5081-04-ND	5.45 3.76	RJSSE-5081-04
Shielded					
4	Single Port	15.75 16.51 13.34	RJSSE-5381-ND	2.52 1.57	RJSSE-5381
	2 Ports	15.75 32.26 13.34	RJSSE-5381-02-ND	3.47 2.31	RJSSE-5381-02
	4 Ports	15.75 63.75 13.34	RJSSE-5381-04-ND	6.93 4.92	RJSSE-5381-04



I/O INTERCONNECT / Digi-Key®

IDC Modular Cable Assemblies

Style	Positions/ Contacts	Digi-Key* Part No.	Price Each	
			1	100
Straight Cable				
1	4/4	H1443-07-ND	2.51 2.13	1.80 1.54
	8/8	H1883-14-ND	5.58 4.74	4.00 3.42
2	4/4	H244□-14-ND	3.09 2.63	2.22 1.90
	8/8	H288□-14-ND	5.58 4.74	4.00 3.42
3	8/8	H2883-25-ND	7.52 6.39	5.40 4.62
	6/4	H3643-14-ND	2.30 1.96	1.66 1.42
3	8/8	H3881-14-ND	4.03 3.42	2.89 2.47
	8/8	H3882-14-ND	4.03 3.42	2.89 2.47
Coiled Cord				
1	6/6	H1661-05C-ND	5.02 4.27	3.61 3.09
	6/6	H1663-05C-ND	5.02 4.27	3.61 3.09
	8/8	H1883-14C-ND	10.31 8.76	7.39 6.33
2	4/4	H2441-07C-ND	4.39 3.73	3.15 2.69
	4/4	H2442-07C-ND	4.39 3.73	3.15 2.69
	4/4	H2442-10C-ND	5.92 5.03	4.25 3.64
	6/4	H264□-05C-ND	4.60 3.91	3.30 2.82
	8/8	H2881-05C-ND	8.05 6.84	5.78 4.94
	8/8	H2883-07C-ND	7.76 6.60	5.57 4.77
3	6/6	H3662-05C-ND	3.74 3.18	2.69 2.30

* 1 = White, 2 = Black, 3 = Silver Satin.
Note: Custom length also available — minimum order required.

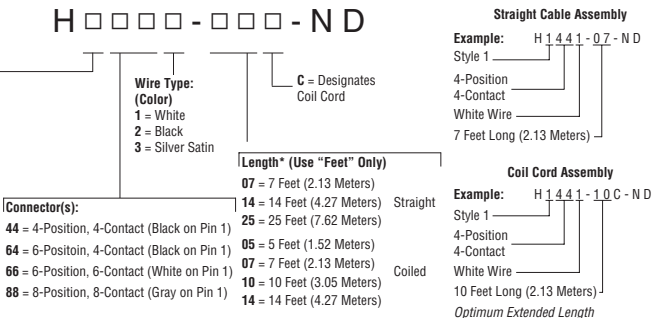
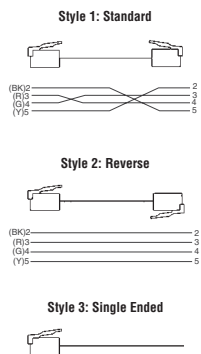
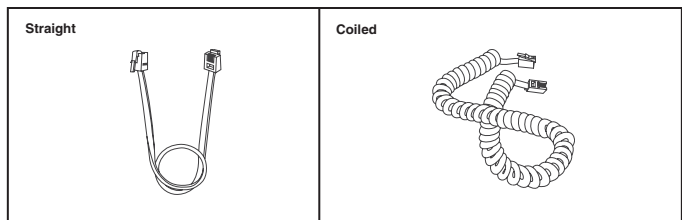

How To Order: 1) You choose your part number simply by substituting the corresponding code to indicate the following: Style, Connector(s), Wire Type, and Length (in feet - not meters).

More Product Available Online: www.digikey.com
Toll-Free: 1-800-344-4539 • Phone 218-681-6674 • Fax: 218-681-3380



IDC Modular Cable Assemblies

A

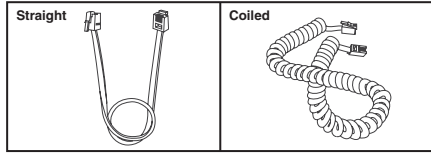
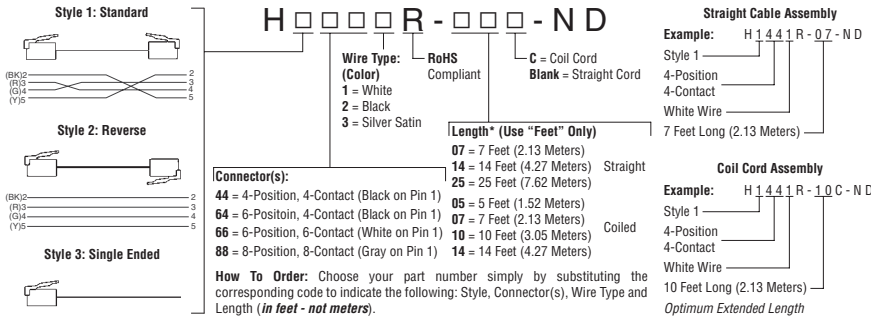

Straight Cable Assemblies

Style	Digi-Key Part No.†	Price Each			
		1	50	100	
4-Position, 4-Contact Assemblies					
1	H1441R-07-ND	2.70	2.29	1.94	1.66
	H1442R-07-ND	2.70	2.29	1.94	1.66
	H1443R-07-ND	1.83	1.56	1.32	1.13
	H1441R-14-ND	2.70	2.30	1.94	1.66
	H1442R-14-ND	3.47	2.95	2.49	2.13
	H1443R-14-ND	3.47	2.95	2.49	2.13
	H1441R-25-ND	4.69	3.98	3.36	2.88
	H1442R-25-ND	4.69	3.98	3.36	2.88
	H1443R-25-ND	4.69	3.98	3.36	2.88
	2	H2441R-07-ND	2.09	1.78	1.51
H2442R-07-ND		2.60	2.21	1.87	1.60
H2443R-07-ND		2.17	1.85	1.56	1.34
H2441R-14-ND		3.47	2.95	2.49	2.13
H2442R-14-ND		3.50	2.97	2.51	2.15
H2443R-14-ND		3.47	2.95	2.49	2.13
H2441R-25-ND		4.69	3.98	3.36	2.88
H2442R-25-ND		3.68	3.13	2.65	2.26
H2443R-25-ND		4.69	3.98	3.36	2.88
3		H3441R-07-ND	2.60	2.21	1.87
	H3442R-07-ND	1.33	1.13	.95	.82
	H3443R-07-ND	2.73	2.32	1.96	1.68
	H3441R-14-ND	2.51	2.13	1.80	1.54
	H3442R-14-ND	2.78	2.37	2.00	1.71
	H3443R-14-ND	2.51	2.13	1.80	1.54
	H3441R-25-ND	3.73	3.17	2.68	2.29
	H3442R-25-ND	3.73	3.17	2.68	2.29
	H3443R-25-ND	3.73	3.17	2.68	2.29
	6-Position, 4-Contact Assemblies				
1	H1641R-07-ND	2.76	2.34	1.98	1.69
	H1642R-07-ND	2.84	2.41	2.04	1.74
	H1643R-07-ND	2.84	2.41	2.04	1.74
	H1641R-14-ND	3.81	3.24	2.74	2.34
	H1642R-14-ND	3.13	2.66	2.25	1.92
	H1643R-14-ND	3.15	2.68	2.27	1.94
	H1641R-25-ND	5.03	4.27	3.61	3.09
	H1642R-25-ND	4.40	3.74	3.16	2.70
	H1643R-25-ND	4.16	3.54	2.99	2.56
	2	H2641R-07-ND	2.52	2.14	1.81
H2642R-07-ND		2.84	2.41	2.04	1.74
H2643R-07-ND		2.84	2.41	2.04	1.74
H2641R-14-ND		3.31	2.82	2.38	2.04
H2642R-14-ND		3.90	3.31	2.80	2.39
H2643R-14-ND		3.13	2.66	2.25	1.92
H2641R-25-ND		4.13	3.51	2.97	2.54
H2642R-25-ND		5.03	4.27	3.61	3.09
H2643R-25-ND		4.74	4.03	3.41	2.91
3		H3641R-07-ND	1.54	1.31	1.11
	H3642R-07-ND	2.81	2.39	2.02	1.73
	H3643R-07-ND	2.81	2.39	2.02	1.73
	H3641R-14-ND	2.68	2.28	1.93	1.65
	H3642R-14-ND	2.25	1.92	1.62	1.39
	H3643R-14-ND	2.25	1.92	1.62	1.39
	H3641R-25-ND	3.90	3.31	2.80	2.39
	H3642R-25-ND	3.90	3.31	2.80	2.39
	H3643R-25-ND	5.14	4.37	3.69	3.16
	6-Position, 6-Contact Assemblies				
1	H1661R-07-ND	3.76	3.20	2.70	2.31
	H1662R-07-ND	3.76	3.20	2.70	2.31
	H1663R-07-ND	3.95	3.36	2.84	2.43
	H1661R-14-ND	4.11	3.49	2.95	2.52
	H1662R-14-ND	4.66	3.96	3.35	2.86
	H1663R-14-ND	4.19	3.56	3.01	2.57
	H1661R-25-ND	5.80	4.93	4.17	3.56
	H1662R-25-ND	5.54	4.71	3.98	3.40
	H1663R-25-ND	7.60	6.46	5.45	4.66
	2	H2661R-07-ND	3.79	3.22	2.72
H2662R-07-ND		3.79	3.22	2.72	2.33
H2663R-07-ND		3.79	3.22	2.72	2.33
H2661R-14-ND		5.38	4.57	3.86	3.30
H2662R-14-ND		4.16	3.54	2.99	2.56

Style	Digi-Key Part No.†	Price Each				
		1	50	100		
2	H2663R-14-ND	3.52	3.00	2.53	2.17	
	H2661R-25-ND	7.60	6.46	5.45	4.66	
	H2662R-25-ND	6.28	5.34	4.51	3.86	
	H2663R-25-ND	5.59	4.75	4.01	3.43	
	H3661R-07-ND	2.17	1.85	1.56	1.34	
	H3662R-07-ND	2.15	1.83	1.54	1.32	
3	H3663R-07-ND	1.83	1.56	1.32	1.13	
	H3661R-14-ND	4.10	3.49	2.95	2.52	
	H3662R-14-ND	4.10	3.49	2.95	2.52	
	H3663R-14-ND	4.10	3.49	2.95	2.52	
	H3661R-25-ND	6.32	5.37	4.53	3.88	
	H3662R-25-ND	6.32	5.37	4.53	3.88	
H3663R-25-ND	6.32	5.37	4.53	3.88		
8-Position, 8-Contact Assemblies						
1	H1881R-07-ND	4.16	3.54	2.99	2.56	
	H1882R-07-ND	4.69	3.99	3.37	2.88	
	H1883R-07-ND	3.92	3.33	2.82	2.41	
	H1881R-14-ND	7.14	6.06	5.12	4.38	
	H1882R-14-ND	7.14	6.06	5.12	4.38	
	H1883R-14-ND	7.14	6.06	5.12	4.38	
	H1881R-25-ND	10.31	8.76	7.40	6.33	
	H1882R-25-ND	10.31	8.76	7.40	6.33	
	H1883R-25-ND	10.31	8.76	7.40	6.33	
	2	H2881R-07-ND	5.12	4.35	3.67	3.14
H2882R-07-ND		4.66	3.96	3.25	2.86	
H2883R-07-ND		4.66	3.96	3.25	2.86	
H2881R-14-ND		7.14	6.06	5.12	4.38	
H2882R-14-ND		6.04	5.13	4.34	3.71	
H2883R-14-ND		6.04	5.13	4.34	3.71	
H2881R-25-ND		5.43	4.62	3.90	3.34	
H2882R-25-ND		10.31	8.76	7.40	6.33	
3		H3881R-07-ND	3.57	3.03	2.56	2.19
		H3882R-07-ND	3.23	2.75	2.32	1.99
	H3883R-07-ND	3.23	2.75	2.32	1.99	
	H3881R-14-ND	5.59	4.75	4.01	3.43	
	H3882R-14-ND	5.59	4.75	4.01	3.43	
	H3883R-14-ND	5.59	4.75	4.01	3.43	
	H3881R-25-ND	8.76	7.44	6.29	5.38	
	H3882R-25-ND	8.76	7.44	6.29	5.38	
	H3883R-25-ND	8.76	7.44	6.29	5.38	

† 1 = White, 2 = Black, 3 = Silver Satin
 Note: Custom length also available – minimum order required.

Coil Cord Assemblies

Style	Digi-Key Part No.†	Price Each			
		1	50	100	
4-Position, 4-Contact Assemblies					
1	H1441R-05C-ND	6.06	5.15	4.35	3.72
	H1442R-05C-ND	3.82	3.24	2.74	2.34
	H1443R-05C-ND	3.79	3.22	2.72	2.33
	H1441R-07C-ND	6.43	5.46	4.61	3.95
	H1442R-07C-ND	3.95	3.36	2.84	2.43
	H1443R-07C-ND	6.11	5.19	4.39	3.75
	H1441R-10C-ND	8.49	7.22	6.10	5.21
	H1442R-10C-ND	5.86	4.98	4.20	3.60
	H1443R-10C-ND	7.28	6.18	5.22	4.47
	H1441R-14C-ND	9.53	8.09	6.84	5.85
2	H2441R-05C-ND	6.06	5.15	4.35	3.72
	H2442R-05C-ND	3.82	3.24	2.74	2.34
	H2443R-05C-ND	5.42	4.61	3.89	3.33
	H2441R-07C-ND	6.43	5.46	4.61	3.95
	H2442R-07C-ND	6.43	5.46	4.61	3.95
	H2443R-07C-ND	6.11	5.19	4.39	3.75
	H2441R-10C-ND	8.49	7.22	6.10	5.21
	H2442R-10C-ND	8.20	6.97	5.89	5.03
	H2443R-10C-ND	7.28	6.18	5.22	4.47
	H2441R-14C-ND	9.53	8.09	6.84	5.85
3	H3441R-05C-ND	5.10	4.33	3.66	3.13
	H3442R-05C-ND	3.21	2.73	2.30	1.97
	H3443R-05C-ND	4.46	3.79	3.20	2.74
	H3441R-07C-ND	5.47	4.65	3.92	3.36
	H3442R-07C-ND	5.47	4.65	3.92	3.36
	H3443R-07C-ND	5.05	2.59	2.19	1.87
	H3441R-10C-ND	7.53	6.40	5.41	4.62
	H3442R-10C-ND	6.31	5.37	4.53	3.88
	H3441R-14C-ND	8.57	7.28	6.15	5.26
	H3442R-14C-ND	4.37	3.72	3.14	2.69
H3443R-14C-ND	8.17	6.94	5.86	5.01	

Style	Digi-Key Part No.†	Price Each			
		1	50	100	
6-Position, 4-Contact Assemblies					
1	H1641R-05C-ND	6.40	5.44	4.59	3.93
	H1642R-05C-ND	5.84	4.96	4.19	3.59
	H1643R-05C-ND	4.35	3.69	3.12	2.67
	H1641R-07C-ND	6.77	5.75	4.86	4.16
	H1642R-07C-ND	6.77	5.75	4.86	4.16
	H1643R-07C-ND	6.45	5.48	4.63	3.96
	H1641R-10C-ND	6.28	5.34	4.51	3.86
	H1642R-10C-ND	8.55	7.26	6.13	5.24
	H1643R-10C-ND	7.62	6.47	5.47	4.68
	H1641R-14C-ND	8.51	7.23	6.10	5.22
2	H1642R-14C-ND	9.02	7.66	6.47	5.54
	H1643R-14C-ND	9.47	8.05	6.80	5.81
	H2641R-05C-ND	6.40	5.44	4.59	3.93
	H2642R-05C-ND	5.84	4.96	4.19	3.59
	H2643R-05C-ND	5.76	4.90	4.14	3.54
	H2641R-07C-ND	6.77	5.75	4.86	4.16
	H2642R-07C-ND	6.77	5.75	4.86	4.16
	H2643R-07C-ND	6.45	5.48	4.63	3.96
	H2641R-10C-ND	8.84	7.51	6.34	5.42
	H2642R-10C-ND	8.55	7.26	6.13	5.24
3	H2643R-10C-ND	7.62	6.47	5.47	4.68
	H2641R-14C-ND	9.87	8.38	7.08	6.06
	H2642R-14C-ND	9.02	7.66	6.47	5.54
	H2643R-14C-ND	9.47	8.05	6.80	5.81
	H3641R-05C-ND	5.27	4.48	3.78	3.23
	H3642R-05C-ND	4.71	4.00	3.38	2.89
	H3643R-05C-ND	4.63	3.94	3.32	2.84
	H3641R-07C-ND	5.64	4.79	4.05	3.46
	H3642R-07C-ND	5.64	4.79	4.05	3.46
	H3643R-07C-ND	5.32	4.52	3.82	3.27
6-Position, 6-Contact Assemblies					
1	H1661R-05C-ND	5.82	4.94	4.18	3.57
	H1662R-05C-ND	5.54	4.71	3.98	3.40
	H1663R-05C-ND	6.32	5.37	4.54	3.88
	H1661R-07C-ND	5.99	5.09	4.30	3.68
	H1				

I/O INTERCONNECT Modular Cable

Flat modular line cord is available in either straight or coiled.

Straight: H004R is sold in hanks of 100, 500 and 1,000 feet, spools of 2,000 feet; H006R, H008R H010 and H010R are sold in hanks of 100 and 500 feet, spools of 1,000 feet.

Coiled: Hxx4□C, Hxx4□RC, Hxx6□C, Hxx6□RC, Hxx8□C, Hxx8□RC, Hxx10□C and Hxx10□RC are sold in 5, 7, 10 and 14 feet approximate optimum in three colors—white (designated by 1 for □ in part number), black (designated by 2 for □ in part number) and silver satin (designated by 3 for □ in part number).

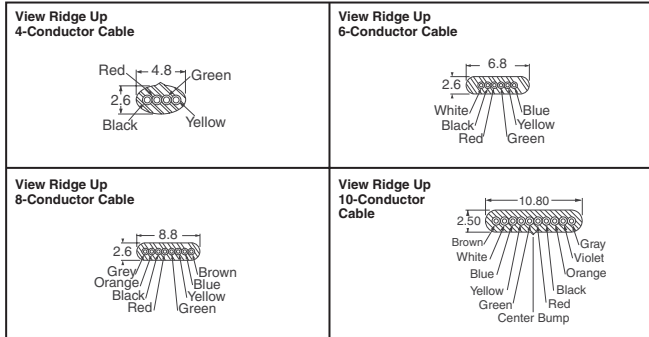

Number of Conductors	Length Feet (Meter)	Digi-Key Part No.†	Price Each
		1	10
Coiled Line Cord - 5 ft. (1.52 meter), 7 ft. (2.13 meter), 10 ft. (3.05 meter) and 14 ft. (4.27 meter) approximate extended lengths - 26 AWG			
4	5 (1.52)	H054□C-ND	2.64
	7 (2.13)	H0741C-ND	2.79
	10 (3.05)	H1042C-ND	4.11
	10 (3.05)	H1043C-ND◆	3.42
6	5 (1.52)	H0563C-ND	2.79
	7 (2.13)	H076□C-ND	2.88
	10 (3.05)	H1061C-ND◆	5.16
	10 (3.05)	H1062C-ND◆	5.16
8	5 (1.52)	H0583C-ND	6.12
	7 (2.13)	H078□C-ND	4.86
	10 (3.05)	H108□C-ND	7.20
	14 (4.27)	H1481C-ND	8.16
10	5 (1.52)	H0510□C-ND◆	5.37
	7 (2.13)	H0710□C-ND◆	5.58
	10 (3.05)	H1010□C-ND◆	7.14
	14 (4.27)	H1410□C-ND◆	7.95

Number of Conductors	Length Feet (Meter)	Digi-Key Part No.†	Price Each
		1	10
Coiled Line Cord - 5 ft. (1.52 meter), 7 ft. (2.13 meter), 10 ft. (3.05 meter) and 14 ft. (4.27 meter) approximate extended lengths - 26 AWG - RoHS Compliant			
4	5 (1.52)	H0541RC-ND	4.68
		H0542RC-ND	4.05
		H0543RC-ND	3.96
	7 (2.13)	H0741RC-ND	5.10
		H0742RC-ND	5.10
		H0743RC-ND	4.74
	10 (3.05)	H1041RC-ND	7.44
		H1042RC-ND	7.11
		H1043RC-ND	6.06
	14 (4.27)	H1441RC-ND	8.61
		H1442RC-ND	7.65
		H1443RC-ND	8.16
6	5 (1.52)	H0561RC-ND	3.69
		H0562RC-ND	3.69
		H0563RC-ND	4.26
	7 (2.13)	H0761RC-ND	5.91
		H0762RC-ND	5.70
		H0763RC-ND	6.12
	10 (3.05)	H1061RC-ND	8.75
		H1062RC-ND	8.75
		H1063RC-ND	5.55
	14 (4.27)	H1461RC-ND	8.75
		H1462RC-ND	9.93
		H1463RC-ND	9.51
8	5 (1.52)	H0581RC-ND	6.75
		H0582RC-ND	6.12
		H0583RC-ND	7.20
	7 (2.13)	H0781RC-ND	6.93
		H0782RC-ND	6.42
		H0783RC-ND	6.55
	10 (3.05)	H1082RC-ND	10.26
		H1083RC-ND	9.76
		H1481RC-ND	11.91
	14 (4.27)	H1482RC-ND	11.55
		H1483RC-ND	10.98

Number of Conductors	Digi-Key Part No.††	Pricing			
		100 ft.	500 ft.	1,000 ft.	2,000 ft.
Straight Line Cord - 26 AWG - RoHS Compliant					
4	H0041R-X-ND	12.52	57.37	104.31	166.90
	H0042R-X-ND	12.52	57.37	104.31	166.90
	H0043R-X-ND	12.52	57.37	104.31	166.90
6	H0061R-X-ND	22.82	104.57	152.10	—
	H0062R-X-ND	22.82	104.57	152.10	—
	H0063R-X-ND	22.82	104.57	152.10	—
8	H0081R-X-ND	32.66	149.67	217.70	—
	H0082R-X-ND	32.66	149.67	217.70	—
	H0083R-X-ND	32.66	149.67	217.70	—
10	H0101R-X-ND	56.70	259.88	378.00	—
	H0102R-X-ND	56.70	259.88	378.00	—
	H0103R-X-ND	56.70	259.88	378.00	—

† 1 = White, 2 = Black, 3 = Silver Satin † "X" in the Digi-Key Part Number represents number of feet.
◆ RoHS Compliant

A

Paladin Tools® Tools



Tester Data/Link ID and Cable-Check™: Tests UTP, STP and flat satin cables with RJ45 terminations. Tests both data and phone connection schemes including patch cords and installed cables to identify: • Good connections • Opens • Shorts • Cross-connections. Identifies data and link transmission speeds with real time detection: 100 MB and 10 MB. Detect PC (NIC) and HUB data transmissions and PC (NIC) and HUB NLP or FLP link pulse.

SureStrip® 4.0: High quality wire stripping and cutting tool for 20-12 AWG (0.5 - 4.0 mm²) • Strips stranded and solid conductors with PVC insulation • Strips multiple conductors and thin, ribbon-cable conductors simultaneously • Built-in wire cutter • Precision self-adjusting blades prevent wire damage • Strips double-insulated cable in two work cycles • User-replaceable stripping blades • Adjustable wire stop to set strip lengths • Value stripper to prepare wire for wire and ferrule termination

Mini-Stripax® Plus: Universal wire stripper and cutter that uses changeable blades to strip PVC and Teflon® insulation. Strips PVC-insulated wire in the range of 28-18 AWG (0.80 - 1.0 mm²) and Teflon-insulated wire in the range of 32-18 AWG (.032 - 1.00 mm²) • Strips flexible and solid conductors with PVC, Teflon, silicone and other special insulations • Strips multiple conductors and thin ribbon-cable conductors simultaneously • Adjustable wire stop and built-in wire cutter • 28-18 AWG (0.80 - 1.00 mm²) PVC blade included

Stripax® Pro 6 Strippers: The new stripax performs powerful stripping of standard and industrial insulations including PVC, THHN, THHW, silicone and polyethylene. Stripping blades are composed of 68 individual spring-compression blades to adjust precisely to the insulation. Not for Teflon or Kapton hard insulations.

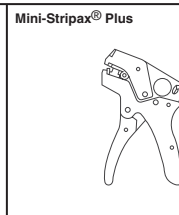
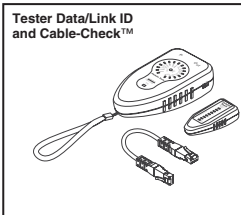

Description	Digi-Key Part No.	Price Each	Paladin Tools Part No.
Tester Data/Link ID and Cable-Check	1576-ND	69.99	1576
Sure Strip 4.0 (AWG 20-12)	PA904893-ND	72.99	904893
Mini-Stripax Plus (AWG 28-18)	PAL1115-ND	96.99	1115P
Replacement Blade for PAL1115-ND	PAL2108-ND	29.99	2108
Stripax Pro 6 (AWG 28-10)	PAL1113.1-ND	85.99	1113.1

Crimp Tools



- Fully ratcheting cycle
- Adjustable crimp tension
- Hardened dies for long life
- Crimp 4, 6, and 8 position
- Cuts and strips cable
- RJ45, RJ11



PAL1530R-ND Modular Crimp Tool..... \$129.99
PAL2530-ND Replacement Blade Set (for 1530R)..... \$9.99

Cable Tester



Features:

- Tests over 20 types of patch cables up to 1,000 feet in length (600 feet for 75Ω coax)
- LAN and telephone • Serial • Coax 50 and 75Ω • USB • VGA • Mini- SB • S-video
- FireWire • PS/2 keyboard • Parallel printer
- 9V battery included

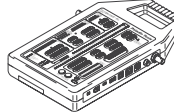

PAL1577-ND Tool PC Cable Tester..... \$189.99

Data and Telephone Tool



Features:

- Crimping cavities for RJ45, RJ11/RJ12 and RJ22 handset modular plugs
- Cuts and strips round UTP/STP phone and data cable along with flat satin phone cable
- 22-28 AWG (.08 - .34mm²) flat or round; solid or stranded telephone and data cables

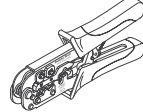

PAL1556-ND All-in-One Data and Telephone Tool..... \$46.99

More Product Available Online: www.digkey.com

Toll-Free: 1-800-344-4539 • Phone 218-681-6674 • Fax: 218-681-3380