

## Round Aluminum Spacers (Non Threaded)

Materials: Brass: Nickel Plate (QQ-N-290)  
Aluminum: Iridite Finish (MIL-C-5541)

Clearance Hole: • .120" for #4 Screw • .140 for #6 Screw • .171 for #8 Screw



Screw (Hole)	Dim. L (Inch)	Brass Spacers Part No.	Pricing		Aluminum Spacers Part No.	Pricing	
			10	100		10	100
#4 (.120)	.125	1909K-ND	3.64	26.05	2036K-ND	2.13	13.20
	.250	1454AK-ND	4.14	29.65	3457K-ND	2.49	13.45
	.375	1454BK-ND	4.87	34.25	3458K-ND	2.96	16.00
	.500	1454CK-ND	5.38	37.55	3459K-ND	3.23	17.75
	.625	1919K-ND	8.24	58.10	2314K-ND	3.57	20.05
	.750	1454DK-ND	7.08	57.20	3460K-ND	4.00	21.60
	.875	1920K-ND	6.53	53.75	3402K-ND	4.49	27.00
	1.000	1454EK-ND	7.73	66.56	3461K-ND	4.28	28.15
	1.500	1924K-ND	16.62	107.80	3462K-ND	11.03	65.45
	2.000	1925K-ND	22.03	142.90	3463K-ND	11.72	76.05
#6 (.140)	.125	1934K-ND	3.64	26.05	3403K-ND	2.13	13.20
	.250	1457AK-ND	4.14	29.65	3464K-ND	2.49	13.45
	.375	1457BK-ND	4.50	31.65	3465K-ND	2.96	16.00
	.500	1457CK-ND	5.28	37.60	3466K-ND	3.23	17.75
	.625	1935K-ND	6.08	42.90	3429K-ND	3.57	20.05
	.750	1457DK-ND	5.38	43.45	3467K-ND	4.00	21.60
	.875	1936K-ND	8.09	66.55	3438K-ND	4.49	27.00
	1.000	1457EK-ND	7.95	68.41	3468K-ND	4.28	28.15
	1.500	1937K-ND	16.62	107.80	3469K-ND	10.37	61.50
	2.000	1938K-ND	21.90	142.70	3470K-ND	11.72	76.05
#8 (.171)	.125	1942K-ND	3.64	26.05	4258K-ND	2.13	13.20
	.250	1480K-ND	4.14	29.65	3471K-ND	2.49	13.45
	.375	1481K-ND	4.41	31.60	3472K-ND	2.96	16.00
	.500	1482K-ND	5.28	37.60	3473K-ND	3.23	17.75
	.625	2032K-ND	5.89	42.35	4259K-ND	3.57	20.05
	.750	1483K-ND	5.23	43.05	3474K-ND	4.00	21.60
	.875	2033K-ND	8.09	66.55	4260K-ND	4.49	27.00
	1.000	1484K-ND	8.33	68.25	3475K-ND	4.28	28.15
	1.500	2034K-ND	16.62	107.80	3476K-ND	10.02	59.45
	2.000	2035K-ND	21.90	142.70	3477K-ND	11.72	76.05

◆ RoHS Compliant

## Nylon Spacers

### Hex Threaded Standoffs

Material: Nylon 6/6 Economical for terminal or printed circuit board supports.

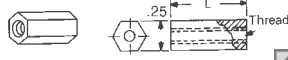

Dim. L (Inch)	4-40 Thread Part No.	6-32 Thread Part No.	8-32 Thread Part No.	Pricing	
				10	100
.250	1902AK-ND	1903AK-ND	1904AK-ND	5.40	32.60
.375	1902BK-ND	1903BK-ND	1904BK-ND	5.53	33.35
.500	1902CK-ND	1903CK-ND	1904CK-ND	5.76	34.90
.625	1902FK-ND	1903FK-ND	1904FK-ND	5.02	41.25
.750	1902DK-ND	1903DK-ND	1904DK-ND	7.40	44.70
.875	1902GK-ND	1903GK-ND	1904GK-ND	5.65	46.55
1.000	1902EK-ND	1903EK-ND	1904EK-ND	8.51	43.61

### Hex Threaded Standoffs - Flame Retardant

Material: Monsanto 340 FR UL 94V-0 rating

Dim. L (Inch)	4-40 Thread Part No.	6-32 Thread Part No.	8-32 Thread Part No.	Pricing	
				10	100
.250	8440AK-ND	8441AK-ND	8442AK-ND	5.98	49.10
.375	8440BK-ND	8441BK-ND	8442BK-ND	6.11	50.25
.500	8440CK-ND	8441CK-ND	8442CK-ND	6.36	52.10
.625	8440DK-ND	8441DK-ND	8442DK-ND	7.57	61.40
.750	8440EK-ND	8441EK-ND	8442EK-ND	21.96	153.48
.875	8440FK-ND	8441FK-ND	8442FK-ND	7.85	64.70
1.000	8440GK-ND	8441GK-ND	8442GK-ND	8.23	67.60

◆ RoHS Compliant

## Round Thru-Hole Spacers

Material: Nylon 6/6



Dim. L (Inch)	#4 Screw .120 Hole Part No.	#6 Screw .140 Hole Part No.	#8 Screw .171 Hole Part No.	Pricing	
				10	100
.125	875K-ND	883K-ND	891K-ND	1.41	10.80
.250	876K-ND	884K-ND	892K-ND	1.54	11.85
.375	877K-ND	885K-ND	893K-ND	1.63	14.70
.500	878K-ND	886K-ND	894K-ND	1.72	16.20
.625	879K-ND	887K-ND	895K-ND	1.86	16.95
.750	880K-ND	888K-ND	896K-ND	1.89	18.20
.875	881K-ND	889K-ND	897K-ND	2.05	20.15
1.000	882K-ND	890K-ND	898K-ND	2.30	21.54

## Rubber Grommets



I.D. A (In.)	For Hole B (Inch)	For Panel C (Inch)	Dim. (Inch)		Digi-Key Part No.	Pricing		
			D	E		10	100	500
.125	.187	.062	.312	.187	730K-ND	1.26	9.20	38.25
.125	.250	.062	.343	.187	733K-ND	1.14	8.25	36.00
.125	.437	.062	.625	.187	734K-ND	10.30	84.75	360.25
.125	.375	.093	.500	.312	735K-ND	4.29	30.80	131.00
.187	.312	.062	.437	.218	736K-ND	1.38	9.85	43.00

I.D. A (In.)	For Hole B (Inch)	For Panel C (Inch)	Dim. (Inch)		Digi-Key Part No.	Pricing		
			D	E		10	100	500
.187	.312	.062	.437	.218	731K-ND	1.38	9.85	43.00
.187	.281	.093	.437	.218	737K-ND	3.30	23.70	100.75
.250	.437	.062	.625	.187	738K-ND	3.42	24.60	105.25
.250	.375	.062	.562	.250	739K-ND	1.74	12.70	53.25
.250	.375	.093	.500	.250	740K-ND	2.96	21.15	90.50
.312	.562	.062	.812	.312	741K-ND	5.38	44.35	187.75
.312	.437	.062	.625	.281	742K-ND	2.40	17.15	73.50
.312	.437	.093	.625	.312	743K-ND	3.67	26.50	112.25
.375	.625	.062	.875	.312	744K-ND	5.79	47.45	202.50
.375	.500	.062	.625	.250	745K-ND	1.88	13.50	57.75
.437	.687	.062	.937	.312	746K-ND	6.39	52.75	223.50
.500	.812	.062	1.062	.312	747K-ND	6.67	53.10	226.25
.500	1.250	.062	1.500	.25	748K-ND	8.13	66.70	283.50
.500	.750	.093	.968	.281	749K-ND	3.46	31.99	135.75
.562	.812	.062	1.062	.312	750K-ND	7.85	64.55	274.25
.625	.875	.062	1.125	.312	752K-ND	4.49	34.20	144.75
.625	1.250	.062	1.500	.250	753K-ND	11.80	97.00	412.00
.750	1.062	.062	1.375	.375	755K-ND	12.03	99.05	420.75
.750	1.437	.062	1.812	.375	756K-ND	24.99	217.50	925.00
.875	1.250	.062	1.625	.437	757K-ND	17.09	151.30	643.75

◆ RoHS Compliant

## Threaded Mounting Brackets

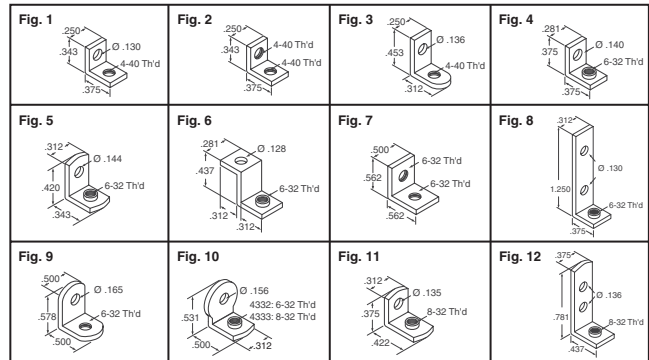
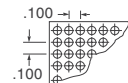

Fig.	Description	Digi-Key Part No.	Pricing	
			10	100
1	.062 Steel, Zinc Plate	612K-ND	2.19	14.80
2	.062 Steel, Zinc Plate	621K-ND	2.82	19.15
3	.047 Brass, Tin Plate	616K-ND	4.35	35.25
4	.032 Brass, Nickel Plate	634K-ND	4.60	29.20
5	.032 Brass, Tin Plate	614K-ND	2.51	19.15
6	.032 Brass, Tin Plate	630K-ND	12.99	103.50
7	.062 Steel, Nickel Plate	4334K-ND	6.03	36.45
8	.062 Steel, Nickel Plate	708K-ND	7.55	62.40
9	.062 Steel, Tin Plate	617K-ND	4.29	34.90
10	.062 Brass, Nickel Plate	4332K-ND	7.04	64.80
10	.062 Brass, Nickel Plate	4333K-ND	7.04	64.80
11	.037 Brass, Tin Plate	611K-ND	4.79	38.95
12	.037 Steel, Tin Plate	631K-ND	4.20	34.05

## Prepunched Insulating Boards



Dimension - Inch Width	Inch Length	Digi-Key Part No.	Pricing		Keystone Part No.
			1	10	
<b>Perfboard - Holes .042" (1.07mm) Dia., Glass Epoxy</b>					
2.00	4.50	3405K-ND	5.22	48.72	3405
2.00	6.00	3406K-ND	6.81	63.56	3406
2.75	17.00	3407K-ND	20.40	190.40	3407
3.00	4.50	3408K-ND	7.11	66.36	3408
4.50	6.00	3409K-ND	9.96	92.96	3409
4.50	6.50	3410K-ND	11.52	107.52	3410
4.50	8.50	3411K-ND	12.24	114.24	3411
4.50	17.00	3412K-ND	27.99	261.24	3412
6.00	17.00	3413K-ND	37.68	351.68	3413

## Miscellaneous Hardware



Description	Digi-Key Part No.	Pricing		Keystone Part No.
		1	10	
<b>LED Spacer Mounts</b>				
Universal Tri-Lead T-1 & T-1 3/4, 0.120"L	8900K-ND	.16	1.53	8900
Universal Tri-Lead T-1 & T-1 3/4, 0.440"L	8918K-ND	.19	1.83	8918
Self-Aligning Bi-Lead T-1, 0.140"L	7352K-ND	.16	1.53	7352
Self-Aligning Bi-Lead T-1 3/4, 0.250"L	8318K-ND	.17	1.59	8318
Self-Aligning Bi-Lead T-1 3/4, 0.340"L	8323K-ND	.18	1.65	8323
<b>Spacers</b>				
Aluminum Economy, #6 screw, 0.625"L	410K-ND	.13	1.27	410
Round, Swage Clear, #6 screw, 0.109"L	5064-2K-ND	.63	5.55	5064-2
<b>Threaded Standoff</b>				
Force-Fit, 4-40 Thread, 0.065"L	4861K-ND	.70	6.16	4861
Phenolic, 6-32 Thread, 0.750"L	386K-ND	.85	7.43	386
Round Swage, 2-56 Thread, 0.125"L	1589-2K-ND	.60	4.73	1589-2
Hex Swage, 6-32 Thread, 0.375"L	1622-2K-ND	.57	5.90	1622-2
PCI Computer Bracket	9203K-ND	2.15	19.80	9203K

More Product Available Online: [www.digikey.com](http://www.digikey.com)

Toll-Free: 1-800-344-4539 • Phone 218-681-6674 • Fax: 218-681-3380

(T083) 2227

**Threaded Standoffs**

- Brass: ASTM-B16
- Plating: Zinc (ASTM B633)
- Aluminum: QQ-A-225/3, Alloy 2011-T3
- Plating: Clear Iridite (Mil-C-5541)

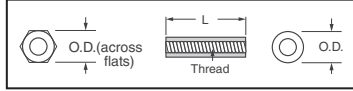

Note: Spacers over 1.000 long are tapped .375 deep each end.

Thread	O.D.	"L" Length (Inch)	Hex Thread Part No.	Pricing		Round Thread Part No.	Pricing	
				10	100		10	100
<b>Aluminum</b>								
2-56	.156	.187	1797AK-ND	5.55	45.60	1801AK-ND	5.22	42.90
		.250	1797BK-ND	5.96	48.90	1801BK-ND	5.16	42.60
		.312	1797CK-ND	6.20	51.00	1801CK-ND	5.58	46.10
		.375	1797DK-ND	6.39	52.55	1801DK-ND	6.45	53.10
4-40	.187	.250	1891K-ND	3.36	20.45	2025K-ND	3.33	20.05
		.375	1892K-ND	3.95	23.80	2026K-ND	3.85	23.60
		.500	1893K-ND	4.35	27.80	2027K-ND	4.24	25.70
		.625	1894K-ND	4.47	30.25	2028K-ND	4.39	28.15
		.750	1895K-ND	4.96	33.95	2029K-ND	4.89	32.60
		.875	1896K-ND	5.45	37.55	2030K-ND	5.35	35.15
1.000	1897K-ND	5.98	49.10	2031K-ND	5.98	49.10		
4-40	.250	.250	2201K-ND	3.25	20.15	3478K-ND	2.95	17.30
		.375	2202K-ND	3.64	22.15	3479K-ND	3.26	20.15
		.500	2203K-ND	4.03	24.50	3480K-ND	3.67	21.70
		.625	1808K-ND	4.34	26.90	1839K-ND	3.98	31.90
		.750	2204K-ND	4.29	29.25	3481K-ND	4.47	26.90
		.875	1809K-ND	4.89	40.50	1846K-ND	4.82	39.60
		1.000	2205K-ND	5.45	45.05	3482K-ND	5.32	43.85
		1.500	2206K-ND	9.29	76.25	3483K-ND	8.99	73.85
		2.000	2207K-ND	10.72	88.30	3484K-ND	10.41	85.50
		6-32	.250	.250	2208K-ND	3.25	20.15	3485K-ND
.375	2209K-ND			3.64	22.15	3486K-ND	3.26	20.15
.500	2210K-ND			4.03	24.50	3487K-ND	3.67	21.70
.625	1813K-ND			4.59	27.40	1847K-ND	4.36	31.40
.750	2211K-ND			4.29	29.25	3488K-ND	4.47	26.90
.875	1816K-ND			4.57	31.00	1848K-ND	4.30	29.40
1.000	2212K-ND			5.45	45.05	3489K-ND	5.32	43.85
1.250	1818K-ND			8.23	67.60	1853K-ND	8.06	66.35
1.500	2213K-ND			9.29	76.25	3490K-ND	8.99	73.85
1.750	1819K-ND			9.70	79.80	1855K-ND	9.54	78.50
2.000	2214K-ND			10.72	88.30	3491K-ND	10.41	85.50
2.250	1820K-ND			11.90	97.80	1856K-ND	11.58	95.20
2.500	1825K-ND			12.08	107.10	1857K-ND	11.79	104.50
8-32	.250			.250	2215K-ND	3.25	20.15	3492K-ND
		.375	2216K-ND	3.64	22.15	3493K-ND	3.26	20.15
		.500	2217K-ND	4.03	24.50	3494K-ND	3.67	21.70
		.625	1827K-ND	4.44	31.90	1858K-ND	3.98	24.75
		.750	2218K-ND	4.19	34.30	3495K-ND	4.47	26.90
		.875	1828K-ND	5.21	42.75	1859K-ND	4.33	29.05
		1.000	2219K-ND	5.45	45.05	3496K-ND	5.32	43.85
		1.500	2220K-ND	9.29	76.25	3497K-ND	10.44	84.25
2.000	2221K-ND	10.72	88.30	3498K-ND	10.41	85.50		
8-32	.375	.375	1926AK-ND	4.80	39.60	2315AK-ND	7.10	61.90
		.500	1926BK-ND	5.03	41.20	2315BK-ND	7.97	65.50
		.625	1926CK-ND	6.58	54.00	2315CK-ND	8.59	70.60
		.750	1926DK-ND	7.64	62.75	2315DK-ND	9.21	75.70
		1.000	1926EK-ND	8.61	74.01	2315EK-ND	10.20	87.99
<b>Brass</b>								
2-56	.156	.187	1798AK-ND	6.76	55.65	1802AK-ND	6.39	52.70
		.250	1798BK-ND	8.07	66.35	1802BK-ND	6.87	56.45
		.312	1798CK-ND	9.71	79.85	1802CK-ND	7.12	58.65
		.375	1798DK-ND	10.45	86.10	1802DK-ND	7.12	58.65
4-40	.187	.250	1450K-ND	4.67	26.90	1547K-ND	4.69	24.80
		.375	1803K-ND	5.47	30.85	1864K-ND	5.40	37.40
		.500	1656K-ND	5.61	36.45	1657K-ND	5.55	35.80
		.625	1804K-ND	6.82	49.15	1865K-ND	6.80	42.15
		.750	1656AK-ND	7.71	46.60	1657AK-ND	7.51	45.40
		.875	1805K-ND	9.46	60.30	1866K-ND	9.44	58.20
1.000	1656BK-ND	9.94	60.30	1657BK-ND	9.86	57.80		
4-40	.250	.250	1450AK-ND	4.36	24.95	1547AK-ND	5.02	36.05
		.375	1450BK-ND	5.46	28.85	1547BK-ND	5.88	42.15
		.500	1450CK-ND	5.52	36.25	1547CK-ND	6.27	51.45
		.625	1829K-ND	7.46	49.00	1867K-ND	7.08	58.20
		.750	1450DK-ND	8.53	57.25	1547DK-ND	7.93	65.30
		.875	1830K-ND	9.08	59.50	1876K-ND	8.94	73.50
		1.000	1450EK-ND	9.61	63.29	1547EK-ND	4.11	24.80
		1.500	1831K-ND	16.88	149.60	1877K-ND	16.49	143.30
		2.000	1832K-ND	17.30	153.40	1878K-ND	19.98	173.70
		6-32	.250	.250	1451AK-ND	4.36	24.95	1548AK-ND
.375	1451BK-ND			5.46	28.85	1548BK-ND	4.76	26.90
.500	1451CK-ND			5.52	36.25	1548CK-ND	5.55	34.85
.625	1451DK-ND			7.46	49.00	1548DK-ND	6.07	46.60
.750	1451EK-ND			7.32	55.60	1548EK-ND	6.60	54.32
.875	1833K-ND			9.08	59.50	1879K-ND	8.51	58.05
1.000	1635K-ND			9.61	57.80	1548FK-ND	8.84	56.90
1.250	1636K-ND			12.51	102.85	1881K-ND	12.27	101.05
1.500	1637K-ND			14.46	118.80	1882K-ND	16.38	145.05
1.750	1638K-ND			17.10	151.45	1883K-ND	16.59	146.95
2.000	1639K-ND	17.30	153.40	1884K-ND	16.74	148.30		

Thread	O.D.	"L" Length (Inch)	Hex Thread Part No.	Pricing		Round Thread Part No.	Pricing	
				10	100		10	100
6-32	.250	2.250	1642K-ND	17.66	156.40	1885K-ND	17.17	151.90
		2.500	1643K-ND	18.17	160.75	1886K-ND	17.66	156.40
8-32	.250	.250	1474AK-ND	4.36	27.80	1692AK-ND	5.26	43.20
		.375	1474BK-ND	5.46	28.85	1692BK-ND	5.51	45.40
		.500	1474CK-ND	5.52	36.25	1692CK-ND	7.02	57.75
		.625	1834K-ND	7.46	49.00	1877K-ND	8.03	65.85
		.750	1474DK-ND	8.53	57.25	1692DK-ND	9.51	78.15
		.875	1836K-ND	9.77	62.90	1888K-ND	9.10	75.05
		1.000	1474EK-ND	8.23	56.24	1692EK-ND	8.40	78.36
		1.500	1837K-ND	16.88	149.60	1889K-ND	16.38	145.05
		2.000	1838K-ND	17.30	153.40	1899K-ND	17.60	156.05
		8-32	.375	.375	1452AK-ND	9.84	79.35	1549AK-ND
.500	1452BK-ND			9.85	80.90	1549BK-ND	11.14	91.65
.625	1452CK-ND			14.62	117.95	1549CK-ND	14.23	115.00
.750	1452DK-ND			13.84	111.65	1549DK-ND	15.60	125.95
1.000	1452EK-ND			16.45	141.44	1549EK-ND	16.97	158.25

◆ RoHS Compliant

1/4" Hex Threaded Standoff Kit

Aluminum - Assortment of 1500 pieces in 1/4", 3/8", 1/2", 3/4" and 1" lengths with thread sizes of 4-40, 6-32 and 8-32. 100 pieces of each size complete with cabinet.

STH-22KIT-ND (RoHS Compliant) ..... \$738.15

**Male/Female .250" Hex Threaded Standoffs**

- Brass: ASTM-B16
- Plating: Nickel (QQ-N-290)

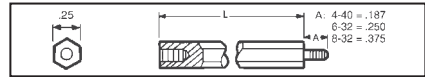

- Aluminum: QQ-Q-225/3
- Plating: Clear Iridite (Mil-C-5541)

Length (Inch)	4-40 Thread Part No.	Pricing		6-32 Thread Part No.	Pricing		8-32 Thread Part No.	Pricing	
		10	100		10	100		10	100
<b>Aluminum</b>									
.250	8714K-ND*	3.77	26.80	8717K-ND*	4.18	29.80	—	—	—
.375	8400K-ND†	4.28	30.35	8413K-ND†	4.43	31.55	8426K-ND†	5.13	41.60
.500	8401K-ND	5.22	42.40	8414K-ND	4.49	31.80	8427K-ND	5.22	42.40
.625	8402K-ND	5.62	45.45	8415K-ND	4.96	40.10	8428K-ND	5.62	45.45
.750	8403K-ND	5.71	46.35	8416K-ND	5.00	40.60	8429K-ND	5.98	48.55
.875	8404K-ND	6.20	50.35	8417K-ND	5.44	44.15	8430K-ND	6.64	53.90
1.000	8405K-ND	6.56	53.20	8418K-ND	5.71	46.35	8431K-ND	7.05	57.15
1.125	8406K-ND	8.03	65.00	8419K-ND	5.89	47.75	8432K-ND	9.45	77.85
1.250	8407K-ND	8.12	65.90	8420K-ND	6.29	51.00	8433K-ND	9.79	80.50
1.375	8408K-ND	9.51	78.25	8421K-ND	7.14	57.90	8434K-ND	10.57	86.95
1.500	8409K-ND	9.73	79.95	8422K-ND	8.16	66.35	8435K-ND	10.68	87.90
1.625	8410K-ND	10.01	82.40	8423K-ND	8.29	67.20	8436K-ND	10.79	88.60
1.750	8411K-ND	10.24	84.15	8424K-ND	8.69	70.60	8437K-ND	10.90	89.85
2.000	8412K-ND	10.57	86.95	8425K-ND	8.87	72.15	8438K-ND	11.02	90.65
<b>Brass</b>									
.250	8713K-ND*	5.43	38.55	8716K-ND*	5.30	37.60	—	—	—
.375	7200K-ND†	5.25	42.50	7210K-ND†	5.41	44.00	7220K-ND†	6.29	50.90
.500	1944K-ND	6.85	55.60	1952K-ND	5.91	47.95	1957K-ND	6.36	51.45
.625	1945K-ND	6.96	56.30	1953K-ND	7.51	60.80	1958K-ND	8.84	71.65
.750	1946K-ND	8.28	67.20	1954K-ND	7.89	64.10	1959K-ND	9.28	75.50
.875	7201K-ND	8.39	68.10	7211K-ND	9.06	73.50	7221K-ND	10.16	82.40
1.000	1947K-ND	9.28	75.50	1644K-ND	9.33				

**Metric Hex Threaded Standoffs**

- **Brass:** ASTM-B16  
**Plating:** Nickel (QQ-N-290)
- **Aluminum:** ASTM B211  
**Plating:** Clear Iridite (Mil-C-5541)
- **Nylon:** 6/6, UL Rated 94V-2

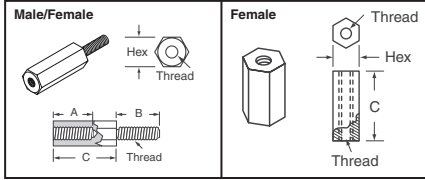

Dimensions – mm			Digi-Key Part No.	Pricing	
A	B	C		10	100
<b>5mm Hex (M3 Thread)</b>					
<b>Brass - Male/Female</b>					
8.0	8.0	10.0	24313K-ND	7.98	65.55
		12.0	24314K-ND	8.19	67.20
		15.0	24315K-ND	8.54	70.20
		18.0	24316K-ND	9.22	76.05
		20.0	24317K-ND	9.49	78.15
		25.0	24318K-ND	10.46	86.10
<b>Brass - Female</b>					
—	—	5.0	24390K-ND	5.24	43.20
		6.0	24391K-ND	4.17	36.05
		8.0	24392K-ND	5.44	47.75
		10.0	24393K-ND	5.02	41.25
		12.0	24394K-ND	4.81	43.20
		15.0	24395K-ND	6.91	56.70
		18.0	24396K-ND	5.52	48.75
		20.0	24397K-ND	8.14	66.85
		25.0	24398K-ND	8.93	73.50
<b>Aluminum - Male/Female</b>					
8.0	8.0	10.0	24337K-ND	3.26	28.90
		12.0	24338K-ND	4.54	40.40
		15.0	24339K-ND	4.89	43.30
		18.0	24340K-ND	4.97	44.10
		20.0	24341K-ND	5.40	47.95
		25.0	24342K-ND	5.71	50.65
<b>Aluminum - Female</b>					
—	—	5.0	24430K-ND	2.52	19.50
		6.0	24431K-ND	2.48	19.15
		8.0	24432K-ND	2.76	21.10
		10.0	24433K-ND	2.77	21.05
		12.0	24434K-ND	3.07	23.35
		15.0	24435K-ND	3.31	25.60
		18.0	24436K-ND	3.74	27.85
		20.0	24437K-ND	4.26	38.55
		25.0	24438K-ND	4.75	42.90
<b>Nylon - Male/Female</b>					
8.0	8.0	10.0	25501K-ND	3.42	30.80
		12.0	25502K-ND	3.56	31.90
		15.0	25503K-ND	3.63	32.55
		18.0	25504K-ND	3.70	33.20
		20.0	25505K-ND	3.76	33.85
		25.0	25506K-ND	3.83	34.50
<b>Nylon - Female</b>					
—	—	6.0	25508K-ND	4.70	31.05
		8.0	25509K-ND	5.00	33.00
		10.0	25510K-ND	4.81	31.80
		12.0	25511K-ND	5.01	33.20
		15.0	25512K-ND	4.37	39.30
		18.0	25513K-ND	6.44	42.60
		20.0	25514K-ND	4.92	44.35
				25.0	25515K-ND
<b>6mm Hex (M4 Thread)</b>					
<b>Brass - Male/Female</b>					
11.0	10.0	10.0	24325K-ND‡	4.43	39.15
		12.0	24326K-ND†	4.47	39.60
		15.0	24327K-ND	6.21	55.15
		18.0	24328K-ND	6.52	58.05
		20.0	24329K-ND	7.15	63.40
		25.0	24330K-ND	7.50	66.55
<b>Brass - Female</b>					
—	—	5.0	24410K-ND	2.73	21.75
		6.0	24411K-ND	2.68	21.40
		8.0	24412K-ND	3.13	22.90
		10.0	24413K-ND	3.36	22.20
		12.0	24414K-ND	3.88	27.85
		15.0	24415K-ND	6.00	44.00
		18.0	24416K-ND	6.38	45.80
		20.0	24417K-ND	6.00	44.00
		25.0	24418K-ND	6.76	44.45
<b>Aluminum - Male/Female</b>					
11.0	10.0	10.0	24349K-ND‡	4.47	39.60
		12.0	24350K-ND†	4.54	40.40
		15.0	24351K-ND	4.89	43.30
		18.0	24352K-ND	5.20	46.20
		20.0	24353K-ND	5.79	51.30
		25.0	24354K-ND	6.13	54.45
<b>Aluminum - Female</b>					
—	—	5.0	24450K-ND	2.52	19.50
		6.0	24451K-ND	2.48	19.15
		8.0	24452K-ND	2.76	21.10
		10.0	24453K-ND	2.77	21.05
		12.0	24454K-ND	3.07	23.35
		15.0	24455K-ND	3.39	30.40
		18.0	24456K-ND	3.65	32.65
		20.0	24457K-ND	4.53	40.70
		25.0	24458K-ND	4.75	42.90
<b>Nylon - Male/Female</b>					
9.5	9.5	10.0	25521K-ND	3.42	30.80
		12.0	25522K-ND	3.56	31.90

Dimensions – mm			Digi-Key Part No.	Pricing	
A	B	C		10	100
9.5	9.5	15.0	25523K-ND	3.63	32.55
		18.0	25524K-ND	3.70	33.20
		20.0	25525K-ND	3.76	33.85
		25.0	25526K-ND	3.83	34.50
<b>Nylon - Female</b>					
—	—	6.0	25528K-ND	4.70	31.05
		8.0	25529K-ND	5.00	33.00
		10.0	25530K-ND	4.81	31.80
		12.0	25531K-ND	5.01	33.20
		15.0	25532K-ND	4.37	39.30
		18.0	25533K-ND	6.44	42.60
		20.0	25534K-ND	4.92	44.35
		25.0	25535K-ND	6.48	42.70

‡ Internal Thread: 6.0mm deep † Internal Thread: 8.0mm deep  
Note: Female Standoffs longer than 19mm are tapped from both ends

**Metric Screws**

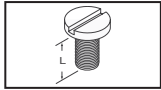

- **Steel:** Zinc Plated
- **Nylon:** 6/6, UL Rated 94V-2

Thread Size	Length – mm L	Digi-Key Part No.	Pricing	
			10	100
<b>Steel</b>				
M3	6	29311K-ND	2.45	22.70
	12	29314K-ND	2.54	23.50
	16	29316K-ND	2.80	25.85
	25	29318K-ND	2.89	26.75
M4	6	29321K-ND	2.63	24.35
	12	29324K-ND	2.74	25.35
	16	29326K-ND	3.21	29.70
	25	29328K-ND	3.58	33.15
<b>Nylon</b>				
M3	6	29341K-ND	1.24	11.85
	12	29344K-ND	1.28	12.20
	16	29346K-ND	1.29	12.25
	25	29348K-ND	1.31	12.45
M4	6	29351K-ND	1.36	12.95
	12	29354K-ND	1.38	13.20
	16	29356K-ND	1.39	13.25
	25	29358K-ND	1.40	13.40

**Hinged Standoffs**

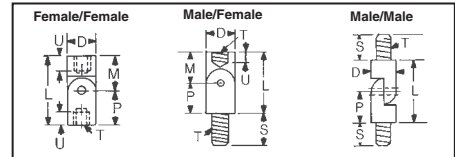

Thread T	Dia. – Inch D	Dimensions – Inch				Digi-Key Part No.	Pricing		
		L	S	U	M		P	10	100
<b>Female/Female-Hinge</b>									
4-40	.187	.750	—	.172	.375	.375	351K-ND	15.08	87.70
4-40	.187	1.000	—	.250	.375	.625	352K-ND	16.08	93.60
6-32	.250	.750	—	.172	.375	.375	353K-ND	21.51	124.85
6-32	.250	1.000	—	.250	.375	.625	354K-ND	21.97	127.80
8-32	.250	.750	—	.172	.375	.375	355K-ND	19.44	113.30
8-32	.250	1.000	—	.250	.375	.625	356K-ND	20.45	119.05
<b>Male/Female-Hinge</b>									
4-40	.187	.625	.250	.172	.375	.250	333K-ND	17.68	102.85
4-40	.187	.875	.250	.250	.625	.250	334K-ND	18.67	108.45
6-32	.250	.625	.312	.172	.375	.250	335K-ND	21.27	123.75
6-32	.250	.875	.312	.250	.625	.250	336K-ND	21.73	126.50
<b>Male/Male-Hinge</b>									
4-40	.187	.500	.250	—	—	.250	357K-ND	20.28	118.15
6-32	.250	.500	.312	—	—	.250	358K-ND	21.04	122.35
8-32	.250	.500	.312	—	—	.250	359K-ND	23.62	137.25

**Ceramic Standoffs**

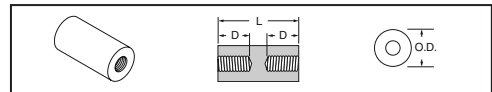

Thread Size	Diameter (Inch) O.D.	Length (Inch) L	Depth (Inch) D (2)	Digi-Key Part No.	Pricing	
					10	100
6-32	.250	.250	thru	7710K-ND◆	27.33	192.70
	.250	.500	.156	7711K-ND◆	31.08	215.30
	.375	.375	.156	7712K-ND	23.54	164.70
	.375	.500	.187	7713K-ND◆	26.64	187.05
	.500	.500	.140	7714K-ND	28.88	204.00
	.500	.750	.250	7715K-ND◆	30.33	215.30
	.500	1.000	.375	7716K-ND◆	32.52	226.60
	.500	1.500	.562	7717K-ND	38.43	272.05
	.500	2.500	.500	7718K-ND◆	46.24	339.30
	1/4-20	.750	2.500	.750	7719K-ND◆	64.44
.750		4.000	.750	7720K-ND	77.83	583.94

◆ RoHS Compliant

More Product Available Online: [www.digkey.com](http://www.digkey.com)

Toll-Free: 1-800-344-4539 • Phone 218-681-6674 • Fax: 218-681-3380