

Series P2N – Panasonic Series #EVM-2NSX80BXX

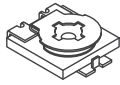

Features: 2mm open frame type for reflow soldering; Resistance Range: 200-1.0MΩ; Tolerance: ±25%; Taper: B; Power Rating: .15W; Adjustment Angle: 260 ±20; Rotation Torque: 0.5-10 mN; Operating Temperature: -40°C - 100°C; Temperature Coefficient: ±250 ppm/C (-40°C - 100°C); Rotation Life: 10; Soldering Heat: 240°C 5s

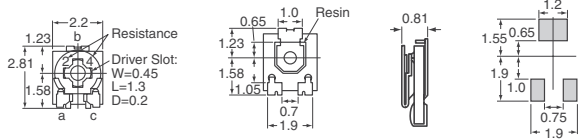

Series P2W – Panasonic Series #EVM-2WSX80BXX

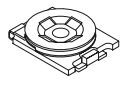

Features: • 2mm open frame type for reflow soldering; Resistance Range: 200-1.0MΩ; Tolerance: ±25%; Taper: Linear; Power Rating: .15W; Adjustment Angle: 260 ±20; Rotation Torque: 10-150 gF; Operating Temperature: -20°C - 85°C; Temperature Coefficient: ±250 ppm/C (-20°C - 85°C); Rotation Life: 20; Soldering Heat: 240°C 5s

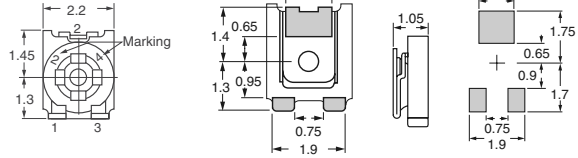

Series P2X – Panasonic Series #EVM-2XSX50BXX

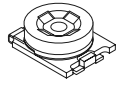

Features: • 2mm open frame type for reflow soldering; Resistance Range: 200-1.0MΩ; Tolerance: ±25%; Taper: Linear; Power Rating: .15W; Adjustment Angle: 260 ±20; Rotation Torque: 10-150 gF; Operating Temperature: -20°C - 85°C; Temperature Coefficient: ±250 ppm/C (-20°C - 85°C); Rotation Life: 20; Soldering Heat: 240°C 5s

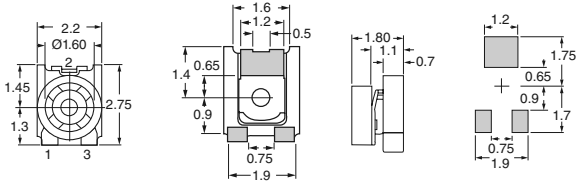

Series P3R – Panasonic Series #EVM-3RSX50BXX

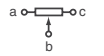

Features: • 3mm open frame type for reflow soldering; Resistance Range: 500-1MΩ; Tolerance: ±25%; Taper: B; Power Rating: .15W; Adjustment Angle: 260 ±20; Rotation Torque: 1-20 mN; Operating Temperature: -40°C - 100°C; Temperature Coefficient: ±250 ppm/C (-40°C - 100°C); Rotation Life: 10; Soldering Heat: 240°C 5s

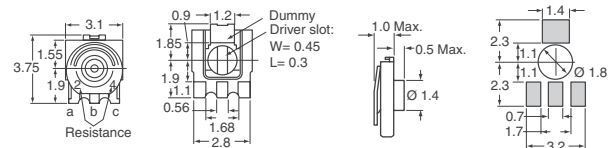

Series P3Y – Panasonic Series #EVM-3YSX50BXX



Features: • 3mm open frame type for reflow soldering; Resistance Range: 100-1.0MΩ; Tolerance: ±25%; Taper: Linear; Power Rating: .15W; Adjustment Angle: 240 ±20; Rotation Torque: 20-200 gF; Operating Temperature: -20°C - 85°C; Temperature Coefficient: ±250 ppm/C (-20°C - 85°C); Rotation Life: 20; Soldering Heat: 240°C 5s

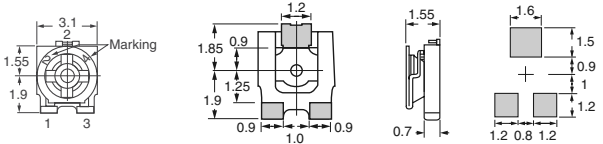

Series P3V – Panasonic Series #EVM-3VSX50BXX

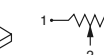

Features: • 3mm open frame type for reflow soldering • Rotation stopper feature; Resistance Range: 500-1MΩ; Tolerance: ±25%; Taper: Linear; Power Rating: .15W; Adjustment Angle: 240 ±20; Rotation Torque: 20-100 gF; Operating Temperature: -20°C - 85°C; Temperature Coefficient: ±250 ppm/C (-20°C - 85°C); Rotation Life: 20; Soldering Heat: 240°C 5s

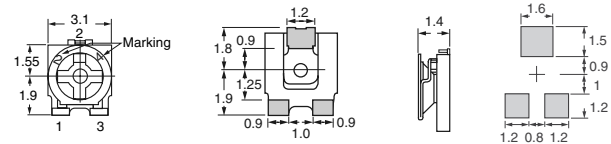

Series P3W – Panasonic Series #EVM-3WSX80BXX



Features: • 3mm open frame type for reflow soldering; Resistance Range: 100-1.0MΩ; Tolerance: ±25%; Taper: Linear; Power Rating: .15W; Adjustment Angle: 240 ±20; Rotation Torque: 20-200 gF; Operating Temperature: -20°C - 85°C; Temperature Coefficient: ±250 ppm/C (-20°C - 85°C); Rotation Life: 20; Soldering Heat: 240°C 5s

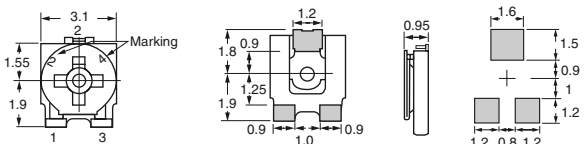

Series P1U – Panasonic Series #EVM-1USX30BXX

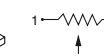
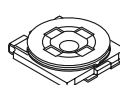

Features: • 4mm open frame type for reflow soldering; Resistance Range: 100-1.0MΩ; Tolerance: ±25%; Taper: Linear; Power Rating: .2W; Adjustment Angle: 260 ±20; Rotation Torque: 20-200 gF; Operating Temperature: -20°C - 100°C; Temperature Coefficient: ±250 ppm/C (25°C - 100°C); Rotation Life: 20; Soldering Heat: 240°C 5s

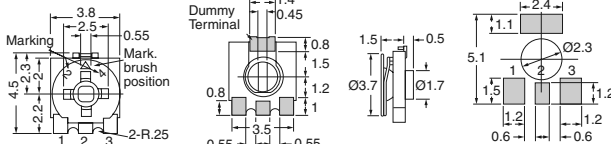

G

Digi-Key Part No.	Cut Tape Pricing	Digi-Key Part No.	Tape & Reel Pricing	Panasonic Part No.
	1 10 100		1,000 2,000 3,000	
P2N□□□CT-ND†	.66 5.48 50.37	P2N□□□TR-ND†	— — 329.00/M	EVM-2NSX80BXX*
P2W□□□CT-ND†	.63 5.25 48.30	P2W□□□TR-ND†	— — 323.00/M	EVM-2WSX80BXX*
P2X□□□CT-ND†	.61 5.05 46.46	P2X□□□TR-ND†	— 311.00/M —	EVM-2XSX50BXX*
P3R□□□CT-ND†	.81 6.76 62.16	P3R□□□TR-ND†	— 405.00/M —	EVM-3RSX50BXX*
P3Y□□□CT-ND†	.42 3.50 32.20	P3Y□□□TR-ND†	— 215.00/M —	EVM-3YSX50BXX*
P3V□□□CT-ND†	.52 4.35 40.02	P3V□□□TR-ND†	— 268.00/M —	EVM-3VSX50BXX*
P3W□□□CT-ND†	.52 4.35 40.02	P3W□□□TR-ND†	— — 268.00/M	EVM-3WSX80BXX*
P1U□□□CT-ND†	.61 5.05 46.46	P1U□□□TR-ND†	311.00 — —	EVM-1USX30BXX*

◆ RoHS Compliant * For assistance with Panasonic Part Number, please call Digi-Key.
† For complete number, substitute corresponding code (from chart) for □□□.

Code Resistance Value For P2N / P2W / P2X Series						
Code (Value)	Code (Value)	Code (Value)	Code (Value)	Code (Value)	Code (Value)	Code (Value)
201 (200)	501 (500)	102 (1.0K)	202 (2.0K)	502 (5.0K)	103 (10K)	203 (20K)
	503 (50K)	104 (100K)	204 (200K)	504 (500K)	105 (1.0M)	
Code Resistance Value For P3Y / P3V / P1U Series						
Code (Value)	Code (Value)	Code (Value)	Code (Value)	Code (Value)	Code (Value)	Code (Value)
101 (100)	201 (200)	501 (500)	102 (1.0K)	202 (2.0K)	502 (5.0K)	103 (10K)
203 (20K)	503 (50K)	104 (100K)	204 (200K)	504 (500K)	105 (1.0M)	
Code Resistance Value For P3R / P3W Series						
Code (Value)	Code (Value)	Code (Value)	Code (Value)	Code (Value)	Code (Value)	Code (Value)
501 (500)	102 (1K)	202 (2K)	502 (5K)	103 (10K)	203 (20K)	503 (50K)
104 (100K)	204 (200K)	504 (500K)	105 (1M)			

More Product Available Online: www.digikey.com

Toll-Free: 1-800-344-4539 • Phone 218-681-6674 • Fax: 218-681-3380

EVM-EAG / EAS / EGG / EGS Series:

Dustproof Type with Knob Protection: Features: • No readjustment needed through knob protected construction • Excellent mounting efficiency due to cubic shape • Automated adjustment available. Face side: Standard cross slot screwdriver suited to automatic adjustment applicable. Back side: Penetrated slot for easy driving. **Applications:** • Audio visual equipment, home appliances.

Specifications: • Rotation Torque: 20 to 300gf • Stopper Strength: 500gf • Rotation Angle: 210° ± 20°. • TCR: ±200ppm (-30°C - 100°C) • Nominal Total Resistance & Tolerance: ±25% • Power Rating & Maximum Operating Voltage: 0.3W, 100V (70°C) • Residual Resistance: 10Ω maximum for R<1kΩ, 1% maximum for 1kΩ<R<100kΩ, 5% maximum for R≥100kΩ • Soldering Heat: 5s maximum 240 to 280°C, 3s maximum 280 to 300°C • Rotation Life: 50 turns

EVM-EYG and EVM-EYS Series:

Specifications: • Rotation Torque: 20 to 300gf • Stopper Strength: 500gf • Rotation Angle: 210° ± 20°. • TCR: ±100ppm (-40°C - 120°C) • Nominal Total Resistance & Tolerance: ±20% • Power Rating and Maximum Operating Voltage: 0.5W, 200V (70°C) • Residual Resistance: 2% • Soldering Heat: 260°C ± 5°C for 5 ± 1 Second • Rotation Life: 50 turns

EVM-AAS Series:

Specifications: • Resistance Range: 1000 - 1mΩ • Tolerance: ±25% • Taper: Linear • Residual Resistance: 2% • Wattage Rating: 0.3W • Volt Rating: 100V • TCR: ±200ppm • Torque: 20 to 300gf • Stopper Strength: 350gf • Rotational Angle: 240°C ± 20°C • Operational Temperature: -30°C - 100°C

EVM-F6S Series:

Features: • Higher performance dustproof type • Excellent reliability for heat and humidity • High speed radial automatic mounting and excellent mounting performance

Applications: • Audio visual equipment, home appliances

Specifications: • Rotation Torque: 20 to 300gf • Stopper Strength: 350gf • Rotation Angle: 240°C ± 20°. • TCR: ±300ppm (-30°C - 100°C) • Nominal Total Resistance & Tolerance: ±25% • Power Rating & Maximum Operating Voltage: 0.3W, 100V (70°C) • Residual Resistance: 10Ω maximum for R<1kΩ, 1% maximum for 1kΩ<R<100kΩ, 5% maximum for R≥100kΩ • Soldering Heat: 5s maximum 240°C - 280°C, 3s maximum 280°C - 300°C • Rotation Life: 50 turns.

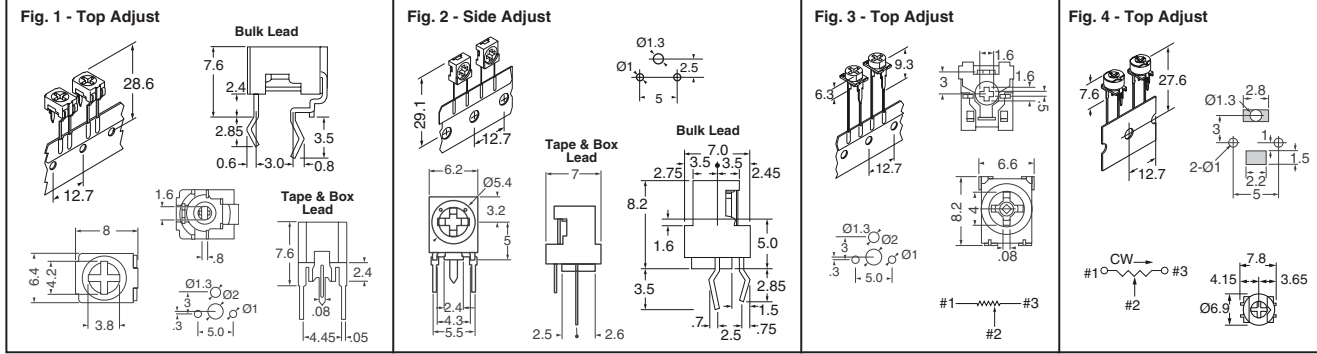

EVM-EAG Series — Top Adjust (Bulk)

Fig.	Res. (Ω)	Digi-Key Part No.	1	10	100	500	Panasonic Part No.
1	100	EAG12BK-ND	.73	6.05	55.66	242.00	EVM-EAGA00B12
	200	EAG22BK-ND	.73	6.05	55.66	242.00	EVM-EAGA00B22
	500	EAG52BK-ND	.73	6.05	55.66	242.00	EVM-EAGA00B52
	1K	EAG13BK-ND	.73	6.05	55.66	242.00	EVM-EAGA00B13
	2K	EAG23BK-ND	.73	6.05	55.66	242.00	EVM-EAGA00B23
	5K	EAG53BK-ND	.73	6.05	55.66	242.00	EVM-EAGA00B53
	10K	EAG14BK-ND	.73	6.05	55.66	242.00	EVM-EAGA00B14
	20K	EAG24BK-ND	.73	6.05	55.66	242.00	EVM-EAGA00B24
	50K	EAG54BK-ND	.73	6.05	55.66	242.00	EVM-EAGA00B54
	100K	EAG15BK-ND	.73	6.05	55.66	242.00	EVM-EAGA00B15
	200K	EAG25BK-ND	.73	6.05	55.66	242.00	EVM-EAGA00B25
	500K	EAG55BK-ND	.73	6.05	55.66	242.00	EVM-EAGA00B55
	1M	EAG16BK-ND	.73	6.05	55.66	242.00	EVM-EAGA00B16

EVM-EGG Series — Side Adjust (Bulk)

Fig.	Res. (Ω)	Digi-Key Part No.	1	10	100	500	Panasonic Part No.
2	100	EGG12BK-ND	.71	5.88	54.05	235.00	EVM-EGGA00B12
	200	EGG22BK-ND	.71	5.88	54.05	235.00	EVM-EGGA00B22
	500	EGG52BK-ND	.71	5.88	54.05	235.00	EVM-EGGA00B52
	1K	EGG13BK-ND	.71	5.88	54.05	235.00	EVM-EGGA00B13
	2K	EGG23BK-ND	.71	5.88	54.05	235.00	EVM-EGGA00B23
	5K	EGG53BK-ND	.71	5.88	54.05	235.00	EVM-EGGA00B53
	10K	EGG14BK-ND	.71	5.88	54.05	235.00	EVM-EGGA00B14
	20K	EGG24BK-ND	.71	5.88	54.05	235.00	EVM-EGGA00B24
	50K	EGG54BK-ND	.71	5.88	54.05	235.00	EVM-EGGA00B54
	100K	EGG15BK-ND	.71	5.88	54.05	235.00	EVM-EGGA00B15
	200K	EGG25BK-ND	.71	5.88	54.05	235.00	EVM-EGGA00B25
	500K	EGG55BK-ND	.71	5.88	54.05	235.00	EVM-EGGA00B55
	1M	EGG16BK-ND	.71	5.88	54.05	235.00	EVM-EGGA00B16

EVM-EAS Series — Top Adjust (Tape)

Fig.	Res. (Ω)	Digi-Key Part No.	Cut Tape Pricing			Digi-Key Part No.	Tape and Box Pricing		Panasonic Part No.
			1	10	100		1,000	5,000	
1	100	EAS12CT-ND	.71	5.88	54.05	EAS12TB-ND	362.00	336.00/M	EVM-EASA00B12
	200	EAS22CT-ND	.71	5.88	54.05	EAS22TB-ND	362.00	336.00/M	EVM-EASA00B22
	500	—	—	—	—	EAS52TB-ND	362.00	336.00/M	EVM-EASA00B52
	1K	EAS13CT-ND	.71	5.88	54.05	EAS13TB-ND	362.00	336.00/M	EVM-EASA00B13
	2K	EAS23CT-ND	.71	5.88	54.05	EAS23TB-ND	362.00	336.00/M	EVM-EASA00B23
	5K	EAS53CT-ND	.71	5.88	54.05	EAS53TB-ND	362.00	336.00/M	EVM-EASA00B53
	10K	—	—	—	—	EAS14TB-ND	362.00	336.00/M	EVM-EASA00B14
	20K	EAS24CT-ND	.71	5.88	54.05	EAS24TB-ND	362.00	336.00/M	EVM-EASA00B24
	50K	—	—	—	—	EAS54TB-ND	362.00	336.00/M	EVM-EASA00B54
	100K	—	—	—	—	EAS15TB-ND	362.00	336.00/M	EVM-EASA00B15
	200K	—	—	—	—	EAS25TB-ND	362.00	336.00/M	EVM-EASA00B25
	500K	EAS55CT-ND	.71	5.88	54.05	EAS55TB-ND	362.00	336.00/M	EVM-EASA00B55
	1M	EAS16CT-ND	.71	5.88	54.05	EAS16TB-ND	362.00	336.00/M	EVM-EASA00B16

EVM-EGS Series — Side Adjust (Tape)

Fig.	Res. (Ω)	Digi-Key Part No.	Cut Tape Pricing			Digi-Key Part No.	Tape and Box Pricing		Panasonic Part No.
			1	10	100		1,000	5,000	
2	100	EGS12CT-ND	.73	6.05	55.66	EGS12TB-ND	372.00	346.00/M	EVM-EGSA00B12
	200	EGS22CT-ND	.73	6.05	55.66	EGS22TB-ND	372.00	346.00/M	EVM-EGSA00B22
	500	EGS52CT-ND	.73	6.05	55.66	EGS52TB-ND	372.00	346.00/M	EVM-EGSA00B52
	1K	EGS13CT-ND	.73	6.05	55.66	EGS13TB-ND	372.00	346.00/M	EVM-EGSA00B13
	2K	EGS23CT-ND	.73	6.05	55.66	EGS23TB-ND	372.00	346.00/M	EVM-EGSA00B23
	5K	EGS53CT-ND	.73	6.05	55.66	EGS53TB-ND	372.00	346.00/M	EVM-EGSA00B53
	10K	—	—	—	—	EGS14TB-ND	372.00	346.00/M	EVM-EGSA00B14
	20K	EGS24CT-ND	.73	6.05	55.66	EGS24TB-ND	372.00	346.00/M	EVM-EGSA00B24
	50K	EGS54CT-ND	.73	6.05	55.66	EGS54TB-ND	372.00	346.00/M	EVM-EGSA00B54
	100K	—	—	—	—	EGS15TB-ND	372.00	346.00/M	EVM-EGSA00B15
	200K	—	—	—	—	EGS25TB-ND	372.00	346.00/M	EVM-EGSA00B25
	500K	EGS55CT-ND	.73	6.05	55.66	EGS55TB-ND	372.00	346.00/M	EVM-EGSA00B55
	1M	—	—	—	—	EGS16TB-ND	372.00	346.00/M	EVM-EGSA00B16

EVM-EYG Series — High Grade, Top Adjust (Bulk)

Fig.	Res. (Ω)	Digi-Key Part No.	1	10	100	500	Panasonic Part No.
1	2K	EYG23BK-ND	.79	6.58	60.49	263.00	EVM-EYGA00B23
	20K	EYG24BK-ND	.79	6.58	60.49	263.00	EVM-EYGA00B24
	50K	EYG54BK-ND	.79	6.58	60.49	263.00	EVM-EYGA00B54
	100K	EYG15BK-ND	.79	6.58	60.49	263.00	EVM-EYGA00B15
	200K	EYG25BK-ND	.79	6.58	60.49	263.00	EVM-EYGA00B25
	500K	EYG55BK-ND	.79	6.58	60.49	263.00	EVM-EYGA00B55
1M	EYG16BK-ND	.79	6.58	60.49	263.00	EVM-EYGA00B16	

EVM-F6S Series — Top Adjust (Tape)

Fig.	Res. (Ω)	Digi-Key Part No.	Cut Tape Pricing			Digi-Key Part No.	Tape and Box Pricing		Panasonic Part No.
			1	10	100		1,000	5,000	
3	1K	—	—	—	—	F6SA13TB-ND	213.00	197.00/M	EVM-F6SA00B13
	50K	F6SA54CT-ND	.38	3.28	27.20	—	—	—	EVM-F6SA00B54
	200K	F6SA25CT-ND	.38	3.28	27.20	—	—	—	EVM-F6SA00B25
	500K	F6SA55CT-ND	.38	3.28	27.20	F6SA55TB-ND	213.00	197.00/M	EVM-F6SA00B55

EVM-EYS Series — High Grade, Top Adjust (Tape)

Fig.	Res. (Ω)	Digi-Key Part No.	Tape and Box Pricing			Panasonic Part No.
			1,000	5,000	10,000	
1	2K	EYS23TB-ND	405.00	375.00/M	351.00/M	EVM-EYSA00B23
	5K	EYS53TB-ND	405.00	375.00/M	351.00/M	EVM-EYSA00B53
	10K	EYS14TB-ND	405.00	375.00/M	351.00/M	EVM-EYSA00B14
	20K	EYS24TB-ND	405.00	375.00/M	351.00/M	EVM-EYSA00B24
	50K	EYS54TB-ND	405.00	375.00/M	351.00/M	EVM-EYSA00B54
	200K	EYS25TB-ND	405.00	375.00/M	351.00/M	EVM-EYSA00B25
	500K	EYS55TB-ND	405.00	375.00/M	351.00/M	EVM-EYSA00B55
	1M	EYS16TB-ND	405.00	375.00/M	351.00/M	EVM-EYSA00B16

EVM-AAS Series — Top Adjust (Tape)

Fig.	Res. (Ω)	Digi-Key Part No.	Cut Tape Pricing			Digi-Key Part No.	Tape & Box Pricing		Panasonic Part No.
			1	10	100		1,000	5,000	
4	100	AAS12CT-ND	.50	4.15	38.18	AAS12TB-ND	255.00	255.00	EVM-AASA00B12
	200	AAS22CT-ND	.50	4.15	38.18	AAS22TB-ND	255.00	255.00	EVM-AASA00B22
	500	AAS52CT-ND	.50	4.15	38.18	AAS52TB-ND	255.00	255.00	EVM-AASA00B52
	1K	AAS13CT-ND	.50	4.15	38.18	AAS13TB-ND	255.00	255.00	EVM-AASA00B13
	2K	AAS23CT-ND	.50	4.15	38.18	AAS23TB-ND	255.00	255.00	EVM-AASA00B23
	5K	AAS53CT-ND	.50	4.15	38.18	AAS53TB-ND	255.00	255.00	EVM-AASA00B53
	10K	AAS14CT-ND	.50	4.15	38.18	AAS14TB-ND	255.00	255.00	EVM-AASA00B14
	20K	AAS24CT-ND	.50	4.15	38.18	AAS24TB-ND	255.00	255.00	EVM-AASA00B24
	50K	AAS54CT-ND	.50	4.15	38.18	AAS54TB-ND	255.00	255.00	EVM-AASA00B54
	100K	AAS15CT-ND	.50	4.15	38.18	AAS15TB-ND	255.00	255.00	EVM-AASA00B15
	200K	AAS25CT-ND	.50	4.15	38.18	AAS25TB-ND	255.00	255.00	EVM-AASA00B25
	500K	AAS55CT-ND	.50	4.15	38.18	AAS55TB-ND	255.00	255.00	EVM-AASA00B55
	1M	AAS16CT-ND	.50	4.15	38.18	AAS16TB-ND	255.00	255.00	EVM-AASA00B16

• RoHS Compliant

More Product Available Online: www.digikey.com

Toll-Free: 1-800-344-4539 • Phone 218-681-6674 • Fax: 218-681-3380

Panasonic[®] Ceramic Trimmer Potentiometers

Series EVM-L4G, EVM-L1G, EVM-5AG, and EVM-4LG

Specifications:

• Resistance Range: 100Ω to 1MΩ • Taper: Linear • Tolerance: 25% • Residual: EVM-L4G and EVM-L1G: 5%; EVM-5AG and EVM-4LG: 2% • Wattage Rating: EVM-L4G and EVM-L1G: .2W; EVM-5AG and EVM-4LG: .3W • Voltage Rating: EVM-L4G and EVM-L1G: 50V; EVM-5AG and EVM-4LG: 100V • TCR: EVM-L4G and EVM-L1G: ±300ppm; EVM-5AG and EVM-4LG: ±200ppm • Torque: 20-250 gf • Stopper Strength: EVM-L4G and EVM-L1G: 400gf; EVM-5AG and EVM-4LG: 300gf • Angle of Rotation: 200° ±20° • Operating Temperature: -30°C - 100°C

Fig. 1 — 4mm, Vertical

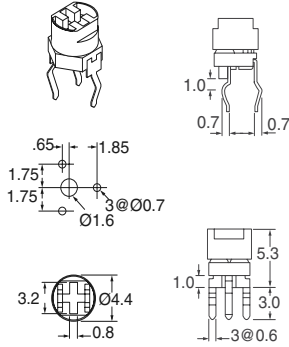

Fig. 2 — 4mm, Right Angle

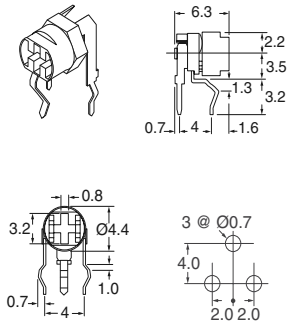

Fig. 3 — 5mm, Vertical

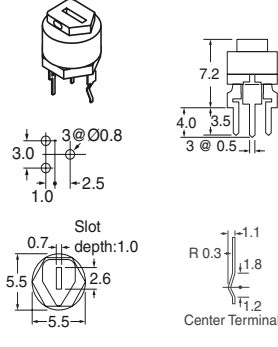

Fig. 4 — 6mm, Vertical

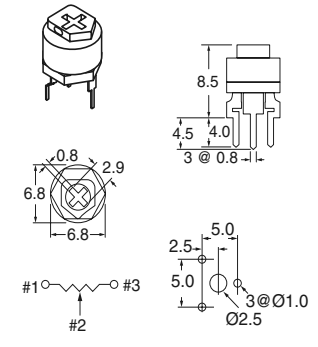
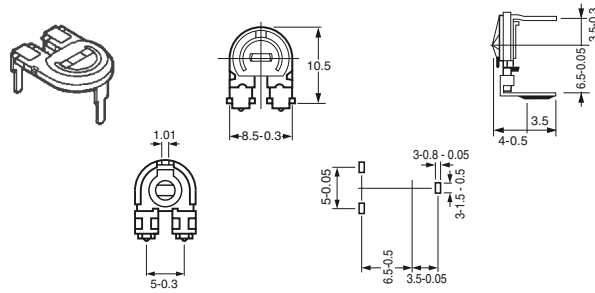

Fig.	Res. (Ω)	Digi-Key Part No.	Pricing				Panasonic Part No.
			1	10	100	500	
EVM-L4G Series — 4mm, Vertical, Top Adjust							
1	2K	L4G23BK-ND	.54	5.01	41.12	192.75	EVM-L4GA00B23
	10K	L4G14BK-ND	.54	5.01	41.12	192.75	EVM-L4GA00B14
	100K	L4G15BK-ND	.54	5.01	41.12	192.75	EVM-L4GA00B15
	200K	L4G25BK-ND	.54	5.01	41.12	192.75	EVM-L4GA00B25
	500K	L4G55BK-ND	.54	5.01	41.12	192.75	EVM-L4GA00B55
	1M	L4G16BK-ND	.54	5.01	41.12	192.75	EVM-L4GA00B16
EVM-L1G Series — 4mm, Right Angle, Side Adjust							
2	100	L1G12BK-ND	.58	5.36	44.00	206.25	EVM-L1GA00B12
	200	L1G22BK-ND	.58	5.36	44.00	206.25	EVM-L1GA00B22
	500	L1G52BK-ND	.58	5.36	44.00	206.25	EVM-L1GA00B52
	1K	L1G13BK-ND	.58	5.36	44.00	206.25	EVM-L1GA00B13

Fig.	Res. (Ω)	Digi-Key Part No.	Pricing				Panasonic Part No.
			1	10	100	500	
2	5K	L1G53BK-ND	.58	5.36	44.00	206.25	EVM-L1GA00B53
	10K	L1G14BK-ND	.58	5.36	44.00	206.25	EVM-L1GA00B14
	20K	L1G24BK-ND	.83	6.88	63.25	275.00	EVM-L1GA00B24
	100K	L1G15BK-ND	.58	5.36	44.00	206.25	EVM-L1GA00B15
	200K	L1G25BK-ND	.58	5.36	44.00	206.25	EVM-L1GA00B25
	1M	L1G16BK-ND	.58	5.36	44.00	206.25	EVM-L1GA00B16
EVM-5AG Series — 5mm, Vertical, Top Adjust							
3	100K	5AG15BK-ND	.50	4.64	38.08	178.50	EVM-5AGA00B15
	200K	5AG25BK-ND	.50	4.64	38.08	178.50	EVM-5AGA00B25
EVM-4LG Series — 6mm, Vertical, Top Adjust							
4	100	4LG12BK-ND	.41	3.84	31.52	147.75	EVM-4LGA00B12
	500K	4LG55BK-ND	.41	3.84	31.52	147.75	EVM-4LGA00B55

8mm Trimmer Potentiometers EVN-Series

K4A Series



K0A Series

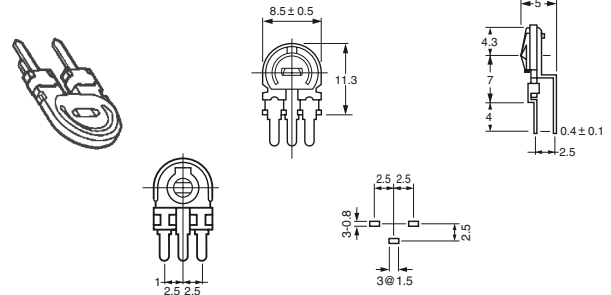

Specifications:

• Resistance Range: 300 to 2MΩ • Taper: Linear • Tolerance: ±30% • Working Voltage: 200V maximum • Power Rating: 0.1 W/50°C • Residual Resistance: Up to 1kΩ: 10Ω maximum Over 1kΩ: 5% of total resistance • Rotation Angle: 260° ± 20° • Rotation Torque: 0.4 to 4.2 in.-oz. • Stop Strength: 1 inch/pound • Operating Temperature: -25°C - 75°C

Res. (Ω)	Digi-Key Part No. Laydown Version	Digi-Key Part No. Standup Version	Pricing						Panasonic Part No. Laydown Version	Panasonic Part No. Standup Version
			1	10	100	1,000	5,000	10,000		
300	—	K0A32-ND	.22	2.02	16.56	144.90	—	—	—	EVN-64AA00B32
2K	K4A23-ND	K0A23-ND	.22	2.02	16.56	144.90	134.55/M	124.20/M	EVN-65AA00B23	EVN-64AA00B23

More Product Available Online: www.digkey.com

Toll-Free: 1-800-344-4539 • Phone 218-681-6674 • Fax: 218-681-3380



6mm Carbon Trimmer Potentiometers

SPECIFICATIONS:

Mechanical: • Rotation Angle: 210° ±20° • Rotation Torque: 20 – 250g-cm • Stopper Strength: 750gfcm • Soldering Heat: 240°C – 280°C, 5 seconds maximum; 280°C – 300°C, 3 seconds maximum • Rotation life: 100 cycles

Electrical: • Power rating: 0.1W (when under 50°C) • Maximum operating voltage: 50V • Taper: B (Linear) • Resistance: 200Ω – 1MΩ • Tolerance: ±30%.

FEATURES:

• Miniature size, lightweight, 6.4 x 6.7mm • Suitable for automatic insertion as square housing • Suitable for automatic adjustment as stable rotation torque • Dust proof and flux proof construction • Adjustable from both top and bottom sides • Snap-in mounting terminal for EVN-D8A/D2A

Applications: • Consumer equipment such as TV, VTR (VCR), stereo, radio.



Carbon Trimmer Potentiometers



Digi-Key® Assortment Kit
14 Panasonic 6mm Carbon Trimmer Potentiometers
Panasonic Quality

Cat. No. **DXA-KIT-ND**..... **\$29.95**

140 6mm Carbon Trimmer Potentiometers: Price includes convenient divided notebook style storage case with bin guide for easy storage and quick access.

EVN-D2A (Side Adjust)

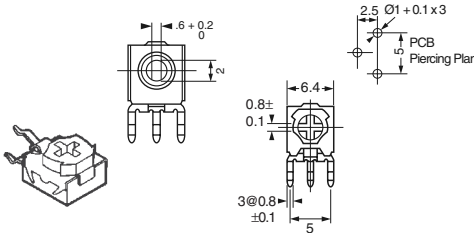

EVN-D8A (Top Adjust)

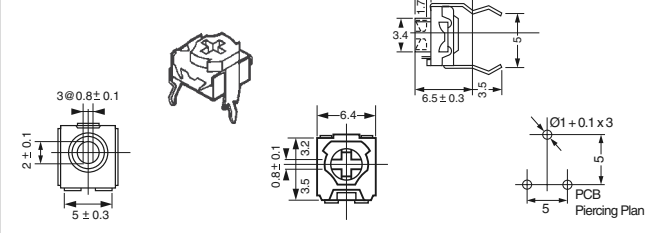

EVN-DCA (Side Adjust)

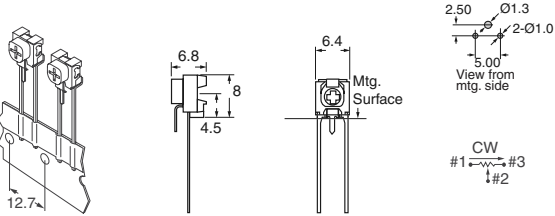

EVN-DJA (Top Adjust)

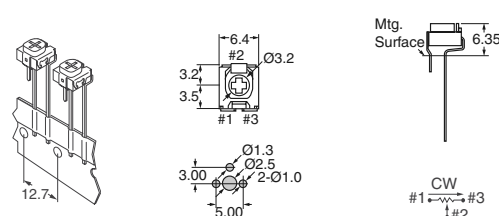

EVN-D2A Side Adjust (Bulk) Series — EVN-D8A Top Adjust (Bulk) Series

Resistance (Ω)	Digi-Key Part No. Side Adjust Version	Digi-Key Part No. Top Adjust Version	Bulk Pricing				Panasonic Part No. Side Adjust Version	Panasonic Part No. Top Adjust Version	
			1	10	100	500			1,000
200	D1AA22-ND*	D4AA22-ND*	.36	2.63	19.44	72.90	113.40	EVN-D2AA03B22	EVN-D8AA03B22
500	D1AA52-ND*	D4AA52-ND*	.36	2.63	19.44	72.90	113.40	EVN-D2AA03B52	EVN-D8AA03B52
1K	D1AA13-ND*	D4AA13-ND*	.36	2.63	19.44	72.90	113.40	EVN-D2AA03B13	EVN-D8AA03B13
2K	D1AA23-ND	D4AA23-ND	.36	2.63	19.44	72.90	113.40	EVN-D2AA03B23	EVN-D8AA03B23
5K	D1AA53-ND*	D4AA53-ND*	.36	2.63	19.44	72.90	113.40	EVN-D2AA03B53	EVN-D8AA03B53
10K	D1AA14-ND	D4AA14-ND	.36	2.63	19.44	72.90	113.40	EVN-D2AA03B14	EVN-D8AA03B14
20K	D1AA24-ND*	D4AA24-ND	.36	2.63	19.44	72.90	113.40	EVN-D2AA03B24	EVN-D8AA03B24
50K	D1AA54-ND*	D4AA54-ND	.36	2.63	19.44	72.90	113.40	EVN-D2AA03B54	EVN-D8AA03B54
100K	D1AA15-ND*	D4AA15-ND*	.36	2.63	19.44	72.90	113.40	EVN-D2AA03B15	EVN-D8AA03B15
200K	D1AA25-ND*	D4AA25-ND	.36	2.63	19.44	72.90	113.40	EVN-D2AA03B25	EVN-D8AA03B25
500K	D1AA55-ND*	D4AA55-ND*	.36	2.63	19.44	72.90	113.40	EVN-D2AA03B55	EVN-D8AA03B55

◆ RoHS Compliant * Denotes part included in DXA-KIT.

EVN-DCA Side Adjust (Tape) Series — EVN-DJA Top Adjust (Tape) Series

Res. (Ω)	Digi-Key Part No. Side Adjust Version	Digi-Key Part No. Top Adjust Version	Cut Tape Pricing				Digi-Key Part No. Side Adjust Version	Digi-Key Part No. Top Adjust Version	Tape & Box Pricing 1,000	Panasonic Part No. Side Adjust Version	Panasonic Part No. Top Adjust Version
			1	10	100	500					
200	DCA22CT-ND	DJA22CT-ND	.41	2.99	22.08	82.80	DCA22TB-ND	DJA22TB-ND	129.00	EVN-DCAA03B22	EVN-DJAA03B22
500	DCA52CT-ND	DJA52CT-ND	.41	2.99	22.08	82.80	DCA52TB-ND	DJA52TB-ND	129.00	EVN-DCAA03B52	EVN-DJAA03B52
1K	DCA13CT-ND	DJA13CT-ND	.41	2.99	22.08	82.80	DCA13TB-ND	DJA13TB-ND	129.00	EVN-DCAA03B13	EVN-DJAA03B13
2K	DCA23CT-ND	DJA23CT-ND	.41	2.99	22.08	82.80	DCA23TB-ND	DJA23TB-ND	129.00	EVN-DCAA03B23	EVN-DJAA03B23
5K	DCA53CT-ND	DJA53CT-ND	.41	2.99	22.08	82.80	DCA53TB-ND	DJA53TB-ND	129.00	EVN-DCAA03B53	EVN-DJAA03B53
10K	DCA14CT-ND	DJA14CT-ND	.41	2.99	22.08	82.80	DCA14TB-ND	DJA14TB-ND	129.00	EVN-DCAA03B14	EVN-DJAA03B14
20K	DCA24CT-ND	DJA24CT-ND	.41	2.99	22.08	82.80	DCA24TB-ND	DJA24TB-ND	129.00	EVN-DCAA03B24	EVN-DJAA03B24
50K	DCA54CT-ND	DJA54CT-ND	.41	2.99	22.08	82.80	DCA54TB-ND	DJA54TB-ND	129.00	EVN-DCAA03B54	EVN-DJAA03B54
100K	DCA15CT-ND	DJA15CT-ND	.41	2.99	22.08	82.80	DCA15TB-ND	DJA15TB-ND	129.00	EVN-DCAA03B15	EVN-DJAA03B15
200K	DCA25CT-ND	DJA25CT-ND	.41	2.99	22.08	82.80	DCA25TB-ND	DJA25TB-ND	129.00	EVN-DCAA03B25	EVN-DJAA03B25
500K	DCA55CT-ND	DJA55CT-ND	.41	2.99	22.08	82.80	DCA55TB-ND	DJA55TB-ND	129.00	EVN-DCAA03B55	EVN-DJAA03B55

◆ RoHS Compliant



Cermet Series Trimmer Potentiometers 6mm Diameter Cermet Dust-Proof Type

EVM-31GA

(Horizontal Both Sides Adjust)

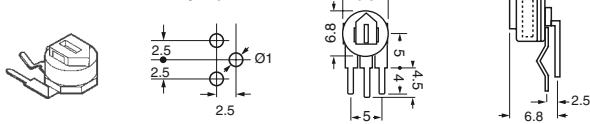

SPECIFICATIONS: • Resistance Range: 100 to 500K • Tolerance: ±25% • Taper: Linear • Residual Resistance: 5% maximum • Wattage Rating: 0.3W maximum (70°C) • Voltage Rating: 100V maximum • TCR: +200PPM/°C • Rotation Torque: 20 to 250g-cm • Stopper Strength: 300g-cm minimum • Rotation Angle: 200° ±20° • Operating Temperature: -40°C – 101°C (EVM-31G/36G)

Resistance Ω	Digi-Key Part No. Horizontal—31GA	Pricing			Panasonic Part No. Horizontal—31G
		1	10	100	
100	31G12-ND	.67	5.28	46.08	EVM-31GA00B12
500K	31G55-ND	.67	5.28	46.08	EVM-31GA00B55

More Product Available Online: www.digkey.com

Toll-Free: 1-800-344-4539 • Phone 218-681-6674 • Fax: 218-681-3380

(T083) 1905