

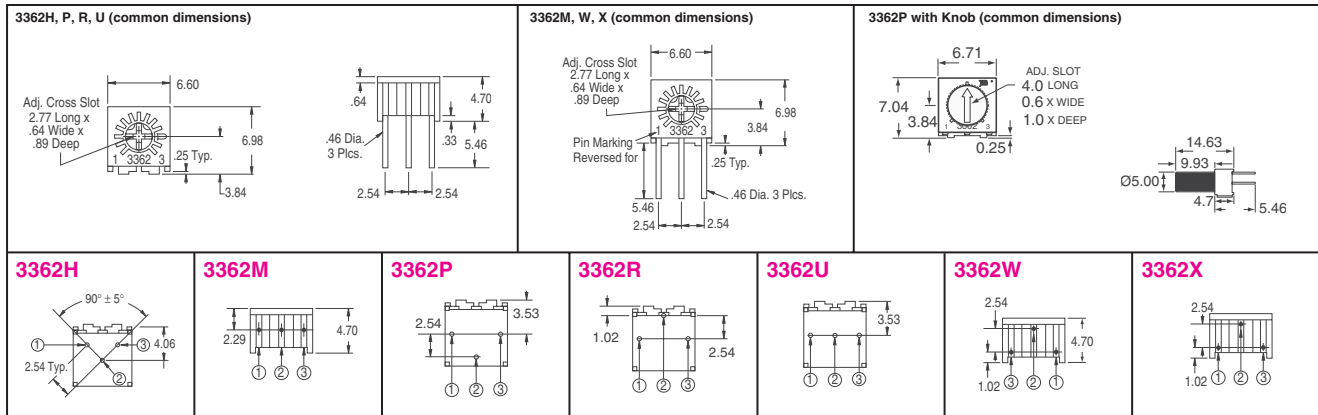

Trimmer Potentiometers

SERIES 3362 — 1/4" (6.35mm) Square/Single-Turn Cermet/Industrial/Sealed

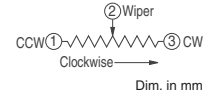

Res. (Ω)	Digi-Key Part No.	Digi-Key Part No.	Digi-Key Part No.	Digi-Key Part No.	Digi-Key Part No.	Digi-Key Part No.	Digi-Key Part No.	Digi-Key Part No.
100	3362H-101LF-ND	3362M-101LF-ND	3362P-101-ND	—	3362R-101-ND	3362U-101-ND	3362W-101-ND	3362X-101LF-ND
200	3362H-201LF-ND	3362M-201-ND	3362P-201-ND	3362R-201-ND	3362U-201LF-ND	3362W-201LF-ND	3362X-201LF-ND	—
500	3362H-501LF-ND	3362M-501-ND	3362P-501-ND	3362R-501LF-ND	3362U-501-ND	3362W-501LF-ND	3362X-501LF-ND	—
1K	3362H-102LF-ND	3362M-102-ND	3362P-102LF-ND	3362R-102LF-ND	3362U-102-ND	3362W-102LF-ND	3362X-102-ND	—
2K	3362H-202-ND	3362M-202LF-ND	3362P-202LF-ND	3362R-202LF-ND	3362U-202-ND	3362W-202LF-ND	3362X-202LF-ND	3362P-202TLF-ND
5K	3362H-502LF-ND	3362M-502LF-ND	3362P-502LF-ND	3362R-502LF-ND	3362U-502-ND	3362W-502LF-ND	3362X-502LF-ND	3362P-502TLF-ND
10K	3362H-103LF-ND	3362M-103LF-ND	3362P-103LF-ND	3362R-103LF-ND	3362U-103LF-ND	3362W-103-ND	3362X-103LF-ND	3362P-103TLF-ND
20K	3362H-203LF-ND	3362M-203-ND	3362P-203LF-ND	3362R-203LF-ND	3362U-203LF-ND	3362W-203LF-ND	3362X-203-ND	3362P-203TLF-ND
25K	3362H-253LF-ND	3362M-253LF-ND	3362P-253LF-ND	3362R-253-ND	3362U-253LF-ND	3362W-253LF-ND	3362X-253LF-ND	—
50K	3362H-503LF-ND	3362M-503LF-ND	3362P-503LF-ND	3362R-503LF-ND	3362U-503-ND	3362W-503LF-ND	—	3362P-503TLF-ND
100K	3362H-104LF-ND	3362M-104LF-ND	3362P-104LF-ND	3362R-104LF-ND	3362U-104LF-ND	3362W-104LF-ND	3362X-104LF-ND	—
200K	3362H-204LF-ND	—	3362P-204LF-ND	3362R-204LF-ND	3362U-204LF-ND	3362W-204LF-ND	3362X-204-ND	—
500K	3362H-504LF-ND	3362M-504LF-ND	3362P-504LF-ND	3362R-504LF-ND	3362U-504-ND	3362W-504-ND	3362X-504-ND	—
1M	3362H-105-ND	3362M-105-ND	3362P-105LF-ND	3362R-105-ND	3362U-105LF-ND	3362W-105-ND	3362X-105LF-ND	—

Features: • Miniature package • Rotor designed for automatic machine adjust interface • Multi-wire wiper to minimize CRV • Withstands harsh environments and immersion cleaning process
Characteristics: • Resistance Tolerance: ±10% standard • Insulation Resistance: 500VDC 1,000MΩ minimum • Adjustment Angle: 240° nominal • Power Rating (300V max.): 70°C = 0.5W; 125°C = 0W
 • Temperature Range: -55°C - 125°C • Temperature Coefficient: ±100ppm/°C • Load Life: 1,000 hours 0.5W @ 70°C (3% ΔTR; CRV, 3% or 3Ω whichever is greater) • Rotational Life: 200 cycles (4% ΔTR; CRV, 3% or 3Ω, whichever is greater) • Mechanical Angle: 270° nominal • Torque: 3.0 oz-inch maximum • Stop Strength: 7.0 oz-inch minimum

Series	Pricing		
	1	10	50
3362H / 3362M / 3362P / 3362R / 3362U / 3362W / 3362X	.83	7.50	36.75
3362P (with Knob)	1.51	13.75	59.13

♦ RoHS Compliant † For RoHS Compliant Part Number change -ND to LF-ND

SERIES 3313 — 3mm Trimming Potentiometer

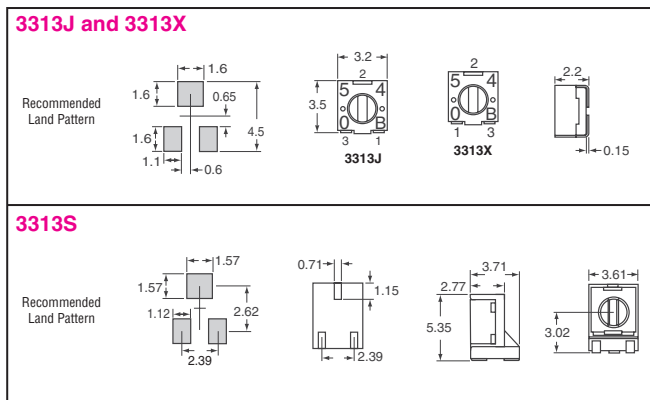

Feature: • Surface Mount 3mm Square Single-Turn Cermet/Sealed

Characteristics: • Resistance Tolerance: ±20% standard • End Resistance: 1% or 3Ω maximum (whichever is greater) • Contact Resistance Variation: 3% or 3Ω • Insulation Resistance: 500VDC, 100MΩ minimum • Adjustment Angle: 220° nominal • Dielectric Strength: Sea level: 500VAC; 70,000 Feet: 350VAC • Power Rating (200V max.): 70°C = 0.125W; 125°C = 0W • Temperature Range: -55°C - 125°C • Temperature Coefficient: ≤100Ω ±150ppm/°C; >100Ω ±100ppm/°C

Resolution (Ω)	Digi-Key Part No.	Digi-Key Part No.	Digi-Key Part No.
10	3313J-1-100E□□-ND NEW!	3313S-1-100E□□-ND NEW!	—
20	3313J-1-200E□□-ND NEW!	3313S-1-200E□□-ND NEW!	—
50	3313J-1-500E□□-ND NEW!	3313S-1-500E□□-ND NEW!	—
100	3313J-101E□□-ND	3313S-1-101E□□-ND NEW!	—
200	3313J-201E□□-ND	3313S-1-201E□□-ND NEW!	—
500	3313J-501E□□-ND	3313S-1-501E□□-ND NEW!	—
1K	3313J-102E□□-ND	3313S-102E□□-ND	—
2K	3313J-202E□□-ND	3313S-1-202E□□-ND NEW!	—
5K	3313J-502E□□-ND	3313S-1-502E□□-ND NEW!	3313X-502E□□-ND
10K	3313J-103E□□-ND	3313S-103E□□-ND	3313X-103E□□-ND
20K	3313J-203E□□-ND	3313S-203E□□-ND	3313X-203E□□-ND
50K	3313J-503E□□-ND	3313S-1-503E□□-ND NEW!	3313X-503E□□-ND
100K	3313J-104E□□-ND	3313S-1-104E□□-ND NEW!	—
200K	3313J-1-204E□□-ND NEW!	3313S-1-204E□□-ND NEW!	—
500K	3313J-1-504E□□-ND NEW!	3313S-1-504E□□-ND NEW!	—
1MEG	3313J-1-105E□□-ND NEW!	3313S-105E□□-ND	—
2MEG	3313J-1-205E□□-ND NEW!	3313S-1-205E□□-ND NEW!	—

Series	Part No.	Cut Tape Pricing			Part No.	Tape and Reel Pricing	
		1	10	100		200	1,000
3313J/3313J-1	Add "CT"-ND	1.80	15.00	138.00	Add "TR"-ND	—	900.00
3313S/3313S-1	Add "CT"-ND	1.98	16.50	151.80	Add "TR"-ND	244.20	—
3313X	Add "CT"-ND	1.86	15.50	142.60	Add "TR"-ND	—	992.00

♦ RoHS Compliant

Digi-Reel® Most SMT cutdown parts are available on a Digi-Reel®. For Digi-Reel part number, change 1-ND to 6-ND or CT-ND to DKR-ND. See Digi-Key® Services on page 2 for additional information.

More Product Available Online: www.digkey.com

Toll-Free: 1-800-344-4539 • Phone 218-681-6674 • Fax: 218-681-3380

(T083) 1879



Trimmer Potentiometers

SERIES 3302 — 2mm SMD, Trimming Potentiometer 3302W, X

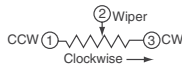

3 Terminals for Automatic Trimming Adjustment Low Profile

Dim. in mm

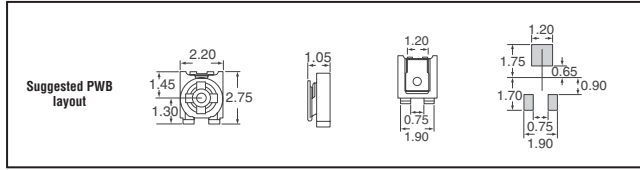

Feature: • Single-Turn Cermet / Open Frame
Characteristics: • Resistance Tolerance: ±25% standard • Contact Resistance Variation: 5% maximum • Resolution: Infinite • Adjustment Angle: 260° ±20° • Power Rating (50VDC maximum): 70°C = 0.15W • Temperature Range: -40°C - 85°C • Temperature Coefficient: ±25ppm/°C • TRS maximum: ±5%

Res. (Ω)	Digi-Key Part No.	Digi-Key Part No.
2K	3302W-202E□-ND	—
5K	3302W-502E□-ND	3302X-502E□-ND
10K	3302W-103E□-ND	3302X-103E□-ND
20K	3302W-203E□-ND	3302X-203E□-ND

Series	Part No.	Cut Tape Pricing		Part No.	Tape and Reel Pricing	
		10	100		3,000	3,000
3302W	Add "CT-ND"	45	3.75	34.50	Add "TR-ND"	225.00/M
3302X	Add "CT-ND"	45	3.75	34.50	Add "TR-ND"	225.00/M

◆ RoHS Compliant

SERIES 3260 — 1/4"(6.35mm) Square/Multiturn (11) Wirewound/Industrial/Sealed

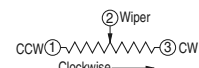

Dim. in mm

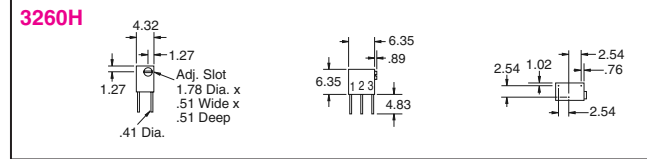

3260H

Characteristics:
 • Resistance Tolerance: ±5% standard • Insulation Resistance: 500VDC 1,000MΩ minimum • Adjustment Angle: 11 turns nominal • Power Rating: 85°C = 0.25W; 150°C = 0W • Temperature Range: -65°C - 150°C • Temperature Coefficient: 70ppm/°C • Load Life: 1,000 hours 0.25W @ 85°C (2% DTR; ENR, 500Ω) • Rotational Life: 200 cycles (2% DTR; ENR, 500Ω) • Torque: 3.0 oz-inch maximum • Mechanical Stops: Wiper idles

Res. (Ω)	Digi-Key Part No.	Nominal Resolution (Percent)
100	3260H-101-ND	1.00
200	3260H-201-ND	0.94
500	3260H-501-ND	0.58
1K	3260H-102-ND	0.50
2K	3260H-202-ND	0.45
10K	3260H-103-ND	0.29
20K	3260H-203-ND	0.28

Series	1	Pricing	
		10	50
3260H	28.52	259.25	1114.78

◆ RoHS Compliant

SERIES 3386 — 3/8" (9.52mm) Square/Single-Turn Cermet/Industrial/Sealed

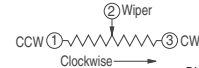

Dim. in mm

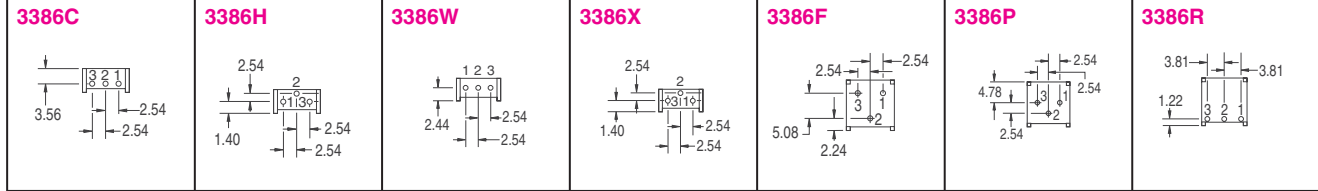
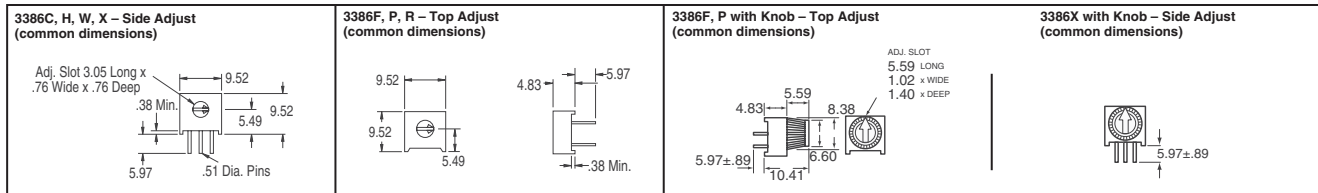

Res. (Ω)	3386C, H, W, X				3386F, P, R			3386F, P, X with Knob		
	Digi-Key Part No.	Digi-Key Part No.	Digi-Key Part No.	Digi-Key Part No.	Digi-Key Part No.	Digi-Key Part No.	Digi-Key Part No.	Digi-Key Part No.	Digi-Key Part No.	Digi-Key Part No.
50	3386C-500LF-ND	3386H-500LF-ND	3386W-500-ND	3386X-500LF-ND	3386F-500LF-ND	3386F-500LF-ND	—	—	—	—
100	3386C-101LF-ND	3386H-101LF-ND	3386W-101LF-ND	3386X-101LF-ND	3386F-101LF-ND	3386F-101LF-ND	3386R-101LF-ND	—	—	—
200	3386C-201-ND	3386H-201LF-ND	3386W-201LF-ND	3386X-201LF-ND	3386F-201LF-ND	3386F-201LF-ND	—	—	—	—
500	3386C-501LF-ND	3386H-501-ND	3386W-501-ND	3386X-501LF-ND	3386F-501LF-ND	3386F-501LF-ND	—	—	—	—
1K	3386C-102LF-ND	3386H-102LF-ND	3386W-102LF-ND	3386X-102-ND	3386F-102LF-ND	3386F-102LF-ND	—	—	—	3386P-102TLF-ND
2K	3386C-202LF-ND	3386H-202LF-ND	3386W-202LF-ND	3386X-202LF-ND	3386F-202LF-ND	3386F-202LF-ND	3386R-202-ND	—	—	—
5K	3386C-502LF-ND	3386H-502LF-ND	3386W-502LF-ND	3386X-502LF-ND	3386F-502LF-ND	3386F-502LF-ND	3386R-502LF-ND	3386F-502TLF-ND	3386P-502TLF-ND	3386X-502TLF-ND
10K	3386C-103LF-ND	3386H-103LF-ND	3386W-103LF-ND	3386X-103LF-ND	3386F-103-ND	3386F-103LF-ND	3386R-103LF-ND	3386F-103TLF-ND	3386P-103TLF-ND	3386X-103TLF-ND
20K	3386C-203LF-ND	3386H-203LF-ND	3386W-203LF-ND	—	3386F-203LF-ND	3386P-203LF-ND	3386R-203LF-ND	3386F-203TLF-ND	3386P-203TLF-ND	—
25K	3386C-253-ND	3386H-253-ND	3386W-253LF-ND	3386X-253LF-ND	3386F-253LF-ND	3386P-253LF-ND	3386R-253LF-ND	—	—	—
50K	3386C-503-ND	3386H-503LF-ND	3386W-503LF-ND	3386X-503LF-ND	3386F-503LF-ND	3386P-503LF-ND	—	—	—	3386P-503TLF-ND
100K	3386C-104LF-ND	3386H-104LF-ND	3386W-104LF-ND	3386X-104LF-ND	3386F-104LF-ND	3386P-104LF-ND	3386R-104LF-ND	—	—	3386P-104TLF-ND
200K	3386C-204LF-ND	3386H-204-ND	—	3386X-204-ND	3386F-204-ND	3386P-204LF-ND	3386R-204-ND	—	—	—
250K	3386C-254LF-ND	—	3386W-254-ND	—	3386F-254-ND	—	—	—	—	—
500K	3386C-504-ND	3386H-504LF-ND	3386W-504LF-ND	3386X-504LF-ND	3386F-504LF-ND	3386P-504LF-ND	3386R-504LF-ND	—	—	—
1M	3386C-105LF-ND	3386H-105-ND	3386W-105LF-ND	3386X-105LF-ND	3386F-105LF-ND	3386P-105LF-ND	3386R-105-ND	—	—	—
2M	3386C-205-ND	3386H-205-ND	3386W-205LF-ND	3386X-205LF-ND	3386F-205LF-ND	3386P-205LF-ND	3386R-205-ND	—	—	—

Characteristics:
 • Resistance Tolerance: ±10% standard • Insulation Resistance: 500VDC 1,000MΩ minimum • Adjustment Angle: 280° • Power Rating (300V max.): 85°C = 0.5W; 125°C = 0W • Temperature Range: -55°C - 125°C • Temperature Coefficient: ±100ppm/°C • Load Life: 1,000 hours 0.5W @ 70°C (3% ΔTR; CRV, 1% or 1Ω, whichever is greater) • Rotational Life: 200 cycles (4% ΔTR; CRV, 1% or 1Ω, whichever is greater) • Mechanical Angle: 310° nominal • Torque: 5.0 oz-inch maximum • Stop Strength: 15.0 oz-inch minimum

Series	Pricing		
	1	10	50
3386C/3386R	1.43	13.00	55.90
3386F/3386H/3386P/3386W/3386X	1.29	11.75	50.53
3386F/3386P/3386X (with Knob)	2.06	15.75	69.38

◆ RoHS Compliant † For RoHS Compliant Part Number change -ND to LF-ND.

More Product Available Online: www.digkey.com

1880 (T083)

Toll-Free: 1-800-344-4539 • Phone 218-681-6674 • Fax: 218-681-3380



Trimmer Potentiometers

SERIES 3009 — 3/4" (19.05mm) Rectangular/ Multiturn (15) Cermet/ Industrial/ Sealed

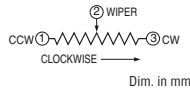

Characteristics: • Resistance Tolerance: ±10% standard
• Insulation Resistance: 500VDC 1,000MΩ minimum
• Adjustment Travel: 15 turns nominal • Temperature Coefficient: ±100ppm/°C • Load Life: 1,000 hours 0.75W @ 70°C (4% ΔTR) • Rotational Life: 200 cycles (3% ΔTR; CRV, 1% or 1Q, whichever is greater) • Torque: 5.0 oz-inch maximum
• Mechanical Stops: Wiper idles

Res. (Ω)	Digi-Key Part No.	Digi-Key Part No.
100	3009P-101LF-ND	3009Y-201-ND
200	3009P-201LF-ND	3009Y-501-ND†
500	3009P-501LF-ND	3009Y-102LF-ND
1K	3009P-102LF-ND	3009Y-202LF-ND
2K	3009P-202LF-ND	3009Y-502LF-ND
5K	3009P-502LF-ND	3009Y-103LF-ND
10K	3009P-103LF-ND	3009Y-203LF-ND
20K	3009P-203LF-ND	3009Y-503LF-ND
25K	3009P-253LF-ND	3009Y-503-ND†
50K	3009P-503LF-ND	3009Y-104LF-ND
100K	3009P-104LF-ND	3009Y-104-ND†
200K	3009P-204LF-ND	—
500K	3009P-504LF-ND	3009Y-504-ND†
1M	3009P-105LF-ND	3009Y-105-ND

Series	1	Pricing 10	50
3009P/3009Y	2.72	24.75	106.43

◆ RoHS Compliant † For RoHS Compliant Part Number change -ND to LF-ND

SERIES 3266 — 1/4" (6.35mm) Square/ Multiturn (12) Cermet/Industrial/Sealed

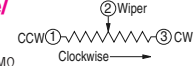

• Resistance Tolerance: ±10% standard • Insulation Resistance: 500VDC 1,000MΩ minimum • Effective Travel: 12 turns nominal • Power Rating (300 volts maximum): 70°C - 0.25 watt; 150°C - 0 watt • Temperature Range: -55°C - 125°C • Temperature Coefficient: ±100ppm/°C • Load Life: 1,000 hours 0.25 watt @ 70°C (3% ΔTR; CRV, 3%) • Rotational Life: 200 cycles (4% ΔTR; CRV, 3% or 3Q, whichever is greater) • Torque: 3.0 oz-in. maximum • Mechanical Stops: Wiper idles

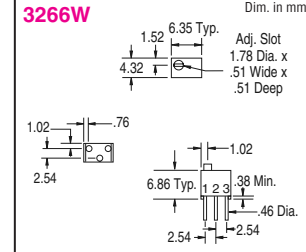

Res. (Ω)	Digi-Key Part No.	Digi-Key Part No.
10	3266W-100LF-ND	3266X-100LF-ND
20	3266W-200LF-ND	3266X-200LF-ND
50	3266W-500LF-ND	3266X-500LF-ND
100	3266W-101LF-ND	3266X-101LF-ND
200	3266W-201LF-ND	3266X-201-ND†
500	3266W-501LF-ND	3266X-501LF-ND
1K	3266W-102LF-ND	3266X-102LF-ND
2K	3266W-202LF-ND	3266X-202LF-ND
5K	3266W-502LF-ND	3266X-502LF-ND
10K	3266W-103LF-ND	3266X-103LF-ND
20K	3266W-203LF-ND	3266X-203LF-ND
25K	3266W-253LF-ND	3266X-253-ND†
50K	3266W-503LF-ND	3266X-503LF-ND
100K	3266W-104LF-ND	3266X-104LF-ND
200K	3266W-204LF-ND	3266X-204LF-ND
250K	3266W-254LF-ND	3266X-254-ND†
500K	3266W-504LF-ND	3266X-504-ND†
1M	3266W-105LF-ND	3266X-105-ND†

Series	1	Pricing 10	50
3266W/3266X	3.58	32.50	139.75

◆ RoHS Compliant † For RoHS Compliant Part Number change -ND to LF-ND

SERIES 3345 — 1/2" (12.70mm) Round/Single-Turn Wirewound/Industrial/Sealed

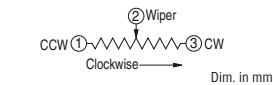

Features: • Industrial wirewound. • 1.0 watt power rating at 70°C **Characteristics:** • Resistance Tolerance: ±5% standard **Adjustment Angle:** 280° nominal **Power Rating:** 70°C - 1 watt; 150°C - 0 watt **Temperature Range:** -55°C - 150°C **Temperature Coefficient:** ±50ppm/°C **Load Life:** 1,000 hours 1 watt @ 70°C **Rotational Life:** 200 cycles (2% ΔTR; ENR, 500Q) **Mechanical Angle:** 310° nominal **Torque:** 5.0 oz-inch maximum **Stop Strength:** 15 oz-inch minimum

Res. (Ω)	Digi-Key Part No.	Nominal Resolution (Percent)
50	3345P-500-ND	0.58
100	3345P-101-ND	0.49
200	3345P-201-ND	0.49
500	3345P-501-ND	0.38
1K	3345P-102-ND	0.30
2K	3345P-202-ND	0.24
5K	3345P-502-ND	0.18
10K	3345P-103-ND	0.14
20K	3345P-203-ND	0.13

Series	1	Pricing 10	50
3345P	9.54	86.75	373.03

SERIES 3306 — 6mm Round/Single-Turn Cermet/Industrial/Open Frame

3306F

3306K

3306W

3306P

SERIES 3319 — 9mm Round/Single-Turn/Carbon/ Open Frame

Characteristics: • Resistance Tolerance: ±25% standard • Contact Resistance Variation: 3% maximum • Resolution: Infinite • Adjustment Angle: 235° nominal • Power Rating (200V maximum): 70°C = 0.2W • Temperature Range: -25°C - 100°C • Temperature Coefficient: ±1,000ppm/°C

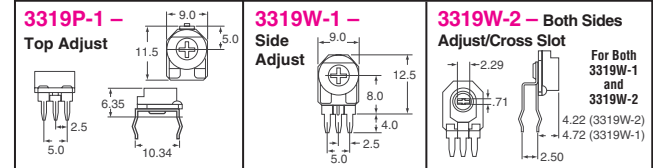

Series	Resistance (Ω)	Digi-Key Part No.	1	Pricing 10	50
3319P-1	100	3319P-101-ND	.41	2.93	12.83
	200	3319P-201-ND	.41	2.93	12.83
	1K	3319P-102-ND	.41	2.93	12.83
	5K	3319P-502-ND	.41	2.93	12.83
	10K	3319P-103-ND	.41	2.93	12.83
	100K	3319P-104-ND	.41	2.93	12.83
3319W-1	10K	3319W-1-103-ND	.36	2.60	11.40
	5K	3319W-502-ND	.36	2.60	11.40
3319W-2	10K	3319W-103-ND	.36	2.60	11.40
	100K	3319W-104-ND	.36	2.60	11.40

◆ RoHS Compliant

3306F

Characteristics: • Cross slot rotor design suitable for automatic adjustment equipment. • Board retention feature. • Dust resistant/splash resistant cover. • Front and top adjust styles. **Resistance Tolerance:** ±25% standard **Adjustment Angle:** 215° nominal **Power Rating** (100 volts maximum): 70°C - 0.2 watt **Temperature Range:** -25°C - 100°C **Temperature Coefficient:** ±250ppm/°C **Load Life:** 1,000 hours 0.2 watt @ 70°C (5% ΔTR) **Torque** (Operating): 4.5 oz-inch maximum **Stop Strength:** 6.5 oz-inch minimum

Res. (Ω)	Digi-Key Part No.	Digi-Key Part No.	Digi-Key Part No.	Digi-Key Part No.
100	3306F-101-ND	3306K-101-ND	3306P-101-ND	3306W-101-ND
200	3306F-201-ND	3306K-201-ND	3306P-201-ND	3306W-201-ND
500	3306F-501-ND	3306K-501-ND	3306P-501-ND	3306W-501-ND
1K	3306F-102-ND	3306K-102-ND	3306P-102-ND	3306W-102-ND
2K	3306F-202-ND	3306K-202-ND	3306P-202-ND	3306W-202-ND
5K	3306F-502-ND	3306K-502-ND	3306P-502-ND	3306W-502-ND
10K	3306F-103-ND	3306K-103-ND	3306P-103-ND	3306W-103-ND
20K	3306F-203-ND	3306K-203-ND	3306P-203-ND	3306W-203-ND
50K	3306F-503-ND	3306K-503-ND	3306P-503-ND	3306W-503-ND
100K	3306F-104-ND	3306K-104-ND	3306P-104-ND	3306W-104-ND
200K	3306F-204-ND	3306K-204-ND	3306P-204-ND	3306W-204-ND
500K	3306F-504-ND	3306K-504-ND	3306P-504-ND	3306W-504-ND
1M	3306F-105-ND	3306K-105-ND	3306P-105-ND	3306W-105-ND

Series	1	Pricing 10	100
3306F / 3306K / 3306P / 3306W	.71	5.30	49.50

◆ RoHS Compliant

More Product Available Online: www.digikey.com

Toll-Free: 1-800-344-4539 • Phone 218-681-6674 • Fax: 218-681-3380



Trimmer Potentiometers

SERIES 3292 — 3/8" (9.52mm) Square/Multiturn (25) Cermet/Industrial/Sealed

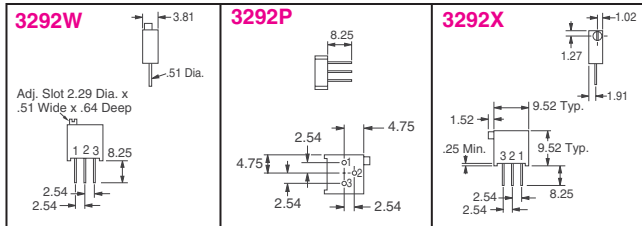

Wiper
 Clockwise →

Characteristics: • Resistance Tolerance: ±10% standard • Insulation Resistance: 500VDC 1,000MΩ minimum • Effective Travel: 25 turns nominal • Power Rating (400 volts maximum): 85°C — 0.5 watt; 150°C — 0 watt. • Temperature Range: -65°C - 150°C. • Temperature Coefficient: ±100 ppm/°C. • Load Life: 1,000 hours 0.5 watt @ 85°C (2% ΔTR; CRV, 3% or 3Ω, whichever is greater). • Rotational Life: 200 cycles (2% ΔTR; CRV, 3% or 3Ω, whichever is greater). • Torque: 5.0 oz-inch maximum • Mechanical Stops: Wiper idles.

Res. (Ω)	Digi-Key Part No.	Digi-Key Part No.	Digi-Key Part No.
100	—	3292W-101-ND†	3292X-101-ND
200	—	3292W-201-ND†	3292X-201LF-ND◆
500	—	3292W-501-ND†	3292X-501LF-ND◆
1K	3292P-102-ND	3292W-102LF-ND◆	3292X-102LF-ND◆
2K	—	3292W-202-ND†	3292X-202LF-ND◆
5K	—	3292W-502LF-ND◆	3292X-502LF-ND◆
10K	3292P-103-ND†	3292W-103LF-ND◆	3292X-103-ND†
20K	3292P-203-ND	3292W-203-ND†	3292X-203-ND†
50K	—	3292W-503LF-ND◆	3292X-503LF-ND◆
100K	—	3292W-104LF-ND◆	—
200K	3292P-204LF-ND◆	3292W-204LF-ND◆	—
500K	—	3292W-504LF-ND◆	—
1M	—	3292W-105-ND†	3292X-105-ND

Series	1	10	50
3292P/3292W/3292X	15.51	141.00	606.30

◆ RoHS Compliant † For RoHS Compliant Part Number change -ND to LF-ND.

SERIES 3299 — 3/8" (9.52mm) Square/Multiturn (25) Cermet/Industrial/Sealed

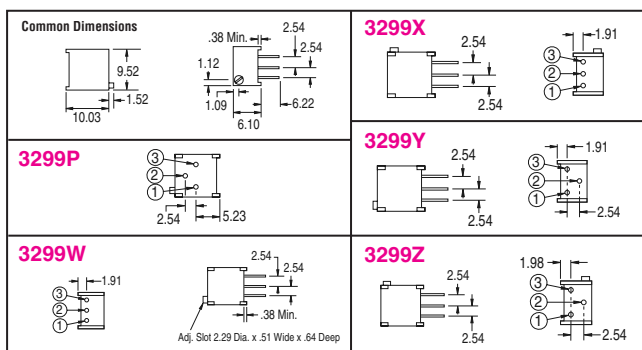

Characteristics: • Resistance Tolerance: ±10% standard • Insulation Resistance: 500vdc, 1,000MΩ minimum • Effective Travel: 25 turns nominal • Power Rating (300 volts maximum): 70°C — 0.5 watt; 125°C — 0 watt. • Temperature Range: -55°C - 125°C. • Temperature Coefficient: ±100ppm/°C. • Load Life: 1,000 hours 0.5 watt @ 70°C (3% ΔTR; CRV, 3% or 3Ω, whichever is greater). • Rotational Life: 200 cycles (4% ΔTR; CRV, 3% or 3Ω, whichever is greater). • Torque: 3.0 oz-inch maximum • Mechanical Stops: Wiper idles.

Res. (Ω)	Digi-Key Part No.	Digi-Key Part No.	Digi-Key Part No.	Digi-Key Part No.	Digi-Key Part No.
10	3299P-100LF-ND◆	3299W-100LF-ND◆	3299X-100LF-ND◆	3299Y-100LF-ND◆	3299Z-100-ND†
20	3299P-200-ND†	3299W-200LF-ND◆	3299X-200LF-ND◆	3299Y-200LF-ND◆	—
50	3299P-500-ND	3299W-500LF-ND◆	3299X-500-ND	3299Y-500-ND†	—
100	3299P-101LF-ND◆	3299W-101LF-ND◆	3299X-101LF-ND◆	3299Y-101LF-ND◆	3299Z-101-ND†
200	3299P-201-ND†	3299W-201LF-ND◆	3299X-201LF-ND◆	3299Y-201LF-ND◆	—
500	3299P-501LF-ND◆	3299W-501LF-ND◆	3299X-501LF-ND◆	3299Y-501LF-ND◆	3299Z-501LF-ND◆
1K	3299P-102LF-ND◆	3299W-102LF-ND◆	3299X-102LF-ND◆	3299Y-102LF-ND◆	3299Z-102LF-ND◆
2K	3299P-202LF-ND◆	3299W-202LF-ND◆	3299X-202-ND†	3299Y-202LF-ND◆	3299Z-202LF-ND◆
5K	3299P-502-ND†	3299W-502LF-ND◆	3299X-502LF-ND◆	3299Y-502LF-ND◆	3299Z-502LF-ND◆
10K	3299P-103LF-ND◆	3299W-103LF-ND◆	3299X-103LF-ND◆	3299Y-103LF-ND◆	3299Z-103LF-ND◆
20K	3299P-203LF-ND◆	3299W-203LF-ND◆	3299X-203LF-ND◆	3299Y-203LF-ND◆	3299Z-203LF-ND◆
25K	3299P-253-ND†	3299W-253LF-ND◆	—	3299Y-253LF-ND◆	—
50K	3299P-503-ND†	3299W-503LF-ND◆	3299X-503LF-ND◆	3299Y-503-ND†	3299Z-503-ND†
100K	3299P-104LF-ND◆	3299W-104LF-ND◆	3299X-104LF-ND◆	3299Y-104LF-ND◆	3299Z-104LF-ND◆
200K	3299P-204LF-ND◆	3299W-204LF-ND◆	3299X-204-ND†	3299Y-204LF-ND◆	3299Z-204LF-ND◆
250K	—	3299W-254LF-ND◆	3299X-254-ND†	3299Y-254LF-ND◆	—
500K	3299P-504-ND†	3299W-504LF-ND◆	3299X-504-ND†	3299Y-504LF-ND◆	—
1M	3299P-105LF-ND◆	3299W-105LF-ND◆	3299X-105LF-ND◆	3299Y-105LF-ND◆	3299Z-105LF-ND◆
2M	—	3299W-205LF-ND◆	—	3299Y-205LF-ND◆	—
5M	—	3299W-505LF-ND◆	3299X-505LF-ND◆	—	—

Series	1	10	50
3299P/3299Z	3.14	28.50	122.55
3299W/3299X/3299Y	2.92	26.50	113.95

◆ RoHS Compliant † For RoHS Compliant Part Number change -ND to LF-ND.

SERIES 3296 — 3/8" (9.52mm) Square/Multiturn (25) Cermet/Industrial/Sealed

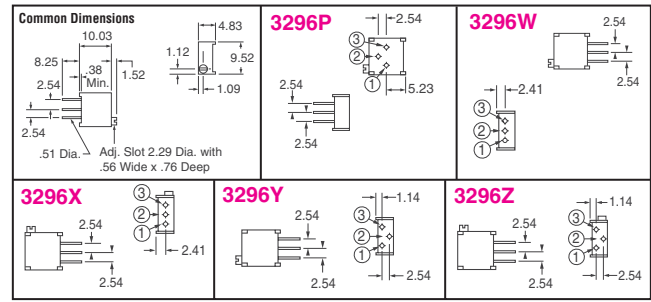

Characteristics: • Resistance Tolerance: ±10% standard • Insulation Resistance: 500VDC 1,000MΩ minimum • Effective Travel: 25 turns nominal • Power Rating (300 volts maximum): 70°C — 0.5 watt; 125°C — 0 watt. • Temperature Range: -55°C - 125°C. • Temperature Coefficient: ±100 ppm/°C. • Load Life: 1,000 hours 0.5 watt @ 70°C (3% ΔTR; CRV, 3% or 3Ω, whichever is greater). • Rotational Life: 200 cycles (4% ΔTR; CRV, 3% or 3Ω, whichever is greater). • Torque: 3.0 oz-inch maximum • Mechanical Stops: Wiper idles.

Res. (Ω)	Digi-Key Part No.	Digi-Key Part No.	Digi-Key Part No.	Digi-Key Part No.	Digi-Key Part No.
10	3296P-100LF-ND◆	3296W-100LF-ND◆	3296X-100LF-ND◆	3296Y-100LF-ND◆	—
20	3296P-200-ND†	3296W-200LF-ND◆	3296X-200LF-ND◆	3296Y-200LF-ND◆	3296Z-200-ND†
50	3296P-500LF-ND◆	3296W-500LF-ND◆	3296X-500LF-ND◆	3296Y-500LF-ND◆	3296Z-500-ND†
100	3296P-101-ND†	3296W-101LF-ND◆	3296X-101LF-ND◆	3296Y-101-ND†	3296Z-101LF-ND◆
200	3296P-201-ND†	3296W-201LF-ND◆	3296X-201LF-ND◆	3296Y-201LF-ND◆	3296Z-201LF-ND◆
500	3296P-501LF-ND◆	3296W-501LF-ND◆	3296X-501LF-ND◆	3296Y-501LF-ND◆	3296Z-501-ND†
1K	3296P-102LF-ND◆	3296W-102LF-ND◆	3296X-102LF-ND◆	3296Y-102LF-ND◆	3296Z-102LF-ND◆
2K	3296P-202LF-ND◆	3296W-202LF-ND◆	3296X-202LF-ND◆	3296Y-202LF-ND◆	3296Z-202LF-ND◆
5K	3296P-502LF-ND◆	3296W-502LF-ND◆	3296X-502LF-ND◆	3296Y-502LF-ND◆	3296Z-502LF-ND◆
10K	3296P-103LF-ND◆	3296W-103LF-ND◆	3296X-103LF-ND◆	3296Y-103LF-ND◆	3296Z-103-ND†
20K	3296P-203LF-ND◆	3296W-203LF-ND◆	3296X-203LF-ND◆	3296Y-203LF-ND◆	3296Z-203LF-ND◆
25K	—	3296W-253LF-ND◆	3296X-253LF-ND◆	3296Y-253LF-ND◆	3296Z-253-ND†
50K	3296P-503LF-ND◆	3296W-503LF-ND◆	3296X-503LF-ND◆	3296Y-503LF-ND◆	3296Z-503LF-ND◆
100K	3296P-104LF-ND◆	3296W-104LF-ND◆	3296X-104LF-ND◆	3296Y-104LF-ND◆	3296Z-104-ND†
200K	3296P-204LF-ND◆	3296W-204LF-ND◆	3296X-204LF-ND◆	3296Y-204LF-ND◆	3296Z-204-ND†
250K	—	3296W-254LF-ND◆	3296X-254LF-ND◆	3296Y-254-ND†	3296Z-254-ND†
500K	3296P-504LF-ND◆	3296W-504LF-ND◆	3296X-504LF-ND◆	3296Y-504-ND†	3296Z-504-ND†
1M	3296P-105-ND†	3296W-105-ND†	3296X-105LF-ND◆	3296Y-105-ND†	3296Z-105LF-ND◆
2M	—	3296W-205LF-ND◆	3296X-205LF-ND◆	3296Y-205LF-ND◆	3296Z-205-ND†
5M	—	3296W-505LF-ND◆	3296X-505LF-ND◆	—	3296Z-505-ND†

Series	1	10	50
3296P/3296Z	2.70	24.50	105.35
3296W/3296X/3296Y	2.50	22.75	97.83

◆ RoHS Compliant † For RoHS Compliant Part Number change -ND to LF-ND.

SERIES 3005 — 3/4" (19.05mm) Rectangular/Multiturn (20) Wirewound/Industrial/Sealed

Sealed to prevent contamination from fluxing, soldering and cleaning. **Characteristics:** • Resistance Tolerance: ±10% standard • Insulation Resistance: 500VDC 1,000MΩ minimum • Adjustment Travel: 20 turns nominal • Power Rating: 70°C — 1 watt; 125°C — 0 watt • Temperature Range: -65°C - 125°C • Temperature Coefficient: ±50ppm/°C • Load Life: 1,000 hours 1 watt @ 70°C (3% ΔTR) • Rotational Life: 200 cycles (4% ΔTR) • Torque: 5.0 oz-inch maximum • Mechanical Stops: Wiper idles

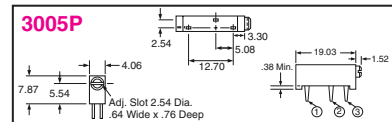

◆ RoHS Compliant

Res. (Ω)	Digi-Key Part No.	Nominal Resolution (Percent)
200	3005P-201-ND	0.7
500	3005P-501-ND	0.5
1K	3005P-102-ND◆	0.5
2K	3005P-202-ND	0.4
5K	3005P-502-ND◆	0.3
10K	3005P-103-ND◆	0.3
20K	3005P-203-ND◆	0.2

Series	1	10	50
3005P	11.22	102.00	438.60

◆ RoHS Compliant

SERIES TC73 — Surface Mount 3mm Single-Turn Top Adjust Carbon

Characteristics: • Resistance Tolerance: ±30% • Adjustment Angle: 260° • Power Rating: 05W • Temperature Range: -25°C - 85°C • Temperature Coefficient: ±250 ppm/°C • Rotational Life: 20 turns • Rotational Torque: 10-150g-cm maximum

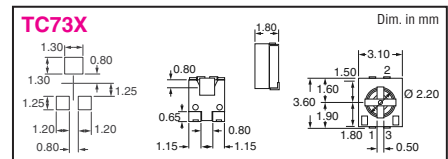

Series	Part No.	1	10	100	Part No.	1	10	100
TC73X	Add "CT-ND"	.20	1.65	14.40	Add "TR-ND"	2.00	10.00	100.00

◆ RoHS Compliant

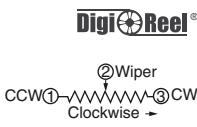

Res. (Ω)	Digi-Key Part No.
500	TC73X-501E□□-ND◆
1K	TC73X-102E□□-ND◆
2K	TC73X-202E□□-ND◆
5K	TC73X-502E□□-ND◆
10K	TC73X-103E□□-ND◆
20K	TC73X-203E□□-ND◆

Digi-Reel® Most SMT cutdown parts are available on a Digi-Reel®. For Digi-Reel part number, change 1-ND to 6-ND or CT-ND to DKR-ND. See Digi-Key® Services on page 2 for additional information.

More Product Available Online: www.digikey.com