

## D-Sub Adapters Connector Saver

A

Connector Size	Dimensions - Inch		
	A	B	C
9	1.215	0.492	0.236
15	1.546	0.492	0.236
25	2.091	0.492	0.236
37	2.755	0.492	0.236
15†	1.215	0.492	0.236
26†	1.546	0.492	0.236
44†	2.091	0.492	0.236
62†	2.755	0.492	0.236

No. of Pins	D-Sub	Digi-Key Part No.	1	Price Each	100
9	Male	GCLP09M09F-ND	3.60	2.48	2.03
15	Male	GCLP15M15F-ND	4.00	2.76	2.25
25	Female	GCLP25M25F-ND	4.42	3.09	2.53
37	Female	GCLP37M37F-ND	6.08	4.45	3.63
15	Male	GCHDL15M15F-ND†	5.29	3.83	3.14
26	Male	GCHDL26M26F-ND†	11.48	8.83	7.40
44	Female	GCHDL44M44F-ND†	12.65	9.73	8.15
62	Female	GCHDL62M62F-ND†	17.22	13.94	11.69

† High Density

## Gender Changer



Connector Size	Dimensions - Inch		
	A	B	C
9	1.215	0.492	0.236
15	1.546	0.492	0.236
25	2.091	0.492	0.236
37	2.755	0.492	0.236
15†	1.215	0.492	0.236
26†	1.546	0.492	0.236
44†	2.091	0.492	0.236
62†	2.755	0.492	0.236

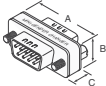
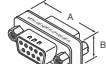

No. of Pins	D-Sub	Digi-Key Part No.	1	Price Each	100
9	Female to Female	GCLP09F09F-ND	3.48	2.40	1.96
15	Female to Female	GCLP15F15F-ND	4.12	2.77	2.32
25	Female to Female	GCLP25F25F-ND	4.54	3.16	2.60
37	Female to Female	GCLP37F37F-ND	6.19	4.53	3.69
9	Male to Male	GCLP09M09M-ND	3.42	2.28	1.86
15	Male to Male	GCLP15M15M-ND	3.89	2.68	2.19
25	Male to Male	GCLP25M25M-ND	4.26	2.97	2.44
37	Male to Male	GCLP37M37M-ND	5.93	4.34	3.54
15	Female to Male	GCHDL15F15M-ND†	5.20	3.80	3.10
26	Female to Male	GCHDL26F26M-ND†	11.57	8.90	7.46
44	Female to Male	GCHDL44F44M-ND†	12.87	9.90	8.30
62	Female to Male	GCHDL62F62M-ND†	17.39	14.08	11.80
15	Male to Female	GCHDL15M15F-ND†	5.13	3.71	3.04
26	Male to Female	GCHDL26M26F-ND†	11.34	8.72	7.31
44	Male to Female	GCHDL44M44F-ND†	12.42	9.55	8.01
62	Male to Female	GCHDL62M62M-ND†	17.01	13.77	11.55

† High Density

## RJADK Series RJ45 Adaptor



- 9, 15, and 25 position D-Subs/ both male and female versions • Supplied with contacts pre-crimped onto conductors - No crimp tool required
- Snap together design allows low cost assembly
- 4 - 40 thumbscrews supplied pre-installed in backshell



Connector Size	Dimensions - Inch				
	A	B	C	D	E
9	1.299	0.984	1.949	0.632	0.787
15	1.631	1.311	1.543	0.632	0.894
25	2.161	1.874	1.545	0.632	1.339

No. of Pins	D-Sub	Type	Digi-Key Part No.	1	Price Each	100
9	Female	Black Plastic	RJADK09P7080811-ND	4.12	2.84	2.32
15	Female	Black Plastic	RJADK09S7080811-ND	4.12	2.84	2.32
15	Female	Black Plastic	RJADK15P7080811-ND	4.12	2.84	2.32
15	Female	Black Plastic	RJADK15S7080811-ND	4.12	2.84	2.32
25	Female	Black Plastic	RJADK25P7080811-ND	4.12	2.84	2.32
25	Female	Black Plastic	RJADK25S7080811-ND	4.12	2.84	2.32
9	Male	Metalized Plastic	RJADK09P7080821-ND	5.13	3.71	3.04
9	Female	Metalized Plastic	RJADK09S7080821-ND	5.13	3.71	3.04
15	Male	Metalized Plastic	RJADK15P7080821-ND	5.13	3.71	3.04
15	Female	Metalized Plastic	RJADK15S7080821-ND	5.13	3.71	3.04
25	Male	Metalized Plastic	RJADK25P7080821-ND	5.13	3.71	3.04
25	Female	Metalized Plastic	RJADK25S7080821-ND	5.13	3.71	3.04
9	Male	Gray Plastic	RJADK09P7080831-ND	4.12	2.84	2.32
9	Female	Gray Plastic	RJADK09S7080831-ND	4.12	2.84	2.32
15	Male	Gray Plastic	RJADK15P7080831-ND	4.12	2.84	2.32
15	Female	Gray Plastic	RJADK15S7080831-ND	4.12	2.84	2.32
25	Male	Gray Plastic	RJADK25P7080831-ND	4.12	2.84	2.32
25	Female	Gray Plastic	RJADK25S7080831-ND	4.12	2.84	2.32

## Backshells

### 952 Series - Straight/Top Entry



- 4 - 40 thumbscrews supplied with backshell
- More robust design for those areas that need it
- 360° shielding with mechanical strain relief
- 2 piece metalized plastic compression insert supplied



Connector Size	Dimensions - Inch			
	A	B	C	D
9	1.626	0.606	0.984	1.268
15	1.705	0.606	1.312	1.598
25	1.949	0.606	1.852	2.146
37	2.138	0.606	2.500	2.783

No. of Pins	Type	Digi-Key Part No.	1	Price Each	100	NorComp Part No.
9	Die Cast	952-09SCE-ND	8.23	6.18	5.15	952-009-030R121
15	Nickel	952-15SCE-ND	6.95	5.15	4.26	952-015-030R121
25	Nickel	952-25SCE-ND	7.05	5.22	4.32	952-025-030R121
37	Nickel	952-37SCE-ND	9.82	7.48	6.41	952-037-030R121

### 956 Series Straight/Top Entry



- Snap together design allows low cost assembly
- 4 - 40 mating screw supplied with backshell
- Quick assembly strain relief allows positive retention

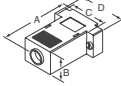

Connector Size	Dimensions - Inch			
	A	B	C	D
9	1.618	0.622	0.984	1.201
15	1.634	0.610	1.311	1.579
25	1.732	0.670	1.874	2.110

No. of Pins	Type	Digi-Key Part No.	1	Price Each	100	NorComp Part No.
9	Gray Plastic	956-09SPGE-ND	.95	.58	.42	956-009-010R031
15	Gray Plastic	956-15SPGE-ND	.95	.58	.42	956-015-010R031
25	Gray Plastic	956-25SPGE-ND	1.01	.63	.46	956-025-010R031
9	Black Plastic	956-09SPBE-ND	.95	.58	.42	956-009-010R011
15	Black Plastic	956-15SPBE-ND	.95	.58	.42	956-015-010R011
25	Black Plastic	956-25SPBE-ND	1.01	.63	.46	956-025-010R011
9	Metal Plastic	956-09SMPE-ND	1.43	.92	.69	956-009-020R121
15	Metal Plastic	956-15SMPE-ND	1.48	.96	.70	956-015-020R121
25	Metal Plastic	956-25SMPE-ND	1.63	1.02	.77	956-025-020R121

### 970 Series - Straight/Top Entry

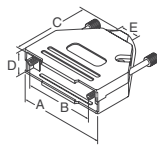

- Die Cast: Lightweight zinc. Plating: Nickel over copper or black die cast
- Metalized Plastic: High temperature plastic UL 94V-0. Plating: Nickel over copper
- Plastic-RoHS Compliant: High temperature plastic UL 94V-0, black
- Hardware: Steel with nickel or black chromate

Connector Size	Dimensions - Inch				
	A	B	C	D	E
9	1.228	.984	1.571	.610	.465
15	1.555	1.312	1.634	.610	.465
25	2.102	1.852	1.913	.610	.465
37	2.744	2.500	2.110	.610	.465

No. of Pins	Type	Digi-Key Part No.	1	Price Each	100	NorComp Part No.
37	Black Die Cast	970-37BC-ND	11.22	9.68	6.58	970-037-040-011

RoHS Compliant						
No. of Pins	Type	Digi-Key Part No.	1	Price Each	100	NorComp Part No.
9	Die Cast	970-09NE-ND	5.53	4.77	3.25	970-009-030R121
15	Nickel	970-15NE-ND	6.58	5.67	3.86	970-015-030R121
25	Nickel	970-25NE-ND	6.58	5.67	3.86	970-025-030R121
37	Nickel	970-37NE-ND	10.11	8.72	5.93	970-037-030R121
9	Metalized Plastic	970-09MPE-ND	5.16	4.46	3.03	970-009-020R121
15	Metalized Plastic	970-15MPE-ND	5.38	4.64	3.16	970-015-020R121
25	Metalized Plastic	970-25MPE-ND	5.59	4.83	3.28	970-025-020R121
37	Metalized Plastic	970-37MPE-ND	6.21	5.36	3.64	970-037-020R121
9	Black Plastic	970-09BPE-ND	2.52	2.18	1.48	970-009-010R011
15	Black Plastic	970-15BPE-ND	2.52	2.18	1.48	970-015-010R011
25	Black Plastic	970-25BPE-ND	2.64	2.28	1.56	970-025-010R011
37	Black Plastic	970-37BPE-ND	2.73	2.36	1.61	970-037-010R011
9	Black Die Cast	970-09BCA-ND	5.16	3.73	3.06	970-009-040R011
15	Black Die Cast	970-15BCA-ND	5.67	4.31	3.52	970-015-040R011
25	Black Die Cast	970-25BCA-ND	5.90	4.31	3.52	970-025-040R011
37	Black Die Cast	970-37BCA-ND	7.90	5.93	4.94	970-037-040R011

## 972 Series - Slim-Line Clam Shell Style



- High temperature ABS plastic UL94V-2

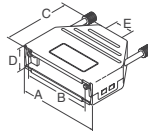

Conn. Size	Dimensions - Inch				
	A	B	C	D	E
9	1.240	.984	1.339	.591	.453
15	1.575	1.312	1.339	.591	.453
25	2.106	1.852	1.575	.591	.453
37	2.795	2.500	1.575	.591	.453

No. of Pins	Type	Digi-Key Part No.	1	Price Each	100	NorComp Part No.
9	Gray Plastic	972-09SGE-ND	2.80	2.42	1.65	972-009-01SR031
15	Gray Plastic	972-15SGE-ND	2.95	2.55	1.74	972-015-01SR031
25	Gray Plastic	972-25SGE-ND	3.11	2.68	1.83	972-025-01SR031
37	Gray Plastic	972-37SGE-ND	3.26	2.81	1.92	972-037-01SR031
9	Black Plastic	972-09SBE-ND	2.80	2.42	1.65	972-009-01SR011
15	Black Plastic	972-15SBE-ND	2.95	2.55	1.74	972-015-01SR011
25	Black Plastic	972-25SBE-ND	3.11	2.68	1.83	972-025-01SR011
37	Black Plastic	972-37SBE-ND	3.26	2.81	1.92	972-037-01SR011
9	Red Plastic	972-09SR-ND	2.64	2.28	1.55	972-009-01SR061
15	Red Plastic	972-15SR-ND	2.76	2.38	1.62	972-015-01SR061
25	Red Plastic	972-25SR-ND	2.90	2.50	1.70	972-025-01SR061
37	Red Plastic	972-37SR-ND	3.10	2.68	1.82	972-037-01SR061
9	Yellow Plastic	972-09SY-ND	2.64	2.28	1.55	972-009-01SR081
15	Yellow Plastic	972-15SY-ND	2.76	2.38	1.62	972-015-01SR081
25	Yellow Plastic	972-25SY-ND	2.90	2.50	1.70	972-025-01SR081
37	Yellow Plastic	972-37SY-ND	3.10	2.68	1.82	972-037-01SR081

### 973 Series - Straight/Top Entry

- Metalized Plastic: High temperature plastic UL 94V-0. Plating: Nickel over copper
- Plastic: High temperature plastic UL 94V-2
- Plastic-RoHS Compliant: High temperature plastic UL 94V-0, black
- Hardware: Steel, nickel plated

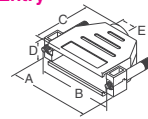

Connector Size	Dimensions - Inch				
	A	B	C	D	E
9	1.240	.984	1.221	.598	.335
15	1.575	1.312	1.378	.598	.335
25	2.106	1.852	1.496	.598	.433
37	2.756	2.500	1.575	.598	.433

No. of Pins	Type	Digi-Key Part No.	1	Price Each	100	NorComp Part No.
37	Metalized Plastic	973-37MP-ND	10.41	8.98	6.11	973-037-020-121
37	Plastic	973-37BP-ND	5.13	4.43	3.01	973-037-010-011

**978 Series – Plastic or Metalized**

- Available in both plain plastic and metalized for EMI/RFI suppression • Over 60 dB shielding • EMI/RFI Plating – Electroplated with nickel over copper
- **Materials:** • Shell: Thermoplastic polyester, UL rated 94V-0
- **Screw locks:** Brass • **RoHS Compliant Materials:** • Metalized Plastic: High Temperature, UL 94H-B Plating: Chrome (gray) • Steel, nickel plated

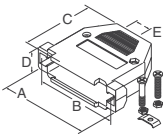

Connector Size	Dimensions – Inch				
	A	B	C	D	E
9	1.220	.984	1.693	.655	.276
15	1.535	1.312	1.693	.655	.315
25	2.118	1.852	1.929	.655	.374
37	2.756	2.500	1.929	.655	.433
50	2.650	2.406	1.909	.655	.551

No. of Pins	Type	Digi-Key Part No.	Price Each			NorComp Part No.
			1	10	100	
9	Gray Plastic	909CE-ND	1.34	1.16	.79	978-009-010R031
15		915CE-ND	1.42	1.22	.83	978-015-010R031
25		925CE-ND	1.48	1.28	.87	978-025-010R031
37		937CE-ND	2.10	1.82	1.24	978-037-010R031
50		950CE-ND	2.14	1.85	1.26	978-050-010R031
9	Metalized Plastic	909CAE-ND	1.65	1.42	.97	978-009-020R121
15		915CAE-ND	1.89	1.63	1.11	978-015-020R121
25		925CAE-ND	2.00	1.73	1.18	978-025-020R121

**979 Series – Plastic or Metalized Backshell**

- ABS high temperature plastic UL94H-B
- Chrome plating

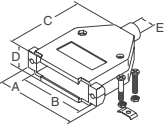

Conn. Size	Dimensions – Inch				
	A	B	C	D	E
9	1.232	.984	1.913	.656	.354
15	1.555	1.312	1.895	.669	.374
25	2.100	1.852	1.900	.655	.397
37	2.748	2.500	1.900	.655	.512
50	2.697	2.406	1.900	.770	.512

No. of Pins	Type	Digi-Key Part No.	Price Each			NorComp Part No.
			1	10	100	
9	Gray Plastic	979-09PGE-ND	1.38	1.19	.81	979-009-010R031
15		979-15PGE-ND	1.31	1.13	.77	979-015-010R031
25		979-25PGE-ND	1.42	1.22	.83	979-025-010R031
37		979-37PGE-ND	2.62	2.26	1.54	979-037-010R031
50		979-50PGE-ND	2.80	2.41	1.64	979-050-010R031
9	Metalized Plastic	979-09MPE-ND	1.73	1.50	1.02	979-009-020R121
15		979-15MPE-ND	1.88	1.62	1.10	979-015-020R121
25		979-25MPE-ND	2.12	1.83	1.25	979-025-020R121
37		979-37MPE-ND	3.60	3.11	2.12	979-037-020R121
50		979-50MPE-ND	3.89	3.36	2.28	979-050-020R121

**979 Series – Die-Cast Zinc**

- Rubber grommet/ strain relief for complete EMI/RFI shielding (over 70db)
- Solid die-cast ZINC construction
- Supplied complete with rubber grommet kit and male screw locks.

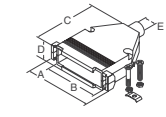

Connector Size	Dimensions – Inch				
	A	B	C	D	E
9	1.22	.79	.63	1.9	.42
15	1.55	1.11	.63	1.9	.42
25	2.10	1.64	.63	1.9	.42
37	2.73	2.27	.63	1.9	.43
50	2.64	2.18	.77	1.9	.73

No. of Pins	Type	Digi-Key Part No.	Price Each			NorComp Part No.
			1	10	100	
9	Die Cast Zinc	909ZE-ND	2.59	2.23	1.52	979-009-030R121
15		915ZE-ND	2.94	2.54	1.73	979-015-030R121
25		925ZE-ND	3.61	3.12	2.12	979-025-030R121
37		937ZE-ND	5.39	4.65	3.16	979-037-030R121
50		950ZE-ND	7.65	6.00	4.49	979-050-030R121

**994 Series – Die Cast, Ethernet**

**Material:** Die cast zinc alloy, nickel plated. Included are housing screw and housing nuts.

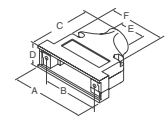

Conn. Size	Dimensions – Inch					
	A	B	C	D	E	F
9	1.244	.984	1.82	.614	.433	.790
15	1.575	1.312	1.82	.665	.433	1.135
25	2.106	1.852	1.82	.630	.433	1.640

No. of Pins	Type	Digi-Key Part No.	Price Each			NorComp Part No.
			1	10	100	
9	Straight	994-09DCE-ND	5.41	3.39	3.23	994-009-030R121
15		994-15DCE-ND	5.62	3.53	3.35	994-015-030R121
25		994-25DCE-ND	6.29	3.95	3.76	994-025-030R121

**981 Series – Ethernet**

- **Materials:**
- Zinc alloy ingot Plating: Nickel over copper
- Hardware: Steel, nickel plated

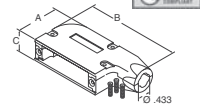

Connector Size	Dimensions – Inch					
	030			130		
	A	B	C	A	B	C
9	.984	1.240	1.850	1.265	1.850	0.628
15	1.312	1.555	2.323	1.580	2.314	0.639
25	1.852	2.106	2.835	2.143	2.870	0.633

No. of Pins	Type	Digi-Key Part No.	Price Each			NorComp Part No.
			1	10	100	
9	Die Cast	909ERE-ND	5.24	3.79	3.11	981-009-030R121
15		915ERE-ND	5.36	3.92	3.20	981-015-030R121
25		925ERE-ND	6.16	4.51	3.68	981-025-030R121
9	Rt. Angle	981-09RC-ND†	4.65	3.24	2.66	981-009-130R121
15		981-15RC-ND†	4.82	3.36	2.76	981-015-130R121
25		981-25RC-ND†	5.20	3.80	3.10	981-025-130R121

† With Thumbscrews

**950 Series – 60° Entry**

- **FEATURES:** • 4 – 40 mating screws supplied with backshell • Snap together design reduces assembly cost • Mechanical strain relief provides secure cable retention • Hood is the same thickness as connector • 60° exit promotes stacking and is suitable in extremely narrow spaces

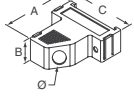

Conn. Size	Dimensions – Inch				
	A	B	C	ø - Plastic	ø - Metal
9	1.457	0.496	1.409	0.315	0.354
15	1.496	0.496	1.736	0.315	0.354
25	1.614	0.496	2.280	0.354	0.354
37	1.614	0.496	2.925	0.354	0.354

No. of Pins	Type	Digi-Key Part No.	Price Each			NorComp Part No.
			1	10	100	
9	Plastic	950-09P60E-ND	6.32	4.62	3.77	950-009-010R011
15		950-15P60E-ND	6.50	4.81	3.98	950-015-010R011
25		950-25P60E-ND	6.75	5.00	4.14	950-025-010R011
37		950-37P60E-ND	7.35	5.44	4.50	950-037-010R011
9		950-09MP60E-ND	11.36	8.65	7.41	950-009-020R121
15	Metal	950-15MP60E-ND	11.93	9.17	7.69	950-015-020R121
25		950-25MP60E-ND	12.33	9.48	7.95	950-025-020R121
37		950-37MP60E-ND	13.60	10.70	8.97	950-037-020R121

**951 Series – 60° Entry**

- 4 – 40 thumbscrews supplied with backshell
- Snap together design reduces assembly cost
- Mechanical strain relief provides secure cable retention
- Hood is the same thickness as connector
- 60° exit promotes stacking and is suitable in extremely narrow spaces

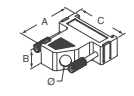

Connector Size	Dimensions – Inch				
	A	B	C	ø - Plastic	ø - Metal
9	1.457	0.496	1.409	0.315	0.354
15	1.496	0.496	1.736	0.315	0.354
25	1.614	0.496	2.280	0.354	0.354
37	1.614	0.496	2.925	0.354	0.354

No. of Pins	Type	Digi-Key Part No.	Price Each			NorComp Part No.
			1	10	100	
9	Plastic	951-0960PE-ND	6.32	4.62	3.77	951-009-010R011
15		951-15P60E-ND	7.45	5.52	4.56	951-015-010R011
25		951-25P60E-ND	7.65	5.51	4.59	951-025-010R011
37		951-37P60E-ND	8.11	6.09	5.07	951-037-010R011
9		951-09MP60E-ND	11.36	8.65	7.41	951-009-020R121
15	Metal	951-15MP60E-ND	12.78	9.83	8.24	951-015-020R121
25		951-25MP60E-ND	13.14	10.11	8.47	951-025-020R121
37		951-37MP60E-ND	14.67	11.54	9.68	951-037-020R121

**954 Series – 45° Exit Ethernet Backshell**

- Die Cast for excellent shielding
- Easy assembly reduces manufacturing cost
- 2 Piece grommet with various I.D.s included to enhance shielding and provide positive retention
- Slide locks and posts must be purchased separately

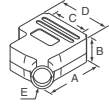

Connector Size	Dimensions – Inch				
	A	B	C	D	E
9	1.429	0.571	0.984	1.220	0.512
15	1.587	0.571	1.312	1.555	0.512
25	1.587	0.571	1.852	2.094	0.512
37	1.587	0.571	2.500	2.744	0.512

No. of Pins	Type	Digi-Key Part No.	Price Each			NorComp Part No.
			1	10	100	
9	Die Cast	954-09C45E-ND	6.32	4.62	3.77	954-009-030R121
15		954-15C45E-ND	7.35	5.44	4.50	954-015-030R121
25		954-25C45E-ND	7.53	5.44	4.52	954-025-030R121
37		954-37C45E-ND	10.72	8.16	6.99	954-037-030R121

**971 Series – 45° Entry**

- **Die Cast:** Lightweight zinc. Plating: Nickel over copper or black die cast
- **Metalized Plastic:** High temperature plastic UL 94V-0. Plating: Nickel over copper
- **Plastic:** High temperature plastic UL 94V-2
- **Plastic-RoHS Compliant:** High temperature plastic UL 94V-0, black
- **Hardware:** Steel with nickel or black plating

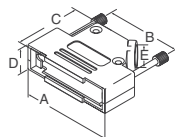

Connector Size	Dimensions – Inch				
	A	B	C	D	E
9	1.220	.984	1.496	.610	.465
15	1.595	1.312	1.618	.610	.465
25	2.114	1.852	1.646	.610	.465
37	2.748	2.500	1.646	.610	.465

No. of Pins	Type	Digi-Key Part No.	Price Each			NorComp Part No.
			1	10	100	
37	Nickel	971-37N45-ND	10.56	9.10	6.19	971-037-030-121
37	Plastic	971-37MP45-ND	6.53	5.63	3.83	971-037-020-121

**RoHS Compliant**

9	Nickel	971-09N45E-ND	5.53	4.77	3.25	971-009-030R121
15		971-15N45E-ND	6.58	5.67	3.86	971-015-030R121
25		971-25N45E-ND	6.58	5.67	3.86	971-025-030R121
37	Plastic	971-37N45E-ND	10.05	8.67	5.90	971-037-030R121
9		971-09MP45E-ND	5.16	4.46	3.03	971-009-020R121
15		971-15MP45E-ND	5.38	4.64	3.16	971-015-020R121
25	Plastic	971-25MP45E-ND	5.59	4.83	3.	

**953 Series – 35° Entry**

- 4 - 40 thumbscrews supplied with backshell (9 position only comes with 1 thumbscrew)
- More robust design for those areas that need it
- Fully tapped assembly holes allow easy assembly keeping manufacturing cost down
- 360° shielding with mechanical strain relief
- 2 Piece metalized plastic compression insert supplied

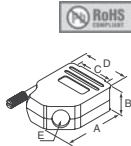

Connector Size	Dimensions – Inch				
	A	B	C	D	E
9	1.693	0.610	0.984	1.260	0.512
15	1.693	0.610	1.312	1.591	0.512
25	1.890	0.610	1.852	2.126	0.512
37	2.087	0.610	2.500	2.776	0.512

No. of Pins	Type	Digi-Key Part No.	Price Each			NorComp Part No.
			1	10	100	
9		953-09C35E-ND	6.38	4.72	3.91	953-009-030R121
15	Die	953-15C35E-ND	7.25	5.37	4.44	953-015-030R121
25	Cast	953-25C35E-ND	7.45	5.52	4.56	953-025-030R121
37		953-37C35E-ND	10.19	7.76	6.65	953-037-030R121

**982 Series – Plastic or Metalized**

- Cable Exit Top or Side
- Available in both plain plastic and metalized for EMI/RFI suppression
- Over 60dB shielding
- Operating Temperature: -35°C ~ 95°C

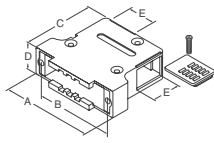

**Materials:** • Shell: Thermoplastic polyester; UL rated 94V-0 • Screw locks: Brass • EMI/RFI Plating: Electroplated with nickel over copper. Electroplated parts not UL rated

**RoHS Compliant Materials:** • Metalized Plastic: High temperature UL 94V-0 Plating: Electroplated nickel over copper • Plastic: High temperature plastic UL 94V-0 (gray) • Hardware: Steel, nickel plated

Connector Size	Dimensions – Inch				
	A	B	C	D	E
9†	1.23	.984	1.38	.630	.350
15	1.56	1.312	1.61	.630	.374
25	2.10	1.852	1.81	.630	.444
37	2.74	2.5	1.81	.630	.444
50	2.65	2.406	1.81	.735	.543

No. of Pins	Type	Digi-Key Part No.	Price Each			NorComp Part No.
			1	10	100	
50	Gray Plastic	950U-ND	5.12	4.42	3.01	982-050-010-031

**RoHS Compliant**

9	Gray Plastic	909UE-ND†	4.35	3.00	2.45	982-009-010R031
15		915UE-ND	4.82	3.36	2.76	982-015-010R031
25		925UE-ND	5.12	3.57	2.93	982-025-010R031
37		937UE-ND	5.32	3.94	3.16	982-037-010R031
50		950UE-ND	5.56	4.07	3.32	982-050-010R031
9	Shielded Plastic	909UAE-ND†	6.88	5.09	4.21	982-009-020R121
15		915UAE-ND	7.90	5.93	4.94	982-015-020R121
25		925UAE-ND	8.40	6.30	5.25	982-025-020R121
37		937UAE-ND	9.86	7.20	6.17	982-037-020R121
50		950UAE-ND	10.37	7.90	6.77	982-050-020R121

† 9-pin does not have a 90° cable entry.

**975 Series – Plastic or Metalized**

- 3-Way entry allows choice of entry options or use of multiple cable entries
- 4 - 40 thumbscrews supplied with backshell
- Fully tapped assembly holes allow easy assembly, keeping manufacturing cost down
- Metalized plastic provides up to 60dB shielding

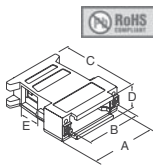

Connector Size	Dimensions – Inch				
	A	B	C	D	E
9†	1.213	.984	1.800	.600	.300
15	1.541	1.312	1.800	.600	.335
25	2.088	1.852	1.800	.600	.375
37	2.735	2.500	1.800	.600	.400

No. of Pins	Type	Digi-Key Part No.	Price Each			NorComp Part No.
			1	10	100	
9	Metalized Plastic	975-09MPA-ND†	6.92	5.97	4.06	975-009-020R121
15		975-15MPA-ND	7.16	6.18	4.20	975-015-020R121
25		975-25MPA-ND	7.35	6.34	4.31	975-025-020R121
37		975-37MPA-ND	9.93	8.56	5.83	975-037-020R121
9	Black Plastic	975-09BPA-ND†	5.81	5.01	3.41	975-009-010R011
15		975-15BPA-ND	5.81	5.01	3.41	975-015-010R011
25		975-25BPA-ND	5.81	5.01	3.41	975-025-010R011
37		975-37BPA-ND	7.90	6.81	4.64	975-037-010R011

† 9 position has top cable entry only

**976 Series – Plastic, Flat Ribbon**

ABS high temperature plastic 94HB. Complete with 4-40 mating screws, housing screws and housing nuts.

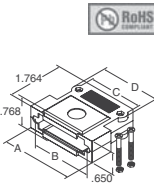

Conn. Size	Dimensions – Inch			
	A	B	C	D
9	1.319	.984	.758	.946
15	1.622	1.312	1.102	1.289
25	2.157	1.852	1.642	1.874
37	2.815	2.500	2.283	2.470

No. of Pins	Type	Digi-Key Part No.	Price Each			NorComp Part No.
			1	10	100	
9	Gray Plastic	976-09RPE-ND	1.55	1.34	.92	976-009-010R031
15		976-15RPE-ND	1.77	1.53	1.04	976-015-010R031
25		976-25RPE-ND	2.05	1.77	1.21	976-025-010R031
37	976-37RPE-ND	2.19	1.89	1.29	976-037-010R031	

**957 Series – Gender Changer Backshell**

- Snap together design allows low cost assembly
- 4 - 40 Mating screw for male connectors supplied with backshell
- 4 - 40 female coupling for females connectors sold separately
- Internal cavity designed for PCB

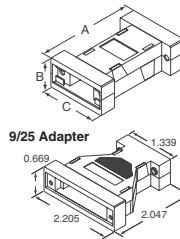

Connector Size	Dimensions – Inch		
	A	B	C
9	2.083	0.653	0.984
15	2.047	0.630	1.311
25	2.087	0.638	1.852

No. of Pins	Type	Digi-Key Part No.	Price Each			NorComp Part No.
			1	10	100	
9	Black Plastic	957-0911E-ND	1.43	.92	.69	957-009-010R011
15		957-1511E-ND	1.55	.97	.74	957-015-010R011
9/25		957-92511E-ND	1.55	.97	.74	957-925-010R011
25		957-2511E-ND	1.55	.97	.74	957-025-010R011
9		957-0931E-ND	1.43	.92	.69	957-009-010R031
15	Gray Plastic	957-1531E-ND	1.55	.97	.74	957-015-010R031
9/25		957-92531E-ND	1.55	.97	.74	957-925-010R031
25		957-2531E-ND	1.55	.97	.74	957-025-010R031
9		957-0921E-ND	2.18	1.46	1.15	957-009-020R121
15		957-1521E-ND	2.34	1.59	1.23	957-015-020R121
9/25	Metalized Plastic	957-92521E-ND	2.34	1.59	1.23	957-925-020R121
25		957-2521E-ND	2.34	1.59	1.23	957-025-020R121

**983 Series – Plain Plastic or Metalized Plastic**

- May be used as a "Gender Changer," pin-out changer, or standard backshell
- Snap-together assembly
- Half-clamp with self-tapping screws provides positive strain-relief
- Available in plain plastic or metalized for EMI/RFI shielding

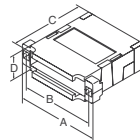

Connector Size	Dimensions – Inch				Max. Cable Dia.
	A	B	C	D	
9	1.25	.98	1.92	.65	.27
15	1.56	1.31	1.92	.63	.47
25	2.12	1.85	1.92	.63	.47
37	2.75	2.50	1.92	.63	.47
50	2.75	2.40	1.92	.75	.47

No. of Pins	Type	Digi-Key Part No.	Price Each			NorComp Part No.
			1	10	100	
37	Plain Plastic	937P-ND	2.78	2.40	1.64	983-037-010-031
25	Metalized Plastic	925M2-ND	2.37	2.05	1.39	983-025-020-121
50		950M2-ND	3.77	3.25	2.21	983-050-020-121

**RoHS Compliant**

9	Plain Plastic	909PE-ND	1.34	1.16	.79	983-009-010R031
15		915PE-ND	1.60	1.39	.95	983-015-010R031
25		925PE-ND	1.92	1.66	1.13	983-025-010R031
37		937PE-ND	3.26	2.82	1.92	983-037-010R031
50		950PE-ND	3.44	2.97	2.02	983-050-010R031
9	Metalized Plastic	909M2E-ND	2.11	1.82	1.24	983-009-020R121
15		915M2E-ND	2.26	1.95	1.33	983-015-020R121
25		925M2E-ND	2.89	2.49	1.70	983-025-020R121
37		937M2E-ND	3.75	3.23	2.20	983-037-020R121
50		950M2E-ND	4.60	3.97	2.70	983-050-020R121

**D-Sub Backshell Design Kit**

Each kit contains a backshell from several different Norcomp backshell series, and a quick reference guide. The data sheet for each kit has a detailed list of what backshells are included.

Type	Digi-Key Part No.	Price Each
Plastic	DESIGNKIT-010-ND	47.25
Metalized Plastic	DESIGNKIT-020-ND	47.25
Die Cast	DESIGNKIT-030-ND	47.25

**Non-Conductive Rubber Grommet Sets**

For better EMI/RFI Shielding and/or strain relief. For use with D-Sub Backshells. Note: Grom-9/25 and Grom-50 have four grommets per set and Grom-37 has three per set.



Description	Outside Dia. A (Inch)		Inside Dia. B (Inch)	
	1	100	1	100
9/25	.400	.185	.248	.290
37	.620	.320	.410	.500
50	.730	.340	.425	.495

Description	Digi-Key Part No.	Price Each			NorComp Part No.
		1	10	100	
DB 37 Grom. Set	902G-ND	1.06	.92	.63	162-000-037-000
DB 50 Grom. Set	903G-ND	1.45	1.25	.85	162-000-050-000

**RoHS Compliant**

DB 9/25 Grom. Set	901GA-ND	.46	.40	.28	162-000-925R000
DB 37 Grom. Set	902GA-ND	1.17	1.01	.69	162-000-037R000
DB 50 Grom. Set	903GA-ND	1.54	1.33	.91	162-000-050R000

**112 Series – Solder Cup Connector with Right Angle Backshell (Centronics Type)**

**Material:**

- Insulator: Glass-filled thermoplastic, UL Rated 94V-0.
- Contacts: Copper alloy.
- Shell: Steel, nickel plated.
- Contact Plating: Gold plated.

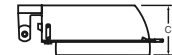

Connector Size	Dimensions – Inch			
	A	B	C	D
50	3.780	2.538	1.325	.646

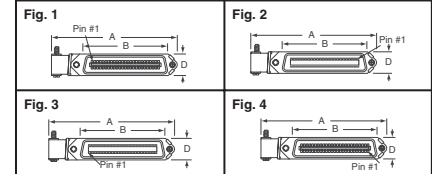

Fig.	No. of Pins	Type	Digi-Key Part No.	Price Each			NorComp Part No.
				1	10	100	
1	50	Male	1550RM-ND	9.19	7.93	5.39	112-050-103-011
2	50	Female	1550RF-ND	9.19	7.93	5.39	112-050-203-011
3	50	Female	1550LF-ND	9.19	7.93	5.39	112-050-203-021

**RoHS Compliant**

1	50	Male	1550RMA-ND	8.92	7.70	5.24	112-050-103L011
2	50	Female	1550RFA-ND	8.92	7.70	5.24	112-050-203L011
3	50	Female	1550LFA-ND	8.92	7.70	5.24	112-050-203L021
4	50	Male	1550LMA-ND	9.46	8.16	5.55	112-050-103L021

**955 Series – Quick Lock and Quick Release Post Kits**

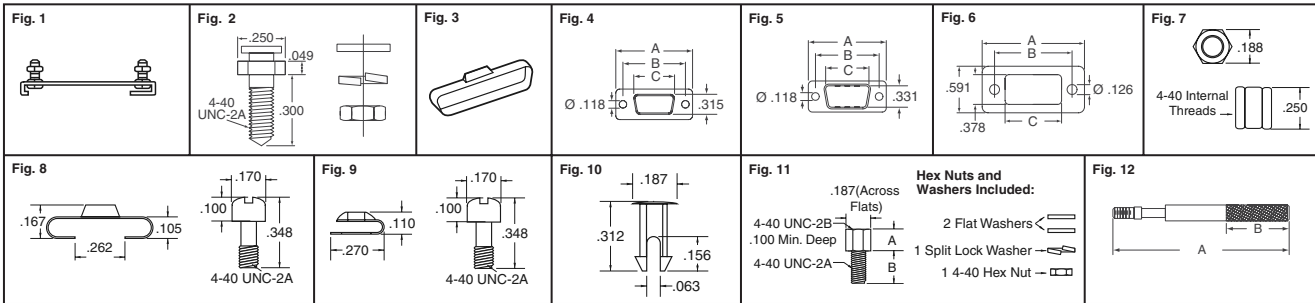

Fig.	Description	Dim. - Inch			Digi-Key Part No.	Price Each			NorComp Part No.
		A	B	C		1	10	100	
<b>Slide Lock Posts for Ethernet Hood (980, 981 and 994 Series)</b>									
1	9-Pin, D-Sub or Ethernet	—	—	—	160-099SL-ND	1.77	1.53	1.04	160-009-002-031
	9-Pin, D-Sub or Ethernet	—	—	—	160-099SLA-ND	1.78	1.54	1.05	160-009-002R031
	15-Pin, D-Sub or Ethernet	—	—	—	T2040A-ND	1.42	1.22	83	160-015-003R031
	25-Pin, D-Sub or Ethernet	—	—	—	160-25SLA-ND	2.12	1.83	1.25	160-025-004R031
2	2 Connectors Required	—	—	—	T2042A-ND	.74	.64	.44	160-000-005R031
<b>Dust Cover</b>									
3	Female, 9-Position D-Sub	—	—	—	909DCA-ND	.57	.49	.34	160-000-209R000
	Female, 15-Position D-Sub	—	—	—	915DCA-ND	.86	.75	.51	160-000-215R000
	Female, 25-Position D-Sub	—	—	—	925DCA-ND	.55	.48	.33	160-000-225R000
	Female, 37-Position D-Sub	—	—	—	160-37FA-ND	.71	.61	.42	160-000-237R000
	Female, 50-Position D-Sub	—	—	—	160-50F-ND	.75	.65	.45	160-000-250-000
	Female, 50-Position D-Sub	—	—	—	160-50FA-ND	.80	.69	.47	160-000-250R000
3	Male, 9-Position D-Sub	—	—	—	160-09MA-ND	.58	.51	.35	160-000-109R000
	Male, 15-Position D-Sub	—	—	—	160-15MA-ND	.58	.51	.35	160-000-115R000
	Male, 25-Position D-Sub	—	—	—	160-25M-ND	.55	.48	.33	160-000-125-000
	Male, 25-Position D-Sub	—	—	—	160-25MA-ND	.61	.53	.37	160-000-125R000
	Male, 37-Position D-Sub	—	—	—	160-37MA-ND	.71	.61	.42	160-000-137R000
	Male, 50-Position D-Sub	—	—	—	160-50MA-ND	.80	.69	.47	160-000-150R000
<b>Shielded Dust Cover</b>									
3	Female, 9-Position D-Sub	—	—	—	160-209F-ND	3.13	2.70	1.84	160-020-209-000
	Female, 9-Position D-Sub	—	—	—	160-209FA-ND	3.66	3.16	2.15	160-020-209R000
	Female, 15-Position D-Sub	—	—	—	160-215F-ND	3.28	2.83	1.93	160-020-215-000
	Female, 15-Position D-Sub	—	—	—	160-215FA-ND	3.81	3.29	2.24	160-020-215R000
	Female, 25-Position D-Sub	—	—	—	160-225F-ND	3.54	3.05	2.08	160-020-225-000
	Female, 25-Position D-Sub	—	—	—	160-225FA-ND	4.12	3.55	2.42	160-020-225R000
3	Male, 9-Position D-Sub	—	—	—	160-209M-ND	2.87	2.48	1.69	160-020-109-000
	Male, 9-Position D-Sub	—	—	—	160-209MA-ND	3.04	2.63	1.79	160-020-109R000
	Male, 15-Position D-Sub	—	—	—	160-215M-ND	3.50	3.02	2.06	160-020-115R000
	Male, 25-Position D-Sub	—	—	—	160-225M-ND	3.22	2.78	1.89	160-020-125-000
	Male, 25-Position D-Sub	—	—	—	160-225MA-ND	3.75	3.24	2.20	160-020-125R000
	<b>Cover Flange — RoHS Compliant</b>								
4	Female, 9-Position D-Sub	1.209	.984	.642	CF09S-ND	2.54	1.72	1.33	CF09S
	Female, 15-Position D-Sub	1.535	1.312	.969	CF15S-ND	2.69	1.77	1.43	CF15S
	Female, 25-Position D-Sub	2.083	1.852	1.512	CF25S-ND	2.73	1.85	1.50	CF25S
	Female, 37-Position D-Sub	2.728	2.500	2.157	CF37S-ND	3.24	2.16	1.77	CF37S
	Female, 50-Position D-Sub	2.626	2.406	2.059	CF50S-ND	3.54	2.44	1.99	CF50S
	Male, 9-Position D-Sub	1.205	.984	.669	CF09P-ND	2.54	1.72	1.33	CF09P
Male, 15-Position D-Sub	1.535	1.312	.996	CF15P-ND	2.69	1.77	1.43	CF15P	

Fig.	Description	Dim. - Inch			Digi-Key Part No.	Price Each			NorComp Part No.		
		A	B	C		1	10	100			
5	Male, 25-Position D-Sub	2.079	1.852	1.535	CF25P-ND	2.73	1.85	1.50	CF25P		
	Male, 37-Position D-Sub	2.724	2.500	2.181	CF37P-ND	3.24	2.16	1.77	CF37P		
	Male, 50-Position D-Sub	2.626	2.406	2.079	CF50P-ND	3.54	2.44	1.99	CF50P		
<b>Silicon Sealing Flange — RoHS Compliant</b>											
6	9-Position	1.299	.984	.717	SF09-ND	1.04	.68	.49	SF09		
	15-Position	1.614	1.311	1.039	SF15-ND	1.25	.80	.58	SF15		
	25-Position	2.165	1.850	1.583	SF25-ND	1.33	.82	.62	SF25		
	37-Position	2.835	2.500	2.228	SF37-ND	1.48	.96	.70	SF37		
<b>4-40 Female Coupling Nut — RoHS Compliant</b>											
7	Brass Finish, Yellow Chromate Plated	—	—	—	160-106YCA-ND	.38	.22	.14	160-000-006R042		
	Brass Finish, Nickel Plated	—	—	—	160-06YCA-ND	.19	.16	.11	160-000-006R032		
<b>4-40 Male Screwlock with Slip-On Retainer — RoHS Compliant</b>											
8	Steel Finish, Nickel Plated	—	—	—	160-01MYCA-ND	1.20	1.04	.71	160-000-001R031		
<b>4-40 Male Screwlock with Clip-On Retainer (2 screws, 2 clips) — RoHS Compliant</b>											
9	Screw - Steel, Nickel Plated, Clip - Stainless Steel	—	—	—	160-02MA-ND	.86	.75	.51	160-000-002R031		
<b>Plastic Clips for Retaining Connectors to PC .062" Board</b>											
10	Nylon	—	—	—	163-01P-ND	25	.15	.11	163-001-000-000		
<b>4-40 Female Screwlock Assembly — RoHS Compliant</b>											
11	Steel Finish, Nickel Plated	.187	.312	—	160-10FA-ND	.74	.64	.44	160-000-010R031		
		.187	.625	—	160-11FA-ND	.98	.85	.58	160-000-011R031		
		.250	.156	—	160-12FA-ND	.80	.69	.47	160-000-012R031		
		.197	.197	—	160-13FA-ND	.71	.61	.42	160-000-013R031		
		.197	.236	—	160-14FA-ND	.68	.59	.40	160-000-014R031		
		.197	.323	—	160-15FA-ND	.68	.59	.40	160-000-015R031		
11	Steel Finish, Nickel Plated	.197	.433	—	160-16FA-ND	.80	.69	.47	160-000-016R031		
		.197	.520	—	160-17FA-ND	.68	.59	.40	160-000-017R031		
		.197	.669	—	160-18FA-ND	.96	.83	.56	160-000-018R031		
		<b>4-40 Female Screwlock — RoHS Compliant</b>									
		11	Steel Finish, Nickel Plated	.187	.312	—	SFS04401NR-ND	.45	.26	.17	SFS04401NR
				.197	.197	—	SFS04404NR-ND	.45	.26	.17	SFS04404NR
<b>4-40 Thumbscrew — Steel Finish, Nickel Plated — RoHS Compliant</b>											
12	For 977/ 978/ 979 Series Backshells	1.75	.625	—	160-02TSA-ND	25	.22	.15	160-000-050R031		
<b>M2.6 Thumbscrew — Steel Finish, Nickel Plated — RoHS Compliant</b>											
12	For 970/ 972 Series Backshells	1.811	.360	—	160-03TSA-ND	.74	.64	.44	160-000-060R031		
<b>Tool</b>											
—	Insertion/Removal Tool	—	—	—	T2020-ND	9.07	—	—	180-901-170-000		

♦ RoHS Compliant † Hex Nuts and Washers NOT Included

## Parallel Interface Connectors (Centronics Type)

Material: • Insulator: Glass filled thermoplastic, UL 94V-0 rated • Shell: Steel, Nickel plated • Contacts: Copper alloy, 10µ gold over 30µ nickel

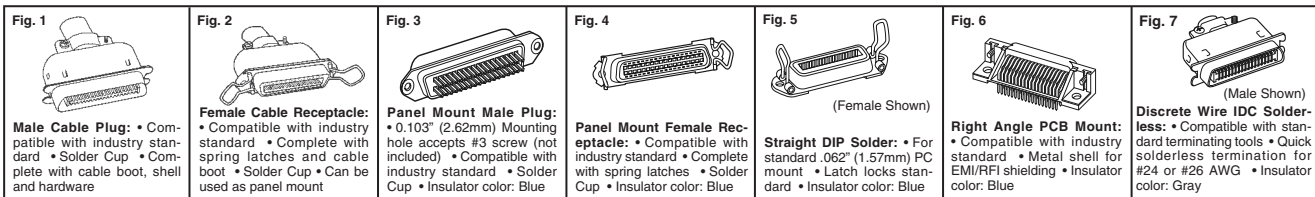

Fig.	No. of Contacts	Type	Digi-Key Part No.	Price Each			NorComp Part No.
				1	10	100	
1	14	Male	T1501A-ND	3.94	3.40	2.31	110-014-103L001
	36		T1503A-ND	4.00	3.45	2.35	110-036-103L001
	50		T1504A-ND	7.08	6.11	4.16	110-050-103L001
2	14	Female	T1507A-ND	4.45	3.84	2.62	110-014-203L001
	36		T1509A-ND	5.05	4.36	2.97	110-036-203L001
	50		T1510A-ND	7.80	6.72	4.57	110-050-203L001
3	14	Male	1014M-ND	2.51	2.16	1.47	111-014-103-001
	14		1014MA-ND	2.72	2.35	1.60	111-014-103L001
	24		1024M-ND	2.69	2.33	1.58	111-024-103-001
	24		1024MA-ND	2.92	2.52	1.72	111-024-103L001
	36		1036M-ND	2.61	2.26	1.54	111-036-103-001
	36		1036MA-ND	2.83	2.44	1.66	111-036-103L001
4	14	Female	1014F-ND	4.26	3.70	2.52	111-050-103L001
	24		1024F-ND	2.86	2.47	1.68	111-014-203L001
	24		1024FA-ND	4.26	3.68	2.50	111-024-203-001
	24		1024FMA-ND	4.70	4.06	2.76	111-024-203L001
	36		1036F-ND	3.39	2.93	1.99	111-036-203L001
	50		1050F-ND	5.36	4.62	3.14	111-050-203L001
5	14	Male	1014PMA-ND	3.38	2.92	1.99	111-014-113L001
	24		1024PMA-ND	4.52	3.90	2.66	111-024-113-001
	24		1024PMA-ND	5.14	4.44	3.02	111-024-113L001
	36		1036PMA-ND	4.88	4.21	2.86	111-036-113-001

Fig.	No. of Contacts	Type	Digi-Key Part No.	Price Each			NorComp Part No.
				1	10	100	
5	36	Male	1036PMA-ND	5.55	4.79	3.26	111-036-113L001
	50		1050PMA-ND	6.21	5.35	3.64	111-050-113L001
	14		1014PFA-ND	3.13	2.70	1.84	111-014-213L001
	24		1024PFA-ND	2.97	2.57	1.75	111-024-213-001
	24		1024PFA-ND	3.38	2.92	1.99	111-024-213L001
	36		1036PFA-ND	4.98	4.30	2.92	111-036-213L001
6	14	Male	1050PFA-ND	7.72	6.66	4.53	111-050-213L001
	14		1014RM-ND	3.18	2.74	1.87	112-014-113-001
	14		1014RMA-ND	5.33	3.90	3.18	112-014-113R001
	24		1024RM-ND	3.58	3.09	2.10	112-024-113-001
	24		1024RMA-ND	4.92	3.50	2.87	112-024-113R001
	36		1036RMA-ND	6.04	5.21	3.55	112-036-113R001
6	14	Female	1050RM-ND	6.39	5.51	3.75	112-050-113-001
	14		1050RMA-ND	7.26	6.27	4.26	112-050-113R001
	14		1014RF-ND	3.69	3.19	2.17	112-014-213-001
	14		1014RFA-ND	5.43	3.98	3.24	112-014-213R001
	24		1024RFA-ND	5.09	3.70	2.96	112-024-213R001
	36		1036RFA-ND	5.30	4.58	3.11	112-036-213R001
7	50	Male	1050RF-ND	6.68	5.76	3.92	112-050-213-001
	50		1050RFA-ND	7.60	6.56	4.46	112-050-213R001
	36		1036CM-ND	10.18	8.78	5.97	110-036-193-001

♦ RoHS Compliant

More Product Available Online: [www.digkey.com](http://www.digkey.com)

Toll-Free: 1-800-344-4539 • Phone 218-681-6674 • Fax: 218-681-3380