

Fig. 6 – 0603 Lentille à dôme, sans conducteur

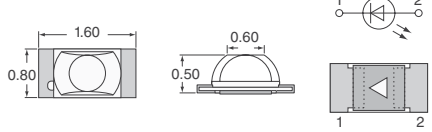

Fig. 7 – Type J-conducteur-S

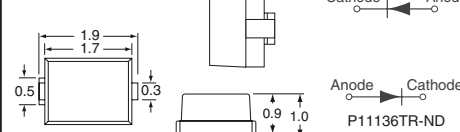

Fig. 8 – Type S Gull Wing

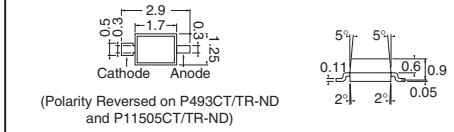

Fig. 9 – 1206 (3216) Sans conducteur de type

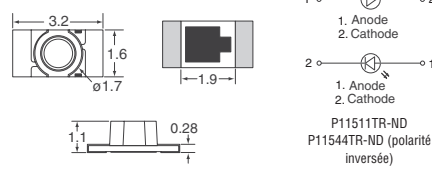

Fig. 10 – 1206 (3216) Type sans conducteur, lentille à dôme 30°

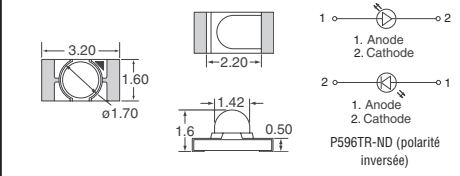

Fig. 11 – Vue côté sans conducteur

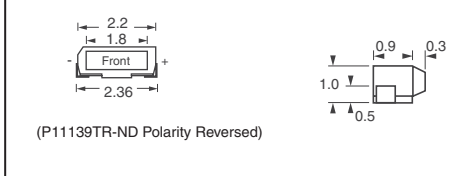

Fig.	Couleur de lumière	Lentille	Tech. de processus	Valeurs nominales max. absolues			Es		I _F nominal (mA)	V _F (V)		λP Typ.	N° de référence Digi-Key bande coupée	Prix unitaire			N° de référence Digi-Key	Bande et bobine		N° de référence Panasonic	
				PD (mW)	I _F (mA)	V _R (V)	Topr (°C)	Type (mcd)		Min. (mcd)	Typique			Max.	1	10		100	Qté		Prix
7	Jaune vert	Vert diffus	GaP	60	20	4	-25 - 85	2.6	0.9	10	2.03	2.6	565	P11137CT-ND	.28	26	24	P11137TR-ND	6,000	83.86/M	LNJ306GSURA
	Vert pur	Vert diffus	GaP	60	20	4	-25 - 85	0.65	0.25	10	2.03	2.6	555	P11493CT-ND	.32	29	26	P11493TR-ND	6,000	95.72/M	LNJ306GSPRX
DEL InGaAlP à forte luminosité																					
7	Orange	Rouge diffus	InGaAlP	50	20	4	-25 - 85	5	2	10	1.9	2.3	620	P11494CT-ND	.44	36	27	P11494TR-ND	6,000	112.86/M	LNJ806R58RX
	Ambre	Jaune diffus	InGaAlP	50	20	4	-25 - 85	8.5	3.5	10	2	2.3	595	P11495CT-ND	.44	36	27	P11495TR-ND	6,000	112.86/M	LNJ406K54RX
0805 (2012) Type J- connecteur S-J guipage à pas de 4 mm																					
7	Rouge	Rouge diffus	GaP	60	20	4	-25 - 85	0.4	0.15	10	2.03	2.6	700	P11496CT-ND	.28	26	23	P11496TR-ND	3,000	91.48/M	LNJ206R5RUX
	Rouge très lumineux	Rouge diffus	GaAlAs	60	20	3	-25 - 85	5	1.7	5	1.72	2.5	660	P11497CT-ND	.32	29	26	P11497TR-ND	3,000	105.03/M	LNJ206R5AUX
	Orange clair	Jaune diffus	GaAsP	60	20	3	-25 - 85	0.8	0.3	10	1.93	2.6	610	P11498CT-ND	.30	27	24	P11498TR-ND	3,000	96.56/M	LNJ806K5SUX
	Ambre	Jaune diffus	GaAsP	60	20	4	-25 - 85	1	0.4	10	2	2.6	590	P11499CT-ND	.30	27	24	P11499TR-ND	3,000	96.56/M	LNJ406K5YUX
	Jaune vert	Vert diffus	GaP	60	20	4	-25 - 85	3.5	1.35	10	2.03	2.6	565	P11500CT-ND	.28	26	23	P11500TR-ND	3,000	91.48/M	LNJ306G5UUX
	Vert pur	Vert diffus	GaP	60	20	4	-25 - 85	0.65	0.25	10	2.03	2.6	555	P11501CT-ND	.32	29	26	P11501TR-ND	3,000	105.03/M	LNJ306G5PUX
DEL InGaAlP/GaN à forte luminosité																					
7	Orange	Rouge diffus	InGaAlP	50	20	4	-25 - 85	5	2	10	1.9	2.3	620	P11502CT-ND	.44	36	27	P11502TR-ND	3,000	117.73/M	LNJ806R58UX
	Ambre	Jaune diffus	InGaAlP	50	20	4	-25 - 85	8.5	3.5	10	2	2.3	595	P11503CT-ND	.44	36	27	P11503TR-ND	3,000	117.73/M	LNJ406K54UX
	Bleu	Blanc diffus	GaN	40	10	5	-25 - 85	5.5	2	5	3.2	3.7	470	P11504CT-ND	3.52	3.30	3.08	P11504TR-ND	3,000	1605.07/M	LNJ906W5BUX
0805 (2012) Type Gull Wing S-GW, guipage à pas de 2 mm — Conforme à RoHS																					
8	Rouge	Rouge diffus	GaP	60	20	4	-25 - 85	0.4	0.15	10	2.03	2.6	700	P490CT-ND	—	26	24	P490TR-ND	6,000	83.86/M	LN1271RTR
	Rouge à forte luminosité	Rouge diffus	GaAlAs	60	20	3	-25 - 85	5	1.7	10	1.72	2.5	660	P493CT-ND	—	35	32	P493TR-ND	6,000	95.72/M	LN1271RALTR
	Orange	Rouge diffus	GaAsP	30	10	3	-30 - 85	1	0.4	5	1.8	2.4	630	P518CT-ND	.28	26	24	P518TR-ND	6,000	100.80/M	LN1871SRTR
	Orange clair	Jaune diffus	GaAsP	60	20	3	-25 - 85	0.8	0.3	10	1.93	2.6	610	P492CT-ND	—	27	24	P492TR-ND	6,000	88.09/M	LN1871YSTR
	Ambre	Jaune diffus	GaAsP	60	20	4	-25 - 85	1	0.4	10	2	2.6	590	P1125CT-ND	.30	28	26	P1125TR-ND	6,000	88.09/M	LN1471YTR
	Ambre	Jaune diffus	GaAsP	30	10	4	-30 - 85	1	0.4	5	1.9	2.4	590	P517CT-ND	.28	26	24	P517TR-ND	6,000	100.80/M	LN1471SYTR
	Jaune vert	Vert diffus	GaP	60	20	4	-25 - 85	2.6	0.9	10	2.03	2.6	565	P491CT-ND	—	26	24	P491TR-ND	6,000	83.86/M	LN1371GTR
	Jaune vert	Vert diffus	GaP	30	10	4	-30 - 85	2	0.7	5	1.9	2.4	565	P516CT-ND	.28	26	24	P516TR-ND	6,000	95.72/M	LN1371SGTR
	Vert très lumineux	Vert diffus	GaP	60	20	4	-25 - 85	5	3	10	2.03	2.6	565	P494CT-ND	—	28	25	P494TR-ND	6,000	87.25/M	LNJ306G5TR02
	0805 (2012) Type Gull Wing S-GW, guipage à pas de 4 mm																				
8	Rouge à forte luminosité	Rouge diffus	GaAlAs	60	20	3	-25 - 85	5	1.7	10	1.72	2.5	660	P11505CT-ND	.32	29	26	P11505TR-ND	3,000	105.03/M	LN1271RALTRP
	Rouge à forte luminosité	Rouge diffus	GaAsP	30	10	3	-30 - 85	1	0.4	5	1.8	2.4	630	P11506CT-ND	.31	28	25	P11506TR-ND	3,000	100.80/M	LN1871SRTRP
	Orange clair	Jaune diffus	GaAsP	60	20	3	-25 - 85	0.8	0.3	10	1.93	2.6	610	P11507CT-ND	.30	27	24	P11507TR-ND	3,000	96.56/M	LN1871YSTRP
	Ambre	Jaune diffus	GaAsP	30	10	4	-30 - 85	1	0.4	5	1.9	2.4	590	P11508CT-ND	.30	27	24	P11508TR-ND	3,000	96.56/M	LN1471SYTRP
	Jaune vert	Vert diffus	GaP	60	20	4	-25 - 85	2.6	0.9	10	2.03	2.6	565	P11509CT-ND	.28	26	23	P11509TR-ND	3,000	91.48/M	LN1371GTRP
	Jaune vert	Vert diffus	GaP	30	10	4	-25 - 85	2	0.7	5	1.9	2.4	565	P11510CT-ND	.30	27	24	P11510TR-ND	3,000	95.71/M	LN1371SGTRP
1206 (3216) Sans conducteur avec type de lentille plate — Conforme à RoHS																					
9	Rouge très lumineux	Rouge diffus	GaAlAs	60	20	3	-30 - 85	7	2.3	10	1.72	2.5	660	P11141CT-ND	.28	26	24	P11141TR-ND	3,000	116.89/M	LNJ211R8ARA
	Orange	Rouge diffus	GaAsP	60	20	3	-30 - 85	1.8	0.7	10	1.93	2.6	630	P11526CT-ND	.33	30	27	P11526TR-ND	3,000	108.42/M	LNJ811R8DRA
	Orange clair	Jaune diffus	GaAsP	60	20	3	-30 - 85	1	0.5	10	1.93	2.6	610	P11527CT-ND	.33	30	27	P11527TR-ND	3,000	108.42/M	LNJ811R8SRA
	Ambre	Jaune diffus	GaAsP	60	20	4	-30 - 85	2.2	0.75	10	2	2.6	590	P11528CT-ND	.33	30	27	P11528TR-ND	3,000	108.42/M	LNJ411K8YRA
	Jaune vert	Vert diffus	GaP	60	20	4	-30 - 85	5.5	1.8	10	2.03	2.6	565	P11529CT-ND	.30	28	25	P11529TR-ND	3,000	99.95/M	LNJ311G8TRA
	Vert pur	Vert diffus	GaP	60	20	4	-30 - 85	0.7	0.25	10	2.03	2.6	555	P11531CT-ND	.36	32	29	P11531TR-ND	3,000	116.89/M	LNJ311G8PRA
	Rouge très lumineux	Rouge diffus	GaAlAs	60	20	3	-30 - 85	7	2.3	10	1.72	2.5	660	P541CT-ND	.28	26	24	P541TR-ND	3,000	116.89/M	LNJ211R8ARA
	Orange	Rouge diffus	GaAsP	60	20	3	-30 - 85	1.8	0.7	10	1.93	2.6	630	P11540CT-ND	.33	30	27	P11540TR-ND	3,000	108.42/M	LNJ811R8DRU
	Ambre	Jaune diffus	GaAsP	60	20	4	-30 - 85	2.2	0.75	10	2	2.6	590	P11596CT-ND	.33	30	27	P11596TR-ND	3,000	108.42/M	LNJ411K8YRU
	Jaune vert	Vert diffus	GaP	60	20	4	-30 - 85	5.5	1.8	10	2.03	2.6	565	P540CT-ND	.28	26	24	P540TR-ND	3,000	99.95/M	LNJ311G8TRU
DEL InGaAlP/GaN à forte luminosité																					
9	Rouge à forte luminosité	Rouge diffus	InGaAlP	55	20	4	-30 - 85	15	8	10	1.92	2.5	645	P11532CT-ND	.40	32	24	P11532TR-ND	3,000	105.44/M	LNJ211R82RA
	Orange	Rouge diffus	InGaAlP	55	20	4	-30 - 85	32	17	10	2.03	2.5	630	P11533CT-ND	.35	28	21	P11533TR-ND	3,000	91.98/M	LNJ811R83RA
	Orange	Rouge diffus	InGaAlP	50	20	4	-30 - 85	6.5	3.5	10	1.9	2.5	620	P11534CT-ND	.48	39	29	P11534TR-ND	3,000	128.31/M	LNJ811R88RA
	Orange clair	Rouge diffus	InGaAlP	55	20	4	-30 - 85	21	10	10	1.95	2.5	615	P11535CT-ND	.35	28	21	P11535TR-ND	3,000	91.98/M	LNJ811K87RA
	Ambre	Jaune diffus	InGaAlP	55	20	4	-30 - 85	17	9	10	2	2.5	595	P11536CT-ND	.48	39	29	P11536TR-ND	3,000	127.69/M	LNJ411K84RA
	Jaune vert	Vert diffus	InGaAlP	55	20	4	-30 - 85	12	6.4	10	2.03	2.5	575	P11537CT-ND	.35	28	21	P11537TR-ND	3,000	91.98/M	LNJ311G83RA
	Bleu	Blanc diffus	GaN	40	10	5	-25 - 85	8.5	4.5	5	3.2	3.7	470	P11539CT-ND	.55	42	32	P11539TR-ND	3,000	179.98/M	LNJ911W8BRA
	Vert pur	Blanc diffus	GaN	40	10	5	-25 - 85	34	14.4	5	3	3.7	525	P11538CT-ND	.70	59	48	P11538TR-ND	3,000	305.62/M	LNJ611W8WRA
	Ambre	Jaune diffus	InGaAlP	55	20	4	-30 - 85	17	9	10	2	2.5	595	P11541CT-ND	.48	39	29	P11541TR-ND	3,000	127.69/M	LNJ411K84RU
	Bleu	Blanc diffus	GaN	40	10	5	-25 - 85	8.5	4.5	5	3.2	3.7	470	P11543CT-ND	.55	42	32	P11543TR-ND	3,000	179.98/M	LNJ911W8BRU
Vert pur	Blanc diffus	GaN	40	10	5	-25 - 85	34	14.4	5	3	3.7	525	P11542CT-ND	.70	59	48	P11542TR-ND	3,000	305.62/M	LNJ611W8WRU	
1206 (3216) Sans conducteur avec type de micro-lentille — Conforme à RoHS																					
9	Rouge très lumineux	Rouge diffus	GaAlAs	60	20	3	-30 - 85	10.5	4	10	1.72	2.5	660	P11511CT-ND	.36	32	29	P11511TR-ND	3,000	116.89/M	LNJ216C8ARA
	Orange	Transp. non diffus																			

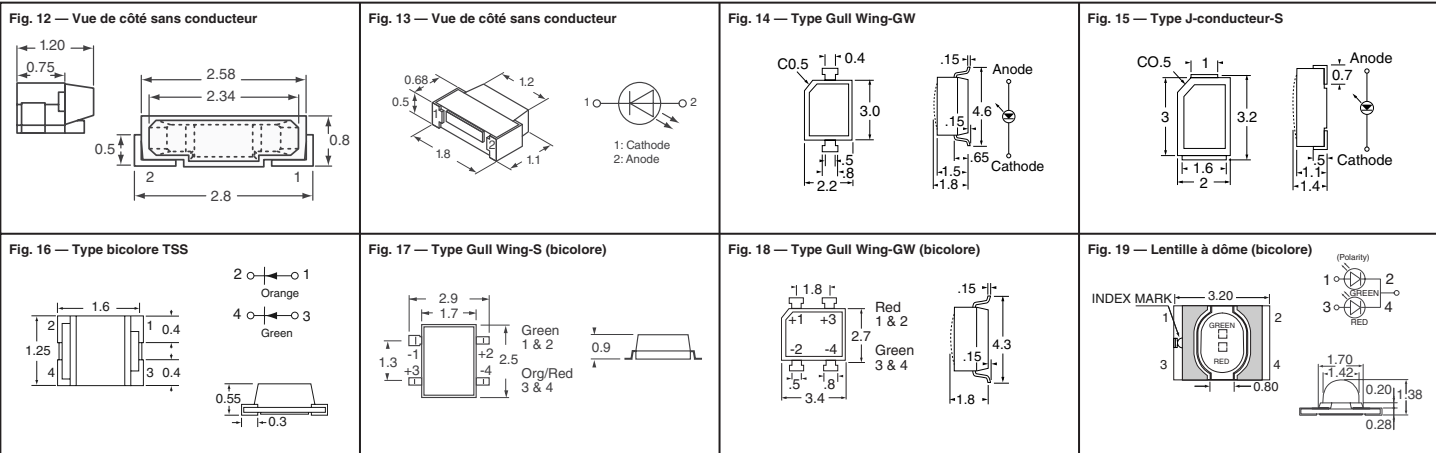

Fig.	Couleur de lumière	Lentille	Tech. de processus	Valeurs nominales max. absolues				E _s		I _f		V _f (V)	λP	N° de référence Digi-Key	Prix unitaire de bande coupée			N° de référence Digi-Key	Bande et bobine		N° de référence Panasonic
				PD (mW)	(mA) I _F	(V) V _R	Topr (°C)	Typ. (mcd)	Min. (mcd)	nominal (mA)	Typique				Max.	1	10		100	Qté	
9	Ambre	Transp. non diffus	InGaAlP	55	20	4	-30 - 85	26	13.8	10	2	2.5	595	P11522CT-ND	.48	.39	.29	P11522TR-ND	3,000	127.69/M	LNJ416C84RA
	Jaune vert	Transp. non diffus	InGaAlP	55	20	4	-30 - 85	22	11	10	2.03	575	P11523CT-ND	.35	.28	.21	P11523TR-ND	3,000	91.98/M	LNJ316C83RA	
	Bleu	Transp. non diffus	GaN	40	10	5	-25 - 85	12.8	6.8	15	3.2	3.7	470	P11525CT-ND	.55	.42	.32	P11525TR-ND	3,000	179.98/M	LNJ916C88RA
	Vert pur	Transp. non diffus	GaN	40	10	5	-25 - 85	5	27.2	5	3	3.7	525	P11524CT-ND	.70	.59	.48	P11524TR-ND	3,000	305.62/M	LNJ616C8WRA
	Jaune vert	Transp. non diffus	InGaAlP	55	20	4	-30 - 85	22	11	10	2.03	2.5	575	P11548CT-ND†	.35	.28	.21	P11548TR-ND†	3,000	91.98/M	LNJ316C83RU
1206 (3216) Sans conducteur avec type de lentille à dôme (30 degrés) — Conforme à RoHS																					
10	Rouge très lumineux	Transparente	GaAlAs	60	20	3	-30 - 85	32	17	10	1.72	2.5	660	P596CT-ND	.62	.57	.52	P596TR-ND	2,000	166.18/M	LNJ218C84RA
	Orange	Transp. non diffus	GaAsP	60	20	3	-30 - 85	9	4.5	20	1.93	2.6	630	P11563CT-ND	.42	.40	.36	P11563TR-ND	2,000	171.10/M	LNJ818C8DRA
	Orange clair	Transp. non diffus	GaAsP	60	20	3	-30 - 85	5	2.7	20	1.93	2.6	610	P11564CT-ND	.42	.40	.36	P11564TR-ND	2,000	171.10/M	LNJ818C8SRA
	Jaune vert	Transparente	GaP	60	20	4	-30 - 85	25	10	10	2.03	2.6	565	P595CT-ND	.47	.44	.40	P595TR-ND	2,000	150.72/M	LNJ318C8TRA
	Ambre	Jaune transp. non diff.	GaAsP	60	20	4	-30 - 85	7	3.7	20	2	2.6	590	P11565CT-ND	.42	.40	.36	P11565TR-ND	2,000	171.10/M	LNJ418Q8YRA
	Vert pur	Transp. non diffus	GaP	60	20	4	-30 - 85	3.5	2	20	2.03	2.6	555	P11567CT-ND	.44	.42	.38	P11567TR-ND	2,000	179.57/M	LNJ318C8PRA
	Rouge très lumineux	Transp. non diffus	GaAlAs	60	20	3	-30 - 85	32	17	20	1.72	2.5	660	P11576CT-ND	.44	.42	.38	P11576TR-ND	2,000	179.57/M	LNJ218C8ARU
	Orange clair	Transp. non diffus	GaAsP	60	20	3	-30 - 85	5	2.7	10	1.03	2.6	610	P11577CT-ND	.42	.40	.36	P11577TR-ND	2,000	171.10/M	LNJ818C8SRU
Ambre	Jaune transp. non diff.	GaAsP	60	20	4	-30 - 85	7	3.7	20	2	2.6	590	P11578CT-ND	.42	.40	.36	P11578TR-ND	2,000	171.10/M	LNJ418Q8YRU	
DEL InGaAlP forte luminosité																					
10	Rouge à forte luminosité	Transp. non diffus	InGaAlP	55	20	4	-30 - 85	75	40	20	1.92	2.5	645	P11568CT-ND	.44	.33	.25	P11568TR-ND	2,000	146.62/M	LNJ218C82RA
	Orange	Non diffus	InGaAlP	55	20	4	-30 - 85	160	85	20	2.03	2.5	630	P11569CT-ND	.48	.39	.29	P11569TR-ND	2,000	134.47/M	LNJ818C83RA
	Orange	Transp. non diffus	InGaAlP	55	20	4	-30 - 85	33	17.6	20	1.9	2.5	620	P11570CT-ND	.53	.41	.31	P11570TR-ND	2,000	178.22/M	LNJ818C88RA
	Orange clair	Transp. non diffus	InGaAlP	55	20	4	-30 - 85	100	56	20	1.95	2.5	615	P11571CT-ND	.48	.39	.29	P11571TR-ND	2,000	134.47/M	LNJ818C87RA
	Ambre	Transp. non diffus	InGaAlP	55	20	4	-30 - 85	85	45	20	2	2.5	595	P11572CT-ND	.53	.41	.31	P11572TR-ND	2,000	178.22/M	LNJ418C84RA
	Jaune vert	Transp. non diffus	InGaAlP	55	20	4	-30 - 85	110	58	20	2.03	2.5	575	P11573CT-ND	.48	.39	.29	P11573TR-ND	2,000	134.47/M	LNJ318C83RA
Jaune vert	Transp. non diffus	InGaAlP	55	20	4	-30 - 85	110	58	10	2.03	2.5	575	P11579CT-ND†	.48	.39	.29	P11579TR-ND†	2,000	134.47/M	LNJ318C83RU	
DEL à allumage sur le côté avec boîtier de réfraction																					
11	Rouge	Transparente	GaP	60	20	4	-25 - 80	0.7	0.25	10	2.03	2.6	700	P11138CT-ND◆	.34	.32	.29	P11138TR-ND◆	3,000	138.06/M	LNJ210C6RRA
	Rouge très lumineux	Transparente	GaAlAs	60	20	3	-25 - 80	8	2.6	10	1.72	2.5	660	P11139CT-ND◆	.34	.32	.29	P11139TR-ND◆	3,000	154.16/M	LNJ210C6ARA
	Orange	Rouge clair	GaAsP	60	20	3	-25 - 80	2.5	0.8	10	1.93	2.6	630	P519CT-ND◆	.33	.31	.28	P519TR-ND◆	3,000	145.69/M	LNJ810L6DRA
	Orange clair	Rouge transp. non diff.	GaAsP	60	20	3	-25 - 85	1.8	0.75	10	1.93	2.6	610	P11580CT-ND	.45	.41	.37	P11580TR-ND	3,000	145.69/M	LNJ810L6SRA
	Ambre	Jaune clair	GaAsP	60	20	4	-25 - 80	2.5	0.8	10	2	2.6	590	P11140CT-ND◆	.34	.32	.29	P11140TR-ND◆	3,000	145.69/M	LNJ410Q6YRA
	Jaune vert	Transparente	GaP	60	20	4	-25 - 80	8	3	10	2.03	2.6	565	P520CT-ND◆	.33	.31	.28	P520TR-ND◆	3,000	138.06/M	LNJ310M6URA
	Vert pur	Transp. non diffus	GaP	60	20	4	-25 - 85	1.1	0.6	10	2.03	2.6	555	P11582CT-ND	.47	.43	.39	P11582TR-ND	3,000	154.16/M	LNJ310C6PRA
Blanc	Blanc diffus	GaN	120	30	5	-25 - 80	260	180	10	3.4	3.9	—	P12024CT-ND	4.89	4.56	4.13	—	—	—	LNJ010X6FRA	
DEL InGaAlP forte luminosité																					
11	Rouge à forte luminosité	Transp. non diffus	InGaAlP	55	20	4	-25 - 85	23	12	10	1.92	2.5	645	P11583CT-ND◆	.61	.58	.52	P11583TR-ND◆	3,000	248.17/M	LNJ210C62RA
	Orange	Transp. non diffus	InGaAlP	55	20	4	-25 - 85	48	25	10	2.03	2.5	630	P11584CT-ND	.61	.58	.52	P11584TR-ND	3,000	248.17/M	LNJ810C63RA
	Orange	Transp. non diffus	InGaAlP	55	20	4	-25 - 85	45	24	10	1.95	2.5	620	P11585CT-ND	.61	.58	.52	P11585TR-ND	3,000	248.17/M	LNJ810C68RA
	Orange clair	Transp. non diffus	InGaAlP	50	20	4	-25 - 80	30	12	10	1.95	2.5	615	P11586CT-ND	.61	.58	.52	P11586TR-ND	3,000	248.17/M	LNJ810C67RA
	Ambre	Transp. non diffus	InGaAlP	50	20	4	-25 - 80	22.5	8.5	10	2	2.5	595	P11587CT-ND	.61	.58	.52	P11587TR-ND	3,000	248.17/M	LNJ410C64RA
	Jaune vert	Transp. non diffus	InGaAlP	50	20	4	-25 - 80	15	7.7	10	2	2.5	575	P11588CT-ND	.61	.58	.52	P11588TR-ND	3,000	248.17/M	LNJ310C63RA
Vue de côté — Conforme à RoHS																					
12	Lumière blanche	—	GaN	120	35	5	-30 - 85	—	1440	20	2.8	3.6	—	P14142CT-ND	.81	.68	.55	P14142TR-ND	3,000	352.91/M	LNJ080V6BRA
Vue de côté, sans conducteur — Conforme à RoHS																					
13	Rouge	Blanc diffus	InGaAlP	55	60	4	-30 - 85	15	8.0	10	1.92	2.5	645	P14131CT-ND	.35	.32	.29	P14131TR-ND	5,000	103.35/M	LNJ253W82RA
	Vert	Blanc diffus	InGaAlP	55	60	4	-30 - 85	8.5	4.0	5	1.95	2.30	575	P14132CT-ND	.30	.28	.25	P14132TR-ND	5,000	90.13/M	LNJ353W83RA
	Ambre	Blanc diffus	InGaAlP	55	60	4	-30 - 85	18.0	6.0	5	1.95	2.30	595	P14133CT-ND	.30	.28	.25	P14133TR-ND	5,000	90.13/M	LNJ453W82RA
	Orange	Blanc diffus	InGaAlP	55	60	4	-30 - 85	17.0	9.0	5	1.9	2.3	630	P14134CT-ND	.30	.28	.25	P14134TR-ND	5,000	90.13/M	LNJ853W83RA
	Bleu	Blanc diffus	InGaN	55	70	5	-30 - 85	10.0	7.0	5	2.90	3.20	465	P14135CT-ND	.61	.55	.49	P14135TR-ND	5,000	180.26/M	LNJ953W8CRA
	Blanc	—	GaN	40	10	5	-30 - 85	50	38	5	3.1	3.7	—	P14136CT-ND	.65	.49	.37	P14136TR-ND	5,000	207.67/M	LNJ053X8BRA3
Type Gull Wing GW avec boîtier de réfraction																					
14	Rouge	Transparente	GaP	60	20	4	-25 - 80	1.4	0.5	15	2.2	2.8	700	P503CT-ND◆	.28	.26	.24	P503TR-ND◆	2,000	108.42/M	LN1261CTR
	Rouge très lumineux	Transparente	GaAlAs	50	20	3	-25 - 80	12	5	20	1.8	2.6	660	P513CT-ND◆	.37	.35	.32	P513TR-ND◆	2,000	125.36/M	LN1261CALTR
	Orange	Transparente	GaAsP	60	20	3	-25 - 80	5	1.9	20	2.1	2.8	630	P505CT-ND◆	.28	.26	.24	P505TR-ND◆	2,000	116.89/M	LN1861CTR
	Ambre	Transparente	GaAsP	60	20	4	-25 - 80	4.5	1.6	20	2.2	2.8	590	P512CT-ND◆	.29	.27	.24	P512TR-ND◆	2,000	116.89/M	LN1461CTR
	Jaune vert	Transparente	GaP	60	20	4	-25 - 80	7.5	2.8	20	2.2	2.8	565	P504CT-ND◆	.28	.26	.24	P504TR-ND◆	2,000	108.42/M	LN1361CTR
	Vert très lumineux	Transparente	GaP	60	20	4	-25 - 80	15	8	20	2.2	2.8	565	P514CT-ND◆	.32	.30	.27	P514TR-ND◆	2,000	108.42/M	LNJ361C3UR01
DEL InGaAlP forte luminosité																					
14	Ambre	Transparente	InGaAlP	50	20	4	-25 - 80	18	6.5	10	2	2.3	595	P11128CT-ND	.49	.45	.41	P11128TR-ND	2,000	233.77/M	LNJ461C34RA
1206 (3216) Type J-conducteur-J avec boîtier de réfraction																					
15	Rouge	Transparente	GaAsP	45	15	4	-25 - 80	1.2	0.45	10	2.1	2.8	700	P500CT-ND◆	.28	.26	.24	P500TR-ND◆	3,000	108.42/M	LN1251CTR
	Rouge très lumineux	Transparente	GaAlAs	45	15	3	-25 - 80	9	3.3	10	1.75	2.6	660	P11126CT-ND◆	.37	.35	.32	P11126TR-ND◆	3,000	125.36/M	LN1251CALTR
	Orange	Transparente	GaAsP	45	15	3	-25 - 80	3.5	1.3	10	0.05	2.8	630	P502CT-ND◆	.28	.26	.24	P502TR-ND◆	3,000	116.89/M	LN1851CTR
	Ambre	Transparente	GaAsP	45	15	4	-25 - 80	2.2	0.8	10	2.1	2.8	590	P511CT-ND◆	.28	.26	.24	P511TR-ND◆	3,000	116.89/M	LN1451CTR
	Jaune vert	Transparente	GaP	45	15	4	-25 - 80	5	1.9	10	2.1	2.8	565	P501CT-ND◆	.28	.26	.				

Fig. 20 — Vue de côté sans conducteur

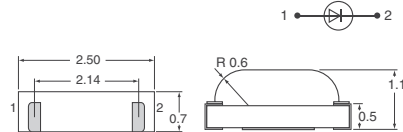

Fig. 21 — Vue de côté sans conducteur (bicolore)

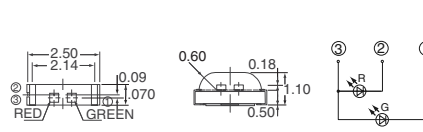

Fig. 22 — Type tricolore TSS

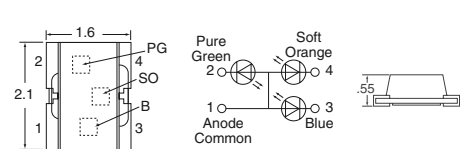

Fig. 23 — Sans conducteur tricolore

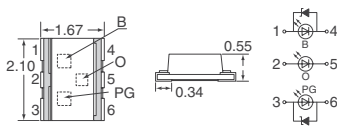

Fig. 24 — Sans conducteur tricolore

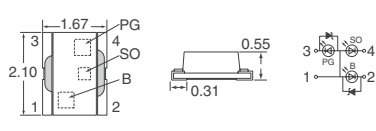

Fig. 25 — Sans conducteur tricolore

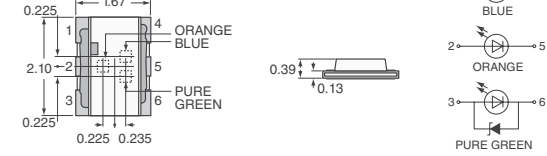

Fig.	Couleur de lumière	Lentille	Valeurs nominales max. absolues	Tech. de processus			E _s		I _f nominal (mA)	V _f (V)		λP Typ.	N° de référence Digi-Key	Prix unitaire de bande coupée			N° de référence Digi-Key	Bande et bobine		N° de référence Panasonic		
				PD (mW)	I _f (mA)	V _R (V)	T fon. (°C)	Type (mcd)		Min. (mcd)	Typique			Max.	1	10		100	Qté		Prix	
16	Vert très lumineux	Blanc diffus	InGaAlP	55	20	4	-30 - 85	15	9	10	2.03	2.5	575	P14161CT-ND	.80	.60	.45	P14161TR-ND	5,000	253.08/M	LNJ115W8RA1	
	Orange très lumineux	Blanc diffus	InGaAlP	55	20	4	-30 - 85	32	17	10	1.95	2.5	630									
Combinaison de DEL InGaAlP/GaN à forte luminosité																						
16	Jaune vert	Blanc diffus	GaP	60	20	4	-30 - 85	5	1.8	10	2.03	2.6	565	P11144CT-ND	.80	.60	.45	P11144TR-ND	5,000	253.08/M	LNJ115W88RA	
	Ambre	Blanc diffus	InGaAlP	55	20	4	-30 - 85	21	7	10	2.1	2.6	595									
	Jaune vert	Blanc diffus	GaP	60	20	4	-30 - 85	5	1.8	10	2.03	2.6	565	P11591CT-ND	.80	.60	.45	P11591TR-ND	5,000	253.08/M	LNJ115W89RA	
	Orange clair	Blanc diffus	InGaAlP	55	20	3	-30 - 85	21	7	10	1.95	2.5	615									
	Vert pur	Blanc diffus	GaN	40	10	5	-30 - 85	34	12.9	5	3	3.7	525	P11590CT-ND	1.58	1.27	.95	P11590TR-ND	5,000	788.40/M	LNJ115W86RA	
	Rouge très lumineux	Blanc diffus	GaAlAs	55	20	3	-30 - 85	6.7	2.8	10	1.72	2.5	655									
	Vert pur	Blanc diffus	GaN	65	15	5	-30 - 85	40	15	5	2.9	3.2	520	P14145CT-ND	.75	.63	.50	P14145TR-ND	5,000	318.58/M	LNJ115W87RA1	
	Rouge	Blanc diffus	InGaAlP	55	20	4	-30 - 85	24	12	10	1.92	2.5	645RA1									
	Bleu	Blanc diffus	GaN	40	10	5	-30 - 85	8.5	4	5	3.2	3.7	470	P11589CT-ND	1.58	1.27	.95	—	—	—	LNJ115W88RA	
	Rouge très lumineux	Blanc diffus	GaAlAs	55	20	3	-30 - 85	6.7	2.8	10	1.72	2.5	655									
	Bleu	Blanc diffus	GaN	65	15	5	-30 - 85	12	5	5	2.9	3.2	465	P14146CT-ND	.75	.63	.50	P14146TR-ND	5,000	318.58/M	LNJ115W85RA1	
	Rouge	Blanc diffus	InGaAlP	55	20	4	-30 - 85	24	12	10	1.92	2.5	645									
Vert pur	Blanc diffus	GaN	40	10	5	-30 - 85	34	10.3	5	3	3.7	525	P11145CT-ND	1.58	1.27	.95	P11145TR-ND	5,000	788.40/M	LNJ115W8VRA		
Orange clair	Blanc diffus	InGaAlP	55	20	4	-30 - 85	21	7	10	1.95	2.5	615										
Vert pur	Blanc diffus	GaN	65	15	5	-30 - 85	40	15	5	2.9	3.2	520	P14147CT-ND	.75	.63	.50	P14147TR-ND	5,000	318.58/M	LNJ115W8VRA1		
Orange clair	Blanc diffus	InGaAlP	55	20	4	-30 - 85	21	8.7	10	1.95	2.5	615										
Gull Wing de type S-GW bicolore — Conforme à RoHS																						
17	Vert très lumineux	Blanc diffus	GaP	60	20	4	-25 - 85	5	3	10	2.03	2.6	565	P526CT-ND	.64	.59	.53	P526TR-ND	3,000	200.74/M	LNJ107W5PRW	
	Jaune vert	Blanc diffus	GaP	60	20	4	-25 - 85	5	3	10	2.03	2.6	565									
	Rouge très lumineux	Blanc diffus	GaAlAs	60	20	3	-25 - 85	5	1.7	10	1.72	2.5	660	P515CT-ND	.64	.59	.53	P515TR-ND	3,000	183.80/M	LNJ107W5ARA1	
	Jaune vert	Blanc diffus	GaP	60	20	4	-25 - 85	2.6	0.9	10	2.03	2.6	565									
Orange	Blanc diffus	GaASP	60	20	3	-25 - 85	1	0.4	10	1.93	2.6	630										
Gull Wing de type bicolore avec boîtier de réfraction																						
18	Vert	Transparente	GaP	45	15	4	-25 - 80	4	1.5	10	2.05	2.8	565	P507CT-ND	.64	.59	.53	P507TR-ND	1,000	216.83	LN2162C13TR	
	Rouge	Transparente	GaASP	45	15	3	-25 - 80	1.8	0.65	10	2	2.8	650									
	Vert pur	Transparente	GaASP	45	15	3	-25 - 65	2.5	1.2	10	2.05	2.8	555	P11147CT-ND	.68	.63	.57	P11147TR-ND	1,000	216.83	LN2162C68TR	
	Orange	Transparente	GaASP	45	15	3	-25 - 65	2.1	0.8	10	1.95	2.8	630									
DEL bicolore sans conducteur, lentille à dôme — Conforme à RoHS																						
19	Jaune/vert	Blanc diffus	GaP	60	20	4	-30 - 85	10	5	10	2.03	2.6	565	P594CT-ND	.45	.41	.38	P594TR-ND	2,500	198.17/M	LNJ121W84RA	
	Rouge très lumineux	Blanc diffus	InGaAlP	55	20	4	-30 - 85	13.4	7	10	1.92	2.5	645									
DEL sans conducteur, taille inférieure, vue latérale — Conforme à RoHS																						
20	Bleu	Blanc diffus	GaN	65	15	5	-30 - 85	25	10	5	3.4	4.67	P632CT-ND	.65	.55	.44	P632TR-ND	4,000	282.33/M	LNJ923W8BRA		
	Bleu	Blanc diffus	InGaN	90	25	5	-30 - 85	18	10	5	2.9	3.2	472	P14150CT-ND	.50	.38	.29	P14150TR-ND	4,000	162.36/M	LNJ923W8CRA1	
	Orange clair	Blanc diffus	InGaAlP	55	20	4	-30 - 85	9	7	5	1.95	2.3	610	P633CT-ND	.36	.29	.20	P633TR-ND	5,000	87.25/M	LNJ853W8BRA	
DEL bicolore sans conducteur, taille inférieure, vue de côté — Conforme à RoHS																						
21	Jaune/vert	Blanc diffus	GaP	60	20	4	-30 - 85	5	1.8	10	2.03	2.6	565	P593CT-ND	.45	.41	.38	P593TR-ND	4,000	198.17/M	LNJ123W8PRZ	
	Rouge très lumineux	Blanc diffus	GaAlAs	50	20	3	-30 - 85	4	1.5	10	1.72	2.5	655									
Combinaison DEL tricolore sans conducteur et DEL à forte luminosité — Conforme à RoHS																						
22	Bleu	Blanc diffus	InGaN	40	10	5	-30 - 85	8.5	3.2	5	3.2	3.7	470	P11146CT-ND	9.42	8.64	7.86	P11146TR-ND	2,000	3839.45/M	LNJ171W80RA	
	Vert pur	Blanc diffus	InGaN	40	10	5	-30 - 85	34	10.3	5	3	3.7	525									
	Orange clair	Blanc diffus	InGaAlP	55	20	4	-30 - 85	23	7	10	1.95	2.5	615									
23	Bleu	Blanc diffus	GaN	65	15	4	-30 - 85	35	10	5	3.1	3.7	470	P11592CT-ND	1.92	1.54	1.16	P11592TR-ND	2,000	999.42/M	LNJ717W83RAS	
	Vert pur	Blanc diffus	GaN	65	15	4	-30 - 85	85	50	5	3.1	3.7	525									
	Orange	Blanc diffus	InGaAlP	70	20	4	-30 - 85	45	15	10	2	2.5	630									
24	Bleu	Blanc diffus	GaN	65	15	4	-30 - 85	30	18	5	3.1	3.7	470	P11593CT-ND	1.92	1.54	1.16	P11593TR-ND	2,000	999.42/M	LNJ717W80RA1	
	Vert pur	Blanc diffus	GaN	65	15	4	-30 - 85	85	50	5	3.1	3.7	525									
	Orange clair	Blanc diffus	InGaAlP	70	20	4	-30 - 85	45	20	10	1.95	2.5	615									
25	Bleu	Blanc diffus	GaN	65	15	4	-30 - 85	15	5	5	3.1	3.8	470	P14148CT-ND	1.08	.87	.66	P14148TR-ND	2,000	564.65/M	LNJ727W83RAA	
	Vert pur	Blanc diffus	GaN	65	15	4	-30 - 85	80	60	5	3.1	3.8	525									
	Orange	Blanc diffus	InGaAlP	55	20	4	-30 - 85	20	20	10	2	2.5	630									

♦ Conforme à RoHS ‡ DEL à faible courant, même luminosité que la conception précédente avec la moitié de la puissance, idéale pour les équipements alimentés par pile. † Type traversant la carte

Affichages numériques à DEL

P358-P360

Taille	Dim. A	Dim. B	Dim. C
.57	25.1	14.4	8.0

Couleur	Taille	Valeurs nominales absolues maximum (Ta = 25 °C)				Caractéristiques (Ta = 25 °C)				N° de référence Digi-Key Common Cathode	Prix			N° de référence Panasonic Common Cathode		
		V _R (V)	I _F (mA)	IFP† (mA)	PD (mW)	at I _F (mA)	Typ. ES (seg.) (µcd)	Typ (D.P.) (µcd)	V _F à I _F Typ. (V)		1	10	1 000			
Rouge	.57	5	20	100	60	5	600	250	20	2.2	P358-ND	1.74	15.88	273.16	1175.61	LN526FRK
Ambre	.57	5	20	100	60	10	800	300	20	2.2	P360-ND	2.52	22.87	393.35	1692.88	LN526YK

♦ Conforme à RoHS † La condition imposée par IFP est un service de 10 %, largeur d'impulsion de 1 ms.

Digi-Reel® La plupart des composants à découper à technologie CMS sont disponibles sur une Digi-Reel®. Pour obtenir la référence bobine Digi-Reel, remplacer 1-ND par 6-ND ou CT-ND par DKR-ND. Voir les services Digi-Key® en page 2 pour plus d'informations.

Livraison gratuite pour les commandes de plus de 65 € ! Tous les prix sont indiqués en euros.

fr.digikey.com — Téléphone (numéro vert) : 0800-161-113 — Téléphone : +31 (0)53-484-9584 — Télécopieur : +33 (0)38-717-0111

(FR091) 2541