



A Product Line of Diodes Incorporated



Medium Power Transistors 20-100 Volts (Cont.)



Table with columns: VCEO (V), VCB0 (V), IC (cont.) (A), hFE @ IC (mA) @ VCE (V), VCE (sat) @ IC (mA) @ IB (mA), Packaging Type, Digi-Key Part No., Cut Tape Price Each (1, 10), Digi-Key Part No., Tape and Reel Qty., Pricing. Includes sub-sections for PNP - RoHS Compliant and various transistor types like D-PAK, 3-MLP, etc.

RoHS Compliant Tape and Box

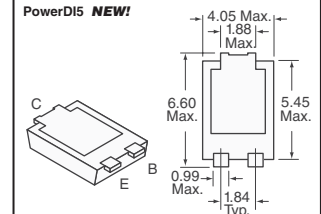
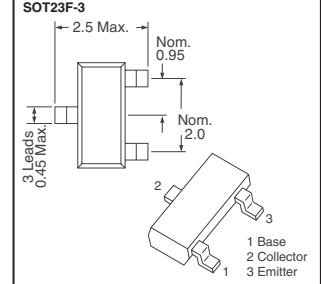
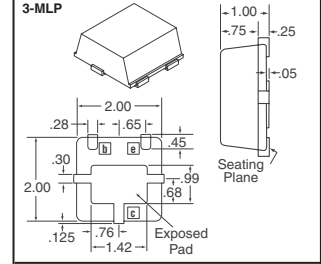
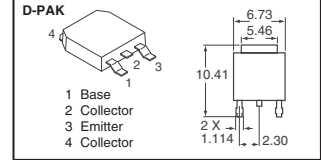
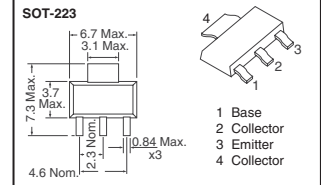
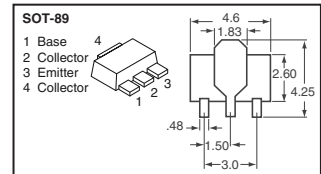

High Voltage Transistors 120-250 Volts



Table with columns: VCEO (V), VCB0 (V), IC (cont.) (A), hFE @ IC (mA) @ VCE (V), VCE (sat) @ IC (mA) @ IB (mA), Packaging Type, Digi-Key Part No., Loose Piece Pricing (1, 10, 100, 1,000). Includes sub-section for PNP - RoHS Compliant.

RoHS Compliant

(Continued)

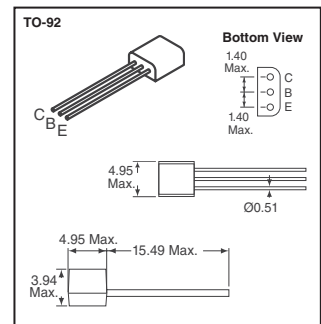

Digi-Reel Most SMT cutdown parts are available on a Digi-Reel. For Digi-Reel part number, change 1-ND to 6-ND or CT-ND to DKR-ND. See Digi-Key Services on page 2 for additional information.

Free shipping on orders over \$200 CAD! All prices in Canadian dollars and include duty and brokerage fees.

1246 (CA2011)

1-800-344-4539 • www.digikey.ca • 218-681-6674 • Fax: 218-681-3380